



Component Systems

for Lighting Applications



For Discharge Lamps

Ballasts, Ignitors, Power Switches, Capacitors and Lampholders

For Fluorescent Lamps

Ballasts, Capacitors, Lampholders, Starter Lampholders, Terminal Blocks and Accessories

For Incandescent Lamps

Transformers and Lampholders

For Emergency Lighting

Emergency lighting modules, Rechargeable Batteries and Supports

UPDATE!
Edition 2021

1	Vossloh-Schwabe Projects	4–5	3	Electronic Ballasts for TC and T Lamps	78–83
				For compact fluorescent lamps	80
				For tubular fluorescent lamps	81–83
2	Ballasts for Discharge Lamps	6–21	3	Electromagnetic ballasts for TC and T Lamps	84–90
	Electronic ballasts, accessories	8		For compact fluorescent lamps and tubular fluorescent lamps	86–90
	Luminaire protection device	9–14		Standard ballasts	86–89
	Electromagnetic ballasts	15–21		Super low-loss ballasts	90
	For HS and HI lamps	15–19			
	For HM and HI lamps	20–21			
2	Ignitors and Accessories for Discharge Lamps	22–38	3	Lampholders and Accessories for TC Lamps	92–100
	Electronic superimposed ignitors	24–32		2G7 lampholders	94
	Pulse ignitors	33–34		G23 lampholders	95–96
	Electronic power switches	35		2G11 lampholders	97
	Switch units for electronic operating devices with 1–10 V interface	36		Accessories	98–99
	Start-up switches	37		GX53-1 lampholders, accessories	100
	Electronic discharge units	38			
2	Lampholders for Discharge Lamps	40–49	3	Lampholders and Accessories for T Lamps	102–115
	E27 lampholders	42–44		G5 lampholders	104–107
	E40 lampholders	44–46		G5 lampholders, accessories	104–106
	GY9.5 lampholders	46		G5 lampholders, degree of protection	
	G12 lampholders	46–47		IP65/IP67	107
	RX7s lampholders	47–49		G13 lampholders	108–115
	K12x30s lampholders	49		G13 push-through lampholders	108
	K12s-7 support	49		G13 push-fit lampholders	109
				G13 push-fit twin lampholders	109
				G13 built-in lampholders	110–112
				G13 surface-mounted lampholders	112
				Accessories for T8 and T12 lamps	113
				G13 lampholders, degree of protection	
				IP65/IP67, accessories	114–115
2	Technical Details for Discharge Lamps	50–76	3	Starter Holders and Terminal Blocks, Accessories	116–122
				Starter holders	118
				Terminal blocks	119–121
				Built-in rocker switches	122
			3	Technical Details for Fluorescent Lamps	123–143
			4	Parallel Capacitors	144–155
				Parallel capacitors	146–147
				Technical details for parallel capacitors	148–155

5	Transformers for Low-voltage Halogen Incandescent Lamps	156–158	6	Emergency Lighting Modules for TC and T Lamps	216–226
	Independent electronic converters	158		Emergency lighting modules	
				with self-diagnosis function	218–219
				Technical details for emergency lighting modules	220–226
5	Lampholders for Low-voltage Halogen Incandescent Lamps	160–167	7	General Technical Details	228–236
	G4, GZ4, G5.3, GX5.3, G6.35, GY6.35 lampholders, accessories	162–163			
	Lampholders with separate mounting spring for GU4 lamps	164			
	GX5.3 lamp connectors	165			
	GU5.3 lampholders	165	8	Glossary	237–239
	Lampholders with separate mounting spring for GU5.3 lamps	166			
	G53 lamp connectors	167	9	Table of Reference Numbers and Approval Marks	240–246
5	Lampholders for Mains Voltage Halogen Incandescent Lamps	167–173			
	G9 lampholders, accessories	167–168			
	GU10, GZ10 lampholders, accessories	169–170			
	R7s ceramic lampholders	170–172			
	R7s metal lampholders	172			
	Connectors	173			
5	Lampholders for General-service Incandescent and Retrofit Lamps	174–204			
	E14 lampholders	176–183			
	E14 thermoplastic lampholders, one-piece and cover caps	176–179			
	E14 thermoplastic lampholders, three-piece	180–182			
	E14 metal lampholders, three-piece	182–183			
	E27 lampholders	184–199			
	E27 thermoplastic lampholders, one-piece and cover caps	184–188			
	E27 renovation kit lampholders	189			
	E27 thermoplastic lampholders, three-piece	189–192			
	E27 porcelain lampholders	193–194			
	E27 metal lampholders, three-piece	195			
	E27 metal pull-switch lampholders	196			
	E27 thermoplastic rocker switch lampholders	197			
	E27 festoon lampholders	198			
	B22d lampholders, accessories	199			
	Accessories for E14, E27 and B22d lampholders	200–203			
	E40 porcelain lampholders	204			
5	Technical Details for Incandescent Lamps	206–215			

LIGHT TECHNOLOGY PRODUCTS

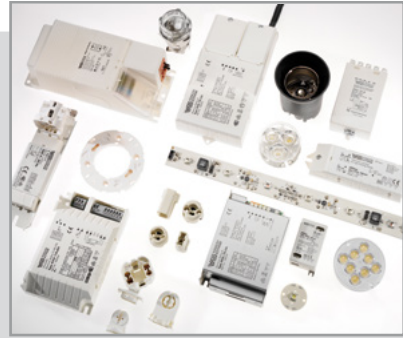

Vossloh-Schwabe is not merely a manufacturer of top-quality components for the lighting industry, but above all a competent and innovative partner when it comes to providing the growing lighting market with cost-effective all-round solutions.

Featuring a future-proof component structure that already now satisfies both the requirements of energy-efficient lighting and European standards, VS' unique product range includes magnetic and electronic ballasts, state-of-the-art control systems (Blu2Light and LiCS), LED lighting systems and matching operating devices.

Employing in excess of 500 people in more than 20 countries, Vossloh-Schwabe is represented all over the world. VS can draw on extensive resources for R&D as well as for international expansion activities. A highly motivated workforce, comprehensive market knowledge, profound industry expertise as well as eco-awareness and environmental responsibility show Vossloh-Schwabe to be a reliable partner for the provision of optimum and cost-effective lighting solutions.

Vossloh-Schwabe's dedication to delivering superior quality is reflected in its ISO 9001 certification.

Vossloh-Schwabe is ready to embark on a collaborative journey into an economically illuminated future.

LED components are just as much a part of our product range as light control systems. Our extensive range of powerful LED modules, LED drivers, Blu2Light and LiCS controllers and sensors is presented on our website

www.vossloh-schwabe.com.

We'll be happy to help you dimension your lighting project. Contact us.





PUMA Headquarters



Porsche Museum

1

2

3

4

5

6

7

8

9

10

PUMA Headquarters, Herzogenaurach

As the secret "capital of sport", the little German town of Herzogenaurach is home to the headquarters of the sport lifestyle company PUMA. Covering a total surface area of 50,000 square metres, the complex is made up of three buildings that are positioned so as to create a large central square, the PUMA Plaza.

The main aim of the lighting concept developed for the new PUMA corporate headquarters was to deliver optimum quality of light, enable maximum flexibility in using the available space and yield the greatest possible energy savings. No less than 985 electronic DALI ballasts and 4,650 standard electronic ballasts made by Vossloh-Schwabe went into implementing the lighting system.

The inner courtyard features additional red and white effect lighting in the form of ground-level linear markings created using LEDs made by Vossloh-Schwabe. These LEDs enable digital lighting sequences to flow over the square. To complement the clear-cut, rectilinear forms that characterise the entire building complex, a number of slender light columns, made of square aluminium sections, were installed to round off the courtyard's stylish appearance.

Photos: Markus Bollen

Porsche Museum, Stuttgart

The name "Porsche" both stands for a long tradition of outstanding quality and the excitement of high-octane driving. The Porsche Museum in Stuttgart constitutes a fitting presentation venue that does the brand image every justice. The architectural flagship thus serves to make the "Porsche experience" available to everyone.

The lighting installed in the Porsche Museum forms a crucial element of the exhibition space created for around 80 vehicles. It was important to ensure every detail of these high-end cars was clearly visible. In this regard, direct and reflecting lighting had to be reduced to an absolute minimum so as to neither irritate visitors, nor detract from the brilliant gloss of the bodywork.

This forms another instance in which Vossloh-Schwabe products have helped to add to the enjoyment of each and every visitor. Built-in electronic ballasts and electronic DALI safety converters ensure flicker-free, efficient light.

ELECTRONIC AND ELECTRO- MAGNETIC

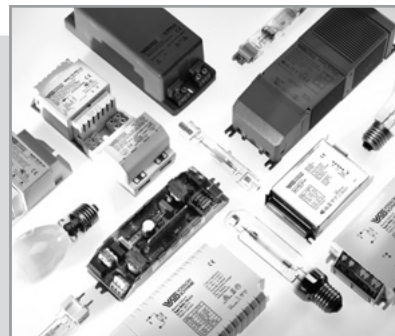

ELECTRONIC AND ELECTROMAGNETIC OPERATING DEVICES

For high-pressure sodium lamps (HS), metal halide lamps (HI) and mercury vapour lamps (HM)

Electronic ballasts

Modern discharge lamps operate very efficiently in combination with electronic ballasts. The numerous advantages of using electronic ballasts to operate high-pressure discharge lamps are listed in more detail on the product pages.

With the help of temperature and service-life tests, VS electronic ballasts guarantee a high degree of reliability. The quality of the electronic ballasts is ensured by continuous in-circuit tests and function tests like burn-in tests.

Magnetic ballasts

The electrical specifications of VS' range of ballasts comply with lamp-specific requirements. Vossloh-Schwabe attaches great importance to ensuring the impedance value of electromagnetic ballasts is kept within particularly narrow tolerances. This advantage, which is achieved by individual adjustment of the air gap during the automated production and testing process of every ballast, decisively contributes to optimising light output, light colour and service life of discharge lamps.

The range includes ballasts with variable voltage tapping points and varying degrees of inherent heating as well as encapsulated devices.



2

Ballasts for Discharge Lamps

For high-pressure sodium lamps (HS), metal halide lamps (HI) and mercury vapour lamps (HM)

Electronic ballasts, accessories	8
Luminaire protection devices	9-14
Electromagnetic ballasts	15-21
For HS and HI lamps	15-19
For HM and HI lamps	20-21
Technical details for discharge lamps	78-119
General technical details	228-236
Glossary	237-239

1

2

3

4

5

6

7

8

9

10

Electronic Ballasts for HI Lamps 35 and 70 W

Shape: M3/K34

- Casing: aluminium (M3),
heat-resistant polycarbonate (K34)
- For ceramic discharge tube lamps (C-HI)
- Power factor: ≥ 0.95
- Ignition voltage: max. 5 kV
- Operation frequency: 173 Hz
- Push-in terminals with lever opener: 0.75–2.5 mm²
- Total harmonic distortion: < 10%
- Temperature protection
- Constant power consumption
- Protection against "no load" operation
- For luminaires of protection class I (metal casing)
- For luminaires of protection class I and II (plastic casing)
- Degree of protection: IP20
- Permissible load capacity: 20–120 pF
- RFI-suppressed
- Fixing brackets for screws M4
for base mounting
- No flickering of defective lamps



K34 with cord grip

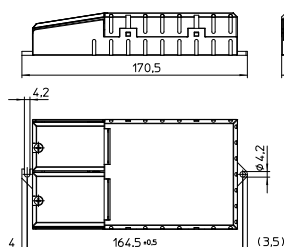

M3

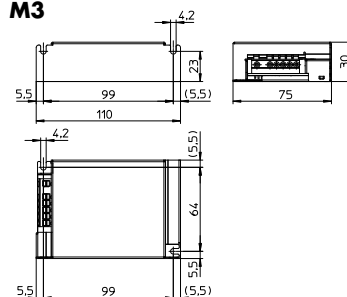

Lamp				Electronic ballast								System
Output W	Type	Base	Power consumption W	Type	Ref. No.	Voltage AC 50, 60 Hz V $\pm 10\%$	Mains current A	Energy efficiency	Ambient temperature t_a (°C)	Casing temperature t_c (°C)	Weight g	Output W
M3 – Electronic built-in ballast (with cap)												
35	HI	GU6.5, G8.5, GU8.5, GX8.5, G12, E27	1 x 39	EHXc 35.325	183033	220–240	0.20–0.18	A2	–20 to 65	max. 80	220	43
70	HI	G8.5, GU8.5, GX8.5, G12, PG12-2, E27, RX7s	1 x 73	EHXc 70.326	183036	220–240	0.36–0.34	A2	–20 to 55	max. 80	220	80
M3 Built-in PCB – Electronic built-in ballasts (without cap)												
35	HI	GU6.5, G8.5, GU8.5, GX8.5, G12, E27	1 x 39	EHXc 35.325	183034	220–240	0.20–0.18	A2	–20 to 65	max. 80	180	43
K34 – Independent electronic ballasts with cord grip												
35	HI	GU6.5, G8.5, GU8.5, GX8.5, G12, E27	1 x 39	EHXc 35.325	183035	220–240	0.20–0.18	A2	–20 to 65	max. 75	260	43
70	HI	G8.5, GU8.5, GX8.5, G12, PG12-2, E27, RX7s	1 x 73	EHXc 70.326	183038	220–240	0.36–0.34	A2	–20 to 55	max. 75	260	80

Circuit diagrams see page 56

Luminaire Protection Device

For electronic devices

When electronic components form part of lighting systems, it is often necessary to protect such components against power-supply interruptions and electric overloads (power surges).

These can be caused by switching inductive loads or by atmospheric discharges such as lightning striking the mains or the ground. A further cause can be induced voltages from neighbouring cables when working with leading-edge phase-cutting controls.

The protection unit reduces over-voltages at the connection terminals of electronic components. The remaining residual voltage is then reduced to a respective protective level, based on the discharge current.

SP 230/10 K

Suitable for luminaires of protection class II
Type 3 product
With integrated thermal fuse
Dimensions (LxWxH): 32x22x13 mm
Weight: 20 g
Connecting: solid wire, length: 50 mm

Ref. No.: 147230

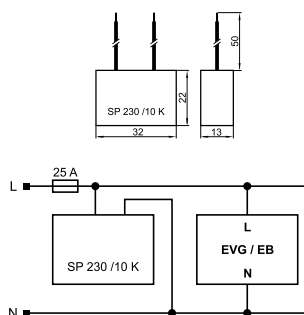

SPC 230/10 K

If the protective luminaire component overloads, the connected lighting circuit will be interrupted. This cut-out function makes it easier to detect the end of life of the protective component, facilitates quick replacement by maintenance staff and provides reliable protection for lighting components. Suitable for luminaires of protection class II
Type 3 product
Dimensions (LxWxH): 53x28x27 mm
Weight: 50 g
Screw terminals: 0.5–1.5 mm²

Ref. No.: 142736

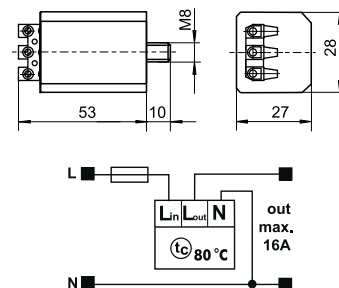

SP 3/230/10 K

Suitable for luminaires of protection class I
Type 3 product
Dimensions (ØxH): Ø 36x75 mm
Weight: 60 g
Screw terminals: 0.75–4 mm²

Ref. No.: 147233

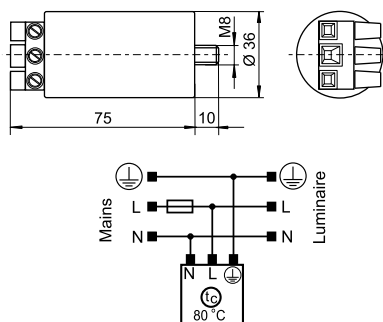

Type	Ref. No.	Voltage 50/60 Hz V ± 10 %	Max. load current A	Max. impulse voltage U _{OC} (V)	Discharge current* (8/20 µs) I _N (A) I _{max} (A)	Protection level at discharge current of 1000 A	Safety max. A	Max. permitted casing temperature (°C)	Min. permitted ambient temperature (°C)	Fixation
SP 230/10 K	147230	220–240	—	10000	5000 10000	≤ 850 V	25	80	–30	—
SPC 230/10 K	142736	220–240	16	10000	5000 10000	≤ 850 V	16	80	–30	M8x10
SP 3/230/10 K	147233	100–277	—	10000	5000 10000	≤ 1000 V	25	80	–30	M8x10

* Discharge current: at 5000 A min. 15 strikes; at 10,000 A min. 1 strike

Luminaire Protection Device – Type 3

For electronic devices

These protective components are fitted with an LED indicator. Once the end of the component's life has been reached, the green LED goes out and the protective component has to be replaced.

SP230/10 K/HS/i

The green LED light will go out if the protective function fails

Dimensions (LxWxH): 90x17.2x63 mm

Weight: 45 g

Screw terminals: 0.5–2.5 mm²

Fixation on DIN installation rail

Ref. No.: 147240

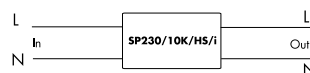
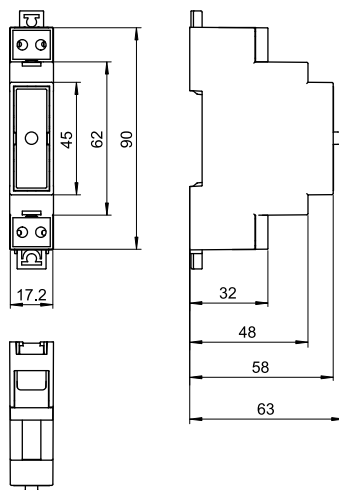

Type	Ref. No.	Voltage 50/60 Hz V ±10 %	Max. load current (A)	Protection level at discharge current of 1000 A	Max. impulse voltage U _{OC} (V)	Discharge current* (8/20 μs) I _N (A) I _{max.} (A)	Safety max. A	Max. permitted casing temperature °C	Fixation
SP230/10 K/HS/i	147240	220–240	16	≤ 1000 V	10000	5000 10000	16	–35 to 80	DIN-rail

* Discharge current: at 5000 A min. 15 strikes; at 10,000 A min. 1 strike

Luminaire Protection Device – Type 3

For electronic devices

These protective components are fitted with internal thermal fuses. The protective component will be disconnect from the mains at the end of the internal varistors' life or if there is a permanently overvoltage.

In that case the green LED goes out and the protective component has to be replaced.

AC-system: TTTN-IT
 Temporary overvoltage
 (TOV)-LV: 443 V AC (5 sec.) / 443 V (120 min.)
 (TOV)-MV/HV: 1200 V AC (200 msec.)
 I_{scrr} : 1000 A
 With integrated thermal fuse
 Dimensions (LxWxH): 79x45x35 mm

SP3/230/10K/i

Suitable for luminaires of protection class I

Push-in terminals: 0.5–2.5 mm²

Degree of protection: IP20

DEKRA approved acc. to EN 61643-11

Weight: 67/72 g

Ref. No.: 142743 without fixing threaded bolt

Ref. No.: 142744 with fixing threaded bolt



Powered by DEKRA

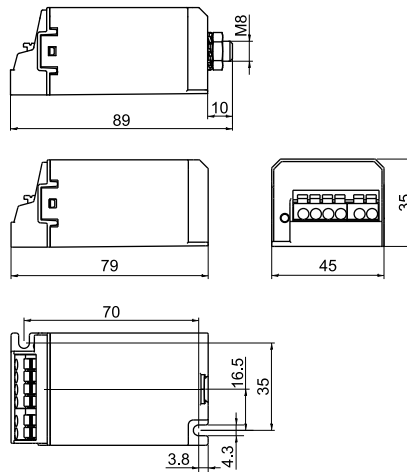

SPC3/230/20K/i

Suitable for luminaires of protection class I

Push-in terminals: 0.75–2.5 mm²

Degree of protection: IP20

Comply with the requirements of EN 61643-11

Weight: 55/60 g

Ref. No.: 142752 without fixing threaded bolt

Ref. No.: 142751 with fixing threaded bolt

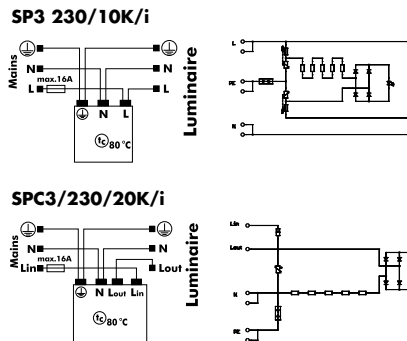

Type	Ref. No.	Voltage 50/60 Hz V ± 10 %	Max. load current A	Protection level			I _{pe} µA	Max. impulse voltage U _{oc} (V)	Discharge current* (8/20 µs)		Safety max. A	Max. permitted casing temp. °C	Fixing threaded bolt
				L-N (V)	L-PE (V)	N-PE (V)			I _N (A)	I _{max} (A)			
SP3/230/10 K/i	142743	100–277	16	< 1500	< 1800	< 1800	1	10000	5000	10000	16	–35 to 80	without
SP3/230/10 K/i	142744	100–277	16	< 1500	< 1800	< 1800	1	10000	5000	10000	16	–35 to 80	with
SPC3/230/20 K/i	142751	100–277	16	< 1500	< 2200	–	1	20000	10000	20000	16	–35 to 80	with
SPC3/230/20 K/i	142752	100–277	16	< 1500	< 2200	–	1	20000	10000	20000	16	–35 to 80	without

* Discharge current: at I_N min. 15 strikes; at I_{max}. 1 strike

One-phase Luminaire Protection Devices – Type 3 with Protection of Control Phase or DALI Interface

For electronic devices

These protective components are fitted with internal thermal fuses. The protective component will be disconnect from the mains at the end of the internal varistors' life or if there is a permanently overvoltage. In that case the green LED goes out and the protective component has to be replaced.

Suitable for luminaires of protection class I
 Dimensions (LxWxH): 79x45x35 mm
 Fixing threaded bolt on request
 Push-in terminals: 0.2–2.5 mm²
 Permitted casing temperature: –35 to 80 °C
 With integrated thermal fuse
 Fuse: max. 16 A
 Max. residual current (I_{PE}): 1 µA
 Degree of protection: IP20

AC-system: TT-TN-IT
 Temporary overvoltage
 • (TOV)-LV: 443 V AC (5 sec.) / 443 V (120 min.)
 • (TOV)-MV/HV: 1200 V AC (200 msec.)
 I_{scCR}: 1000 A

SPC3/230/10K/i LS

One-phase overvoltage protection for control phase
 Comply with the requirements of EN 61643-11
 Weight: 69/79 g

Ref. No.: 142755

SPC3/230/10K/i LS DI

With integrated coordination circuit

Ref. No.: 142756

SPC3/230/10K/i DALI

One-phase overvoltage protection for L, N, PE and for protection of DALI signal
 Comply with the requirements of EN 61643-11 and EN 61643-21

Weight: 57/67 g

Ref. No.: 142753

SPC3/230/10K/i DALI DI

With integrated coordination circuit

Ref. No.: 142754

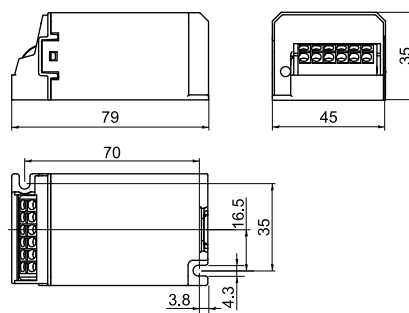

SPC3/230/10K/i LS

SPC3/230/10K/i DALI DI

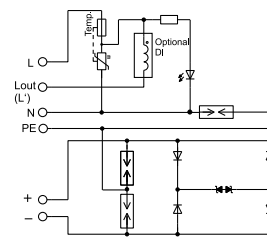
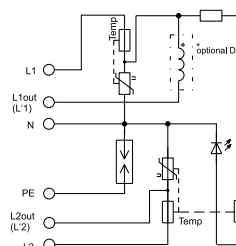

Type	Ref. No.	Voltage 50/60 Hz V ± 10 %	Max. load current A	Protection level			Max. impulse voltage U _{OC} (V)	Discharge current* (8/20 µs)		Protection voltage DALI		Capacity d+ to d- pF
				L-N (V)	L-PE (V)	L2-N (V)		I _N (A)	I _{max} (A)	d+ to d- Channel 1	d1/d2 to PE Channel 2	
SPC3/230/10K/i LS	142755	100–277	5	< 1500	< 1900	< 1600	10000	5000	10000	—	—	—
SPC3/230/10K/i LS DI	142756	100–277	2.5	< 1500	< 1900	< 1600	10000	5000	10000	—	—	—
SPC3/230/10K/i DALI	142753	100–277	5	< 1500	< 1900	—	10000	5000	10000	< 70	< 1000	< 20
SPC3/230/10K/i DALI DI	142754	100–277	2.5	< 1500	< 1900	—	10000	5000	10000	< 70	< 1000	< 20

* Discharge current: at I_N min. 15 strikes; at I_{max}. 1 strike

Integrated Coordination Circuit

In contrast to standard protective components, the SPC3...DI components feature an integrated coordination circuit. Coordination means that the highest share of the energy applied to luminaires in the form of high-voltage pulses is discharged, which in turn ensures the protective components within the LED driver are subjected to only minimal voltage loads. This coordination can be checked by carrying out a high-voltage test on the luminaires.

A decoupling inductor is also available as a separate product, which must be wired in between the protective component and the LED driver.

Type: DI-5A

Ref. No.: 149830



Luminaire Protection Device – Type 2 and 3

For electronic devices

These protective components are fitted with an LED indicator. Once the end of the component's life has been reached, the green LED goes out and the protective component has to be replaced. If the protective luminaire component overloads, the connected lighting circuit will be interrupted.

This cut-out function makes it easier to detect the end of life of the protective component, facilitates quick replacement by maintenance staff and provides reliable protection for lighting components.
 Dimensions (LxWxH): 76x34x27 mm
 Weight: 100 g, with integrated thermal fuse
 DEKRA approved acc. to EN 61643-11

AC system: TT-TN-IT
 Temporary overvoltage
 • (TOV)-LV: 443 V AC (5 sec.) / 443 V (120 min.)
 • (TOV)-MV/HV: 1200 V AC (200 msec.)
 I_{scrr}: 4500 A



SPC 230/10 K/i

Suitable for luminaires of protection class II
 Screw terminals: 0.75–2.5 mm²
 Degree of protection: IP20
Ref. No.: 142737

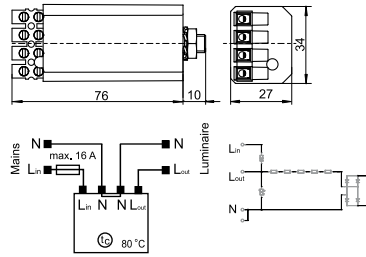

SPC 3/230/10 K/i

Suitable for luminaires of protection class I
 Screw terminals: 0.75–2.5 mm²
 Lead ground terminal: stranded conductors, 2.5 mm²,
 silicone insulation, length: 150 mm
 Degree of protection: IP20

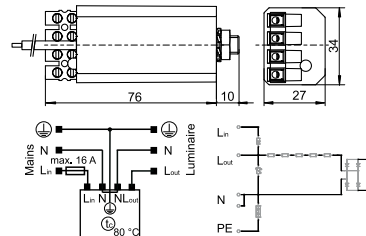

Ref. No.: 142738

Earthing wire with M4 ring-tongue

Ref. No.: 142742

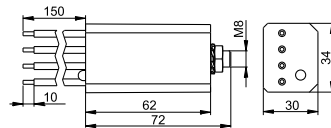

SPC 3/230/10 K/i-IP66

4 leads: stranded conductors, 2.5 mm²,
 silicone insulation, length: 150 mm
 Degree of protection: IP66

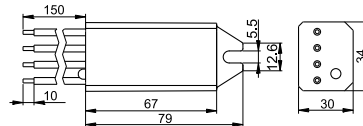

Ref. No.: 142748

Ref. No.: 142746 casing with fixing lug (no KEMA approval)
Ref. No.: 142747 with isolated cable with outer diameter approx. 12 mm (no KEMA approval)

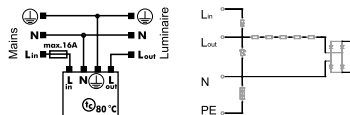
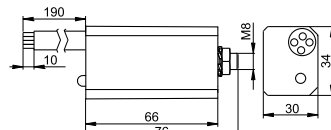

Type	Ref. No.	Voltage 50/60 Hz V ±10 %	Max. load current (A)	Protection level		I _{pe} μA	Max. impulse voltage U _{oc} (V)	Discharge current* (8/20 μs)		Safety max. A	Max. permitted casing temp. °C	Fixation
				L-N (V)	L-PE (V)			I _N (A)	I _{max.} (A)			
SPC 230/10 K/i	142737	100–277	16	< 1500	—	—	10000	5000	10000	16	–35 to 80	M8x10
SPC 3/230/10 K/i	142738	100–277	16	< 1500	< 1800	1	10000	5000	10000	16	–35 to 80	M8x10
SPC 3/230/10 K/i	142742	100–277	16	< 1500	< 1800	1	10000	5000	10000	16	–35 to 80	M8x10
SPC 3/230/10 K/i/IP66	142748	100–277	16	< 1500	< 1800	1	10000	5000	10000	16	–35 to 80	M8x10
SPC 3/230/10 K/i/IP66	142746	100–277	16	< 1500	< 1800	1	10000	5000	10000	16	–35 to 80	lug
SPC 3/230/10 K/i/IP66	142747	100–277	16	< 1500	< 1800	1	10000	5000	10000	16	–35 to 80	M8x10

* Discharge current: at 5000 A min. 1.5 strikes; at 10,000 A min. 1 strike

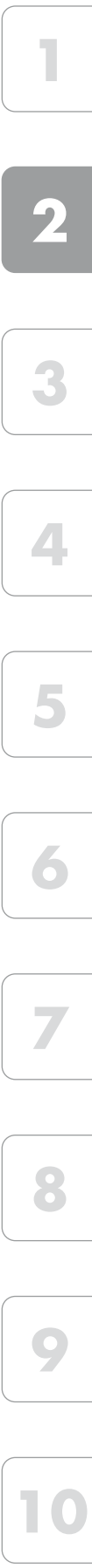

Inrush Current Limiter ESB

Limits capacitive inrush currents of electronic ballasts and LED drivers and converters

Due to their capacitive nature, electronic operating devices generate high inrush currents. By temporarily activating a limiting resistor, the inrush current is reduced to an uncritical value (see graph below).

Several electronic devices can be connected downstream under consideration of the maximum permissible continuous current of the inrush current limiter. As a result, the load per circuit breaker (MCB) can be increased by at least 2.5 fold.

The ESB thus prevents any automatic circuit breakers from being triggered or any damage from being caused to upstream relay contacts. Switching cycles: > 10,000

ESB-6K

Casing: PC
Dimensions (LxWxH): 55x28x27 mm
Weight: 61 g
Screw terminals: 0.5–1.5 mm²
VDE approved

Ref. No.: 149820
Ref. No.: 149822

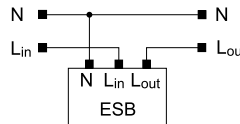
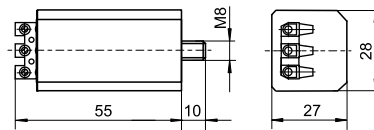

ESB-16HS

Casing: PC
Dimensions (LxWxH): 90x18x58 mm
Weight: 75 g
Screw terminals: 0.5–2.5 mm²
Ref. No.: 149821

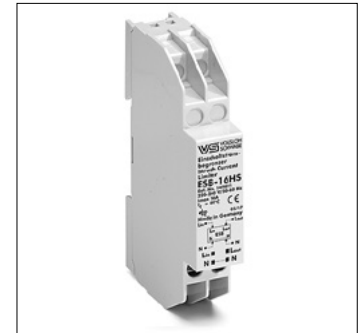
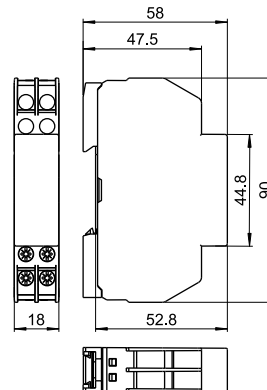
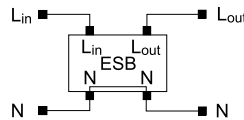

Type	Ref. No.	Nominal voltage 50–60 Hz V ± 10 %	Power consumption W	Max. direct current A	Limiting resistor Ω	Period of limitation ms	Max. permitted casing temperature (°C)	Min. permitted ambient temperature (°C)	Fixation
ESB-6K	149820	220–240	0.25	6	20	approx. 18	80	-30	M8x10
ESB-16HS	149821	220–240	0.6	16	11.2	approx. 18	80	-30	DIN-rail
ESB-6K_1A	149822	220–240	0.25	6	440	approx. 160	80	-30	M8x10

Example using a 150 W LED driver

Brown: with ICL (ESB)
Blue: without ICL (ESB)
1 V = 1 A

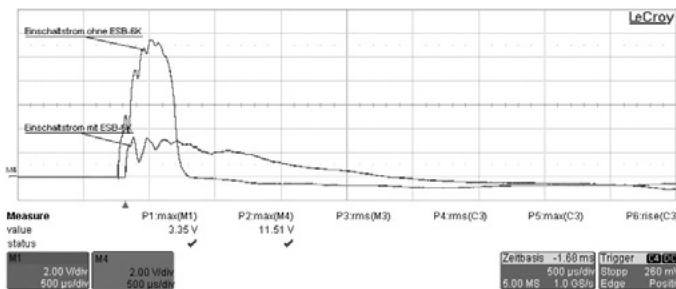

Standard Ballasts for HS and HI Lamps 35 to 250 W

Shape: 53x69 mm

For high pressure sodium lamps (HS),
metal halide lamps (HI) and
ceramic discharge lamps (C-HI)
Vacuum-impregnated with polyester resin
Screw terminals: 0.5–2.5 mm²
Protection class I
tw 130

Ballasts for pulse ignition system on request

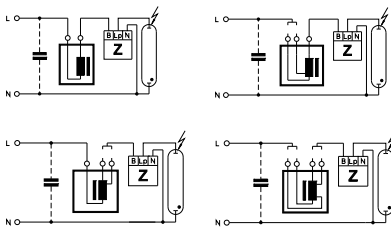
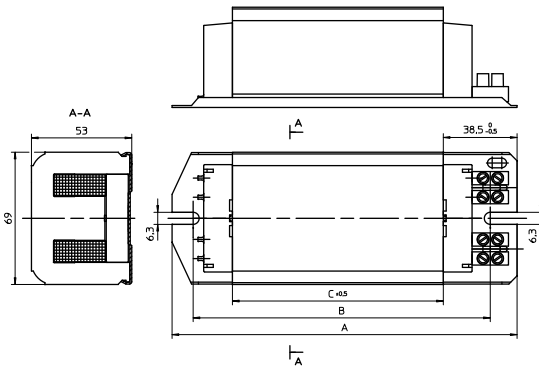
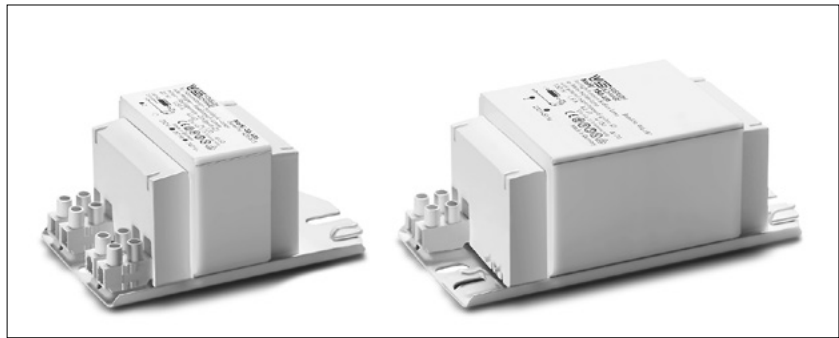

Lamp			Ballast											Capacitor	
Output W	Type	Current A	Type	Ref. No.	Voltage AC V, Hz	a mm	b mm	c mm	Weight kg	Δt K	Power factor λ	Energy efficiency	C _P μF	I _N A	
35	HS, HI	0.53	NaHJ 35.485*	571074	230/240, 50	112	86	31	0.98	60	0.40	EEI=A3	6	0.22/0.21	
			NaHJ 35.638	570961	220, 60	112	86	31	0.98	50	0.41	EEI=A3	5	0.23	
50	HS, HI	0.76	NaHJ 50.486*	571077	230/240, 50	112	86	36	1.07	65	0.37	EEI=A3	8	0.30/0.29	
			NaHJ 50.654	570958	220, 60	112	86	31	1.00	60	0.36	EEI=A3	8	0.31	
70	HS, HI	0.98	NaHJ 70.300	570977	220, 50	112	86	36	1.12	75	0.40	EEI=A3	12	0.40	
			NaHJ 70.128*	571008	230, 50	112	86	36	1.12	75	0.36	EEI=A3	12	0.38	
			NaHJ 70.128*	571022	230/240, 50	112	86	36	1.15	75	0.36	EEI=A3	12	0.38/0.37	
			NaHJ 70.128	571018	240, 50	112	86	36	1.15	75	0.37	EEI=A3	12	0.37	
			NaHJ 70.653	570962	220, 60	112	86	36	1.05	75	0.42	EEI=A3	10	0.40	
100	HS, HI	1.20	NaHJ 100.126	570997	220, 50	112	86	36	1.12	75	0.44	EEI=A3	12	0.55	
			NaHJ 100.941*	570964	230/240, 50	112	86	36	1.15	75	0.42	EEI=A3	12	0.55/0.53	
150	HS, HI	1.80	NaHJ 150.159	571004	220, 50	145	120	64	1.78	75	0.41	EEI=A3	20	0.80	
			NaHJ 150.620*	571013	230, 50	145	120	64	1.83	75	0.40	EEI=A3	20	0.77	
			NaHJ 150.620	571019	240, 50	145	120	64	1.85	75	0.40	EEI=A3	20	0.74	
			NaHJ 150.679	570999	220, 60	145	120	64	1.72	75	0.44	EEI=A3	16	0.80	
250	HS, HI	3.00	NaHJ 250.204	571006	220, 50	180	155	94	2.98	75	0.42	EEI=A3	32	1.32	
			NaHJ 250.915*	570963	230, 50	180	155	110	2.95	80	0.40	EEI=A3	32	1.26	
			NaHJ 250.340*	570982	230/240, 50	180	155	110	3.10	75	0.39	EEI=A3	32	1.26/1.21	
			NaHJ 250.340	570978	240, 50	180	155	110	3.10	80	0.39	EEI=A3	32	1.21	
			NaHJ 250.163	571249	220, 60	180	155	94	2.50	70	0.42	A2	25	1.35	

* Ballasts without CE marking for replacements or markets outside of the EU

Ballasts with Thermal Cut-out for HS and HI Lamps 35 to 250 W

Shape: 53x69 mm

For high pressure sodium lamps (HS), metal halide lamps (HI) and ceramic discharge lamps (C-HI)
 Vacuum-impregnated with polyester resin
 With temperature switch with automatic reset
 Protection class I
 tw 130

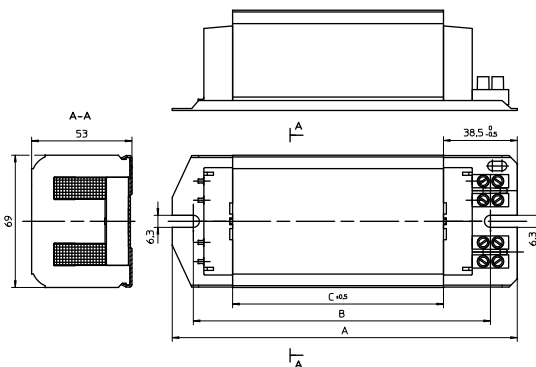
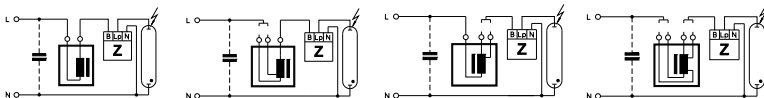
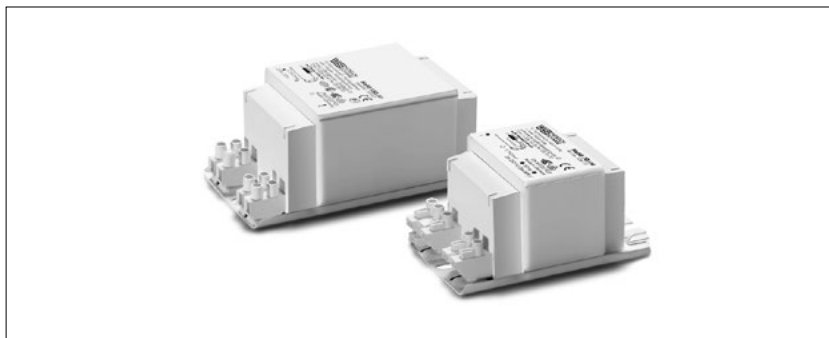

Lamp			Ballast										Capacitor	
Output W	Type	Current A	Type	Ref. No.	Voltage AC V, Hz	a mm	b mm	c mm	Weight kg	Δt K	Power factor (λ)	Energy efficiency	Cp μF	In A
Push-in terminals: 0.5–1.5 mm²														
35	HS, HI	0.53	NaHj 35.209	571076	230/240, 50	112	86	36	1.10	35	0.36	A2	6	0.22
			NaHj 35.485*	571075	230/240, 50	112	86	36	1.07	60	0.40	EEI=A3	6	0.22/0.21
50	HS, HI	0.76	NaHj 70/50.157*	571081	230, 50	112	86	42	1.23	55	0.37	EEI=A3	8	0.30
70	HS, HI	0.98								70	0.37	EEI=A3	12	0.38
70	HS, HI	0.98	NaHj 70.128*	571009	230, 50	112	86	36	1.12	75	0.36	EEI=A3	12	0.38
			NaHj 70.226	571011	230, 50	112	86	41	1.28	60	0.37	A2	12	0.38
			NaHj 70.158*	570995	230/240, 50	112	86	36	1.15	70	0.36	EEI=A3	12	0.38/0.37
150	HS, HI	1.80	NaHj 150.995*	570994	230/240, 50	145	120	64	1.84	75	0.40	EEI=A3	20	0.77/0.74
Screw terminals: 0.5–2.5 mm²														
50	HS, HI	0.76	NaH 50.486*	571078	230/240, 50	112	86	36	1.07	65	0.37	EEI=A3	8	0.30
50	HS, HI	0.76	NaHj 70/50.695*	571085	230/240, 50	112	86	48	1.23	50	0.37	EEI=A3	8	0.30/0.29
70	HS, HI	0.98								70	0.37	EEI=A3	12	0.38/0.37
70	HS, HI	0.98	NaHj 70.226	571012	230, 50	112	86	41	1.28	60	0.37	A2	12	0.38
			NaHj 70.128*	571010	230, 50	112	86	36	1.12	75	0.36	EEI=A3	12	0.38
			NaHj 70.158*	570975	230/240, 50	112	86	36	1.15	70	0.36	EEI=A3	12	0.38/0.37
			NaHj 70.128*	571020	230/240, 50	112	86	36	1.15	70	0.36	EEI=A3	12	0.38/0.37
100	HS, HI	1.20	NaHj 100.213	571031	230/240, 50	112	86	45	1.38	65	0.41	A2	12	0.55/0.53
			NaHj 100.941*	571028	230, 50	112	86	36	1.14	75	0.42	EEI=A3	12	0.55
			NaHj 100.941*	570980	230/240, 50	112	86	36	1.15	75	0.42	EEI=A3	12	0.55/0.53
100	HS, HI	1.20	NaHj 150/100.973*	571244	230, 50	145	120	75	2.02	55	0.41	A2	12	0.55
150	HS, HI	1.80								75	0.41	EEI=A3	20	0.77
150	HS, HI	1.80	NaHj 150.166	571025	230/240, 50	180	155	110	3.08	50	0.40	A2	20	0.77/0.74
			NaHj 150.620*	571015	230, 50	145	120	64	1.83	75	0.40	EEI=A3	20	0.77
			NaHj 150.995*	570974	230/240, 50	145	120	64	1.84	75	0.40	EEI=A3	20	0.77/0.74
			NaHj 150.620*	571023	230/240, 50	145	120	64	1.84	75	0.40	EEI=A3	20	0.77/0.74
250	HS, HI	3.00	NaHj 250.915*	570993	230, 50	180	155	110	2.95	80	0.40	EEI=A3	32	1.26

* Ballasts without CE marking for replacements or markets outside of the EU

Ballasts for HS and HI Lamps 250 to 1000 W

Shape: 91x104 mm

For high pressure sodium lamps (HS), metal halide lamps (HI) and ceramic discharge lamps (C-HI)
Vacuum-impregnated with polyester resin
Screw terminals: 0.75–2.5 mm²
Protection class I
tw 130

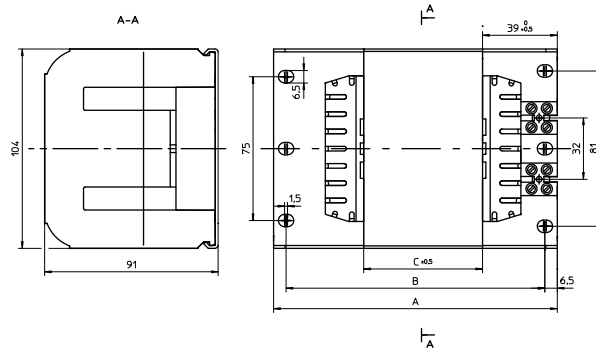
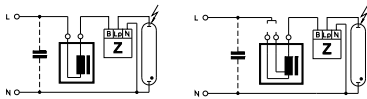

Lamp			Ballast										Capacitor	
Output W	Type	Current A	Type	Ref. No.	Voltage AC V, Hz	a mm	b mm	c mm	Weight kg	Δt K	Power factor λ	Energy efficiency	C _p μF	I _N A
250	HS, HI	3.00	NaHJ 250.727*	571042	230, 50	133	120	42	3.30	75	0.39	EEl=A3	32	1.26
			NaHJ 250.727	571049	240, 50	133	120	42	3.40	75	0.39	EEl=A3	32	1.21
400	HS, HI	4.45	NaHJ 400.006	571044	220, 50	148	135	62	4.57	75	0.44	A2	45	2.00
			NaHJ 400.006	571047	230, 50	148	135	62	4.57	80	0.44	A2	45	1.95
			NaHJ 400.737	571054	230/240, 50	148	135	62	4.7	75	0.45	A2	45	2.00/1.95
			NaHJ 400.737	571050	240, 50	148	135	62	4.61	80	0.43	A2	45	1.90
			NaHJ 400.012	571057	220, 60	148	135	68	4.45	75	0.44	A2	40	2.00
600	HS	6.20	NaH 600.010	571045	220, 50	173	160	96	6.78	75	0.44	A2	65	2.90
			NaH 600.005	571055	230/240, 50	173	160	96	6.89	75	0.44	A2	65	2.90/2.85
			NaH 600.140	571058	220, 60	173	160	96	6.79	75	0.46	A2	55	3.00
1000	HS	10.30	NaHJ 1000.089	571043	220, 50	248	235	160	11.31	75	0.47	A2	100	5.1
	HI	9.50							75	0.51	A2	85	5.0	
	HS	10.30	NaHJ 1000.089	571046	230, 50	248	235	160	11.4	75	0.45	A2	100	5.1
	HI	9.50							75	0.49	A2	85	5.0	
	HS	10.30	NaHJ 1000.089	571051	230/240, 50	248	235	160	11.57	75	0.45	A2	100	5.1
	HI	9.50							75	0.46	A2	85	5.0	
	HS	10.30	NaHJ 1000.089	571048	240, 50	248	235	160	11.45	75	0.42	A2	100	4.8
	HI	9.50							75	0.46	A2	85	4.9	
	HS	10.30	NaHJ 1000.089	571056	220, 60	248	235	160	11.13	75	0.46	A2	100	5.1
	HI	9.50							75	0.50	A2	85	5.0	

* Ballasts without CE marking for replacements or markets outside of the EU

With Thermal Cut-out

Thermal cut-out with automatic reset

Lamp			Ballast										Capacitor	
Output W	Type	Current A	Type	Ref. No.	Voltage AC V, Hz	a mm	b mm	c mm	Weight kg	Δt K	Power factor λ	Energy efficiency	C _p μF	I _N A
250	HS, HI	3.00	NaHJ 250.727*	571052	230/240, 50	133	120	42	3.40	75	0.39	EEl=A3	32	1.26/1.21
400	HS, HI	4.45	NaHJ 400.737	571053	230/240, 50	148	135	62	4.7	75	0.43	A2	45	1.95/1.90

* Ballasts without CE marking for replacements or markets outside of the EU

Ballasts for HI Lamps up to 2500 W

Shape: 150x150 mm

For metal halide lamps (HI)
 Vacuum impregnated with polyester resin
 Screw terminals: 0.75–4 mm²
 For luminaires of protection class I
 tw 130

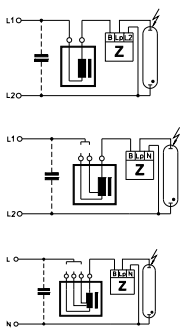

For Short Arc Lamps

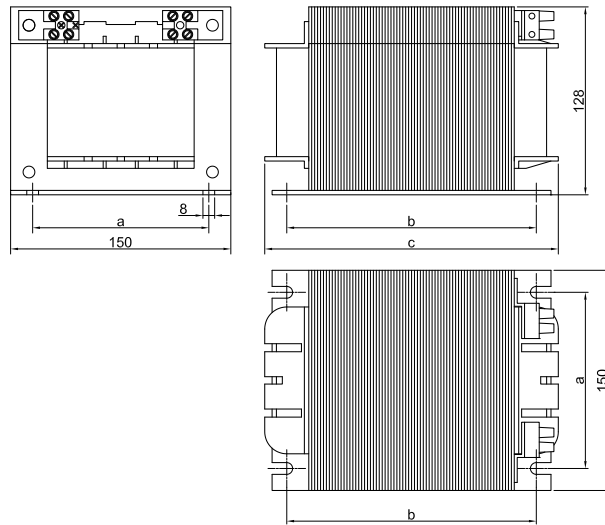

Lamp			Ballast										Capacitor	
Output W	Type	Current A	Type	Ref. No.	Voltage AC V, Hz	a mm	b mm	c mm	Weight kg	Δt K	Power factor λ	Energy efficiency	C _P μF	I _N A
2000	HI	8.8	J 2000.71	554303	380/400, 50	122	175	200	15	75	0.60	A2	37	6
			J 2000.72	554304	380/400/415, 50	122	135	160	14	70	0.58	A2	37	6
			J 2000.73	554305	380, 60	122	175	200	15	75	0.53	A2	30	6
2000	HI	10.3/11.3	JD 2000.81	554270	380/400, 50	122	175	200	15	80	0.53	A2	60	6
			JD 2000.81	554306	380/400/415, 50	122	135	160	14	75	0.52	A2	60	6
			JD 2000.83	554283	380, 60	122	175	200	15	75	0.54	A2	50	6
2000	HI	12.2	JD 2000III.91	554307	380/400, 50	122	175	200	16	80	0.46	A2	70	6
			JD 2000III.92	554308	380, 60	122	175	200	16	75	0.45	A2	60	6
2000	HI	16.5	JD 2000I.85	554309	230/240, 50	122	135	160	14	80	0.57	A2	125	10.5
			JD 2000I.86	554310	220, 60	122	135	160	14	80	0.57	A2	105	10
For Short Arc Lamps 1200 and 2500 W														
1200	HI	13.8	J 1200.95	554311	208, 60	122	105	130	11	-	0.40	A2	150	6
					230/245, 50									
2500	HI	25.6	J 2500.96	554312	208, 60	122	175	200	16	-	0.44	A2	260	12.3
					230/245, 50									

Ballast Units for HS and HI Lamps 1000 to 2000 W

Encapsulated in a plastic casing

For high-pressure sodium vapour lamps (HS) and metal halide lamps (HI)
Fully encapsulated ballast unit in a self-extinguishing, fibre-glass-reinforced polyamide casing consisting of a ballast, capacitor, fuse and a ready-to-use, pre-wired connection terminal.
Cable feed using a PG thread fitting

Degree of protection: IP65

With double insulation

Screw terminals: 0.75–10 mm²

Protection class II

tw 130

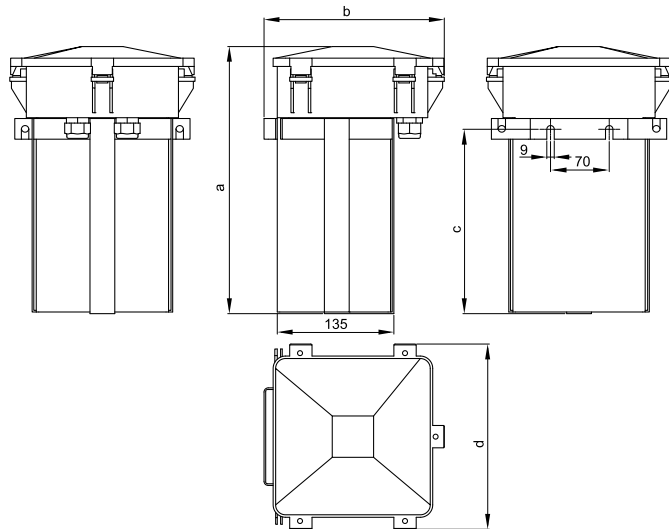

Lamp				Ballast unit									
Output W	Type	Current A	Mains current (A)	Type	Ref. No.	Voltage AC V, Hz	a mm	b mm	c mm	d mm	Weight kg	Power factor λ	Energy efficiency
230/240 V, 50 Hz and 380/400/415 V, 50 Hz													
1000	HS	10.3/11.3	5.75	VNaHJ 1000.75	554313	230/240, 50	288	217	—	220	15	> 0.90	A2
	HI	9.5	4.9										A2
2000	HI	8.8/9.2	5.7	VJ 2000.76	554314	380/400/415, 50	320	217	225	225	21	> 0.90	A2
		10.3/11.3	6.0	VJD 2000.77	554315	380/400/415, 50	320	220	225	225	23	> 0.90	A2
		12.2	6.0	VJD 2000I.78	554316	380/400/415, 50	320	220	225	225	25	> 0.90	A2
220 V, 60 Hz and 380 V, 60 Hz													
1000	HS	10.3/11.3	5.75	VNaHJ 1000.75	554904	220, 60	288	217	—	220	15	> 0.90	A2
	HI	9.5	4.9										A2
2000	HI	8.8/9.2	5.7	VJ 2000.76	554905	380, 60	320	220	225	225	21	> 0.90	A2
		10.3/11.3	6.0	VJD 2000.77	554906	380, 60	320	220	225	225	23	> 0.90	A2
		12.2	6.0	VJD 2000I.78	554909	380, 60	320	220	225	225	25	> 0.90	A2

Ballasts for HM and HI Lamps 50 to 400 W

Shape: 53x69 mm

For mercury vapour lamps (HM) and metal halide lamps (HI) with ignition voltage 1 kV
Vacuum-impregnated with polyester resin
Screw terminals: 0.5–2.5 mm²
Protection class I
tw 130

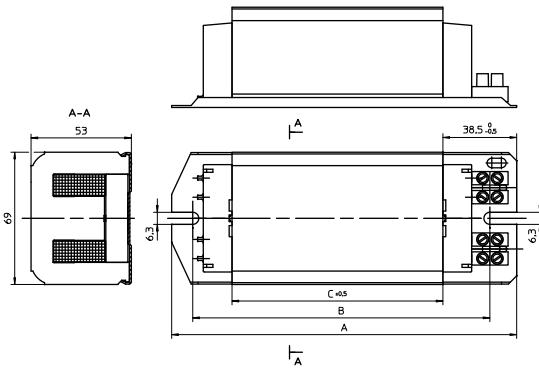
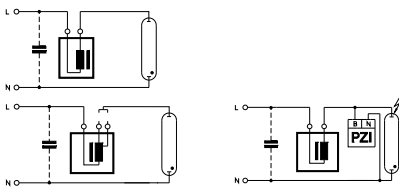
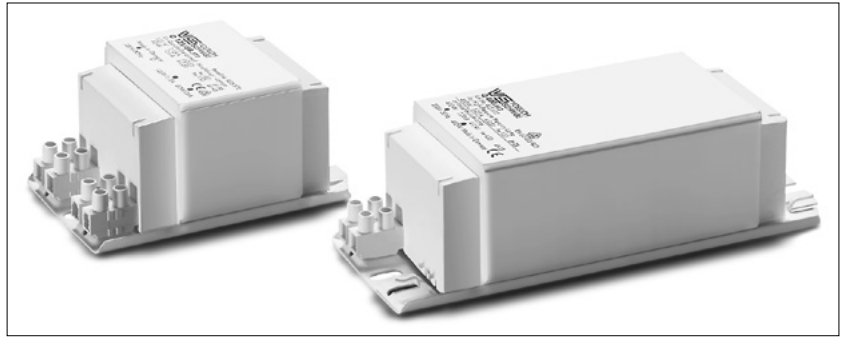

Lamp			Ballast											Capacitor	
Output W	Type	Current A	Type	Ref. No.	Voltage AC V, Hz	a mm	b mm	c mm	Weight kg	Δt K	Power factor λ	Energy efficiency	C _p μF	I _N A	
50	HM	0.61	Q 80/50.551*	570968	230, 50	112	86	31	1.00	55	0.43	EEl=A3	7	0.27	
80	HM	0.80								70	0.51	EEl=A3	8	0.41	
80	HM	0.80	Q 80.510	570965	240, 50	112	86	31	1.00	60	0.48	EEl=A3	8	0.40	
			Q 80.584	570970	220, 60	112	86	31	0.91	55	0.51	EEl=A3	7	0.43	
80	HM	0.80	Q 125/80.611*	571080	230, 50	112	86	42	1.22	50	0.49	EEl=A3	8	0.41	
125	HM	1.15								70	0.54	EEl=A3	10	0.60	
125	HM	1.15	Q 125.549	570976	220, 50	112	86	31	0.94	75	0.56	EEl=A3	10	0.63	
			Q 125.568*	570969	230, 50	112	86	36	1.10	75	0.54	EEl=A3	10	0.60	
			Q 125.512	570966	240, 50	112	86	36	1.10	75	0.51	EEl=A3	10	0.58	
			Q 125.598	570981	220, 60	112	86	31	0.94	75	0.57	EEl=A3	10	0.65	
250	HM	2.13	Q 250.513	570967**	220, 50	145	120	64	1.84	75	0.58	A2	18	1.26	
			Q 250.528	570972**	230, 50	145	120	64	1.86	75	0.56	A2	18	1.20	
			Q 250.703	570996**	240, 50	145	120	64	1.87	75	0.53	A2	18	1.15	
			Q 250.606	571003**	220, 60	145	120	64	1.75	75	0.58	A2	15	1.30	
400	HM	3.25	Q 400.616	571000**	220, 50	180	155	110	2.94	75	0.60	EEl=A3	25	2.00	
			Q 400.612	570971**	230, 50	180	155	110	3.00	75	0.56	A2	25	1.90	
			Q 400.669	570973**	240, 50	180	155	110	3.07	75	0.54	A2	25	1.85	
			Q 400.613	570998**	220, 60	180	155	94	2.54	75	0.60	A2	25	2.00	

* Ballasts without CE marking for replacements or markets outside of the EU

** Suitable for metal halide lamps (HI) with ignition voltage 1 kV in combination with pulse ignitor PZI 1000/1 K

Ballasts for HM and HI Lamps 1000 W

Shape: 91x104 mm

For mercury vapour lamps (HM) and metal halide lamps (HI) with ignition voltage 1 kV
Vacuum-impregnated with polyester resin

Screw terminals: 0.75–2.5 mm²

Protection class I
tw 130

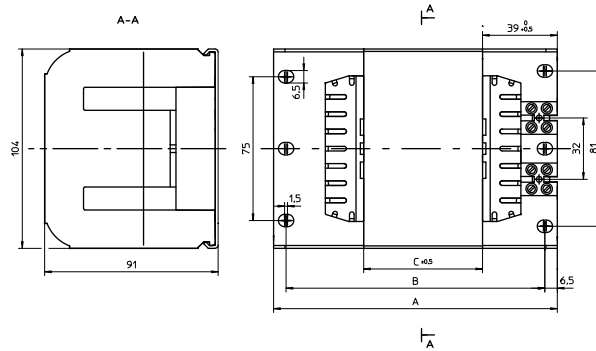
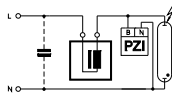
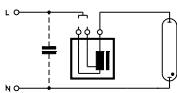
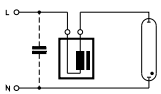

Lamp			Ballast										Capacitor	
Output W	Type	Current A	Type	Ref. No.	Voltage AC V, Hz	a mm	b mm	c mm	Weight kg	Δt K	Power factor λ	Energy efficiency	C _p μF	I _N A
1000	HM	7.50	Q 1000.097	571257*	220, 50	173	160	96	6.97	75	0.61	A2	60	4.80
			Q 1000.096	571255*	230, 50	173	160	96	6.94	75	0.60	A2	60	4.80
			Q 1000.145	571256*	240, 50	173	160	96	6.90	75	0.58	A2	60	4.60
			Q 1000.311	571254*	220, 60	173	160	96	6.74	75	0.61	A2	50	5.00

* Suitable for metal halide lamps (HI) with ignition voltage 1 kV in combination with pulse ignitor PZI 1000/1 K

1

2

3

4

5

6

7

8

9

10

SUPERIMPOSED AND PULSE IGNITION

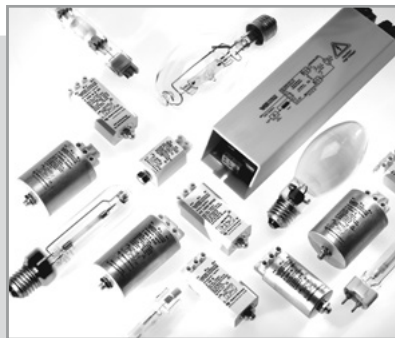

ELECTRONIC IGNITORS

Superimposed ignitors

Superimposed ignitors work independently of ballasts and generate defined ignition pulses during every half-wave within the stipulated voltage ranges. As the mains frequency only plays a subordinate role, these systems work equally well at 50 Hz and 60 Hz.

Superimposed ignitors should be mounted near the lampholder. The clearance needed between the ignitor and the lamp is determined by the respective maximum load capacitance, which is specified for each ignitor in the technical details. The capacitive load of the cable is dependent on its physical properties and wiring layout; this value usually ranges between 70–100 pF per metre.

Pulse ignitors

As pulse ignitors use the winding of an inductive ballast to generate the requisite pulse voltage, such ballasts must be designed to withstand these high ignition voltages.

On the following pages, Vossloh-Schwabe presents an extensive range of ignitors for all areas of application.



2

Ignitors and Accessories for Discharge Lamps

Electronic superimposed ignitors	24-32
Pulse ignitors	33-34
Electronic power switches	35
Switch units for electronic operating devices with 1-10 V interface	36
Start-up switches	37
Electronic discharge units	38
Technical details for discharge lamps	78-119
General technical details	228-236
Glossary	237-239

1

2

3

4

5

6

7

8

9

10

Electronic Superimposed Ignitors for HS Lamps up to 70 W

Standard version or with automatic switch-off
 For high pressure sodium lamps (HS) and ceramic discharge lamps C-HI-TT/ET with base E27
 Phasing of the ignition voltage:
 60–90 °el and 240–270 °el
 Max. permitted casing temperature: 105 °C
 Fastening: male nipple with pre-assembled washer and nut
 For luminaires of protection class I and II



Al casing

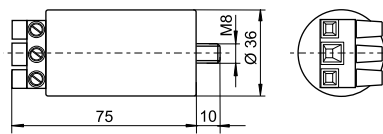

PC casing – K

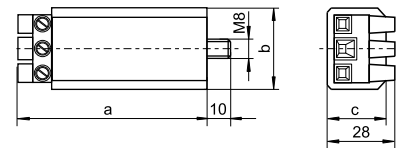

PC casing – K D20

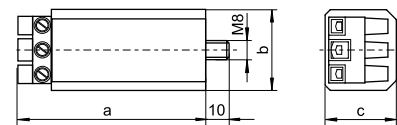

PC casing – with push-in terminals

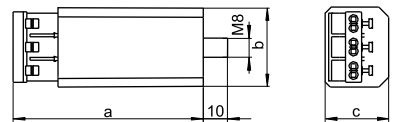

Type	Ref. No.	Voltage AC 50–60 Hz V	Max. lamp A	Internal loss W	Inherent heating K	Ignition voltage kV	Load capacity pF	Switch-off time sec./Hz	Casing d (∅)	a	b	c	Weight
									mm	mm	mm	mm	g
Aluminium casing (Al) with screw terminals: 0.75–4 mm²													
Z 70 S	140413	220–240	2	< 0.6	< 5	1.8–2.3	20–200	—	35	76	—	—	135
Plastic casing (PC) with screw terminals: 0.75–4 mm²													
Z 70 K	140481	220–240	2	< 0.6	< 5	1.8–2.3	20–200	—	—	78	34	27	125
Z 70 K D20	141580*	220–240	2	< 0.6	< 5	1.8–2.3	20–100	1216/50–60	—	80	34	30	145
Plastic casing (PC) with push-in terminals: 0.5–2.5 mm²													
Z 70 K D20	142330*	220–240	2	< 0.6	< 5	1.8–2.3	20–100	1216/50–60	—	83	34	30	145

* With IPP technology

Electronic Superimposed Igniters for HS Lamps 70 (DE) to 250 W and HI Lamps 35 to 250 W

Standard version or with automatic switch-off
 For high pressure sodium lamps (HS),
 metal halide lamps (HI) and
 ceramic discharge lamps (C-HI)
 Phasing of the ignition voltage:
 60–90 °el and 240–270 °el
 Max. permitted casing temperature: 105 °C
 Fastening: male nipple with pre-assembled
 washer and nut
 For luminaires of protection class I and II



Al casing

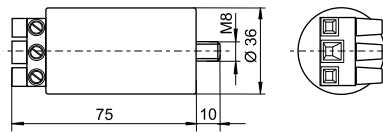

PC casing – K

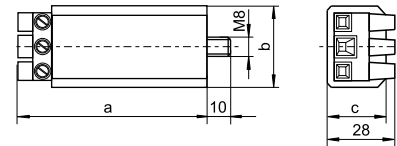

PC casing – K D20

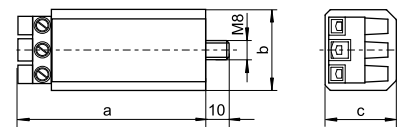

PC casing – with push-in terminals

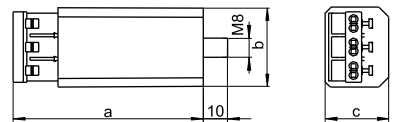

Type	Ref. No.	Voltage AC 50–60 Hz V	Max. lamp current A	Internal loss W	Inherent heating K	Ignition voltage kV	Load capacity pF	Switch-off time sec./Hz	Casing			Weight g	
									d (∅) mm	a mm	b mm		c mm
Aluminium casing (Al) with screw terminals: 0.75–4 mm²													
Z 250 S	140425	220–240	3.5	< 1.8	< 20	4–5	20–100	—	35	76	—	—	140
Plastic casing (PC) with screw terminals: 0.75–4 mm²													
Z 250 K	140489	220–240	3.5	< 1.8	< 20	4–5	20–100	—	—	78	34	27	130
Z 250 K D20	141581*	220–240	3.5	< 1.8	< 20	4–5	20–100	1216/50–60	—	80	34	30	145
Plastic casing (PC) with push-in terminals: 0.5–2.5 mm²													
Z 250 K D20*	142350*	220–240	3.5	< 1.8	< 20	4–5	20–100	1216/50–60	—	83	34	30	145

* With IPP technology

Electronic Superimposed Ignitors for HS Lamps 70 (DE) to 400 W and HI Lamps 35 to 400 W



Standard version or with automatic switch-off
 For high pressure sodium lamps (HS),
 metal halide lamps (HI) and
 ceramic discharge lamps (C-HI)
 Phasing of the ignition voltage:
 60–90 °el and 240–270 °el
 Max. permitted casing temperature: 105 °C
 Screw terminals: 0.75–4 mm²
 Fastening: male nipple with pre-assembled
 washer and nut
 For luminaires of protection class I and II

Al casing

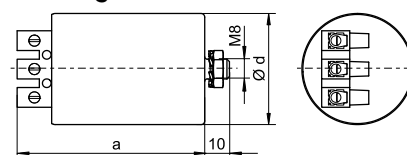

Type	Ref. No.	Voltage AC 50–60 Hz V	Max. lamp current A	Internal loss W	Inherent heating K	Ignition voltage kV	Load capacity pF	Switch-off time sec./Hz	Casing			Weight g	
									d (Ø) mm	a mm	b mm		c mm
Aluminium casing (Al)													
Z 400 S	140427	220–240	5	< 3	< 25	4–5	20–100	—	45	76	—	—	250
Z 400 S D20	141583*	220–240	5	< 3	< 25	4–5	20–100	1216/50–60	45	90	—	—	280

* With IPP technology

Electronic Superimposed Ignitors for HS Lamps 70 (DE) to 400 W and HI Lamps 35 to 400 W

Standard version or with automatic switch-off
Compact shape

For high pressure sodium lamps (HS),
metal halide lamps (HI) and
ceramic discharge lamps (C-HI)

Ignition voltage: 4–5 kV

Phasing of the ignition voltage:

60–90 °el and 240–270 °el

Max. permitted casing temperature: 105 °C

Fastening: male nipple with pre-assembled
washer and nut

For luminaires of protection class I and II

For luminaires of protection class I

(140594, 147707)

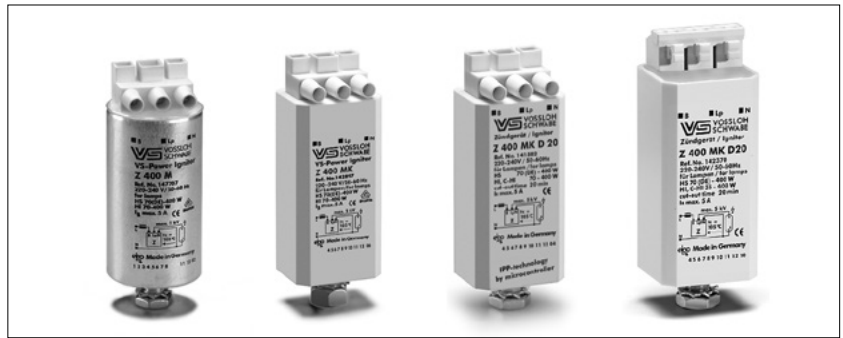

Al casing

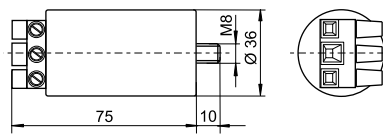

PC casing - K

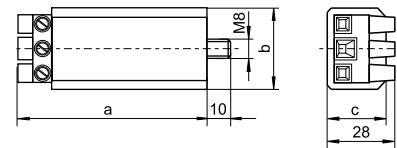

PC casing - K D20

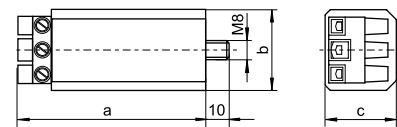

PC casing - with push-in terminals

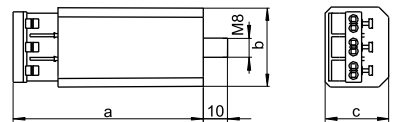

Type	Ref. No.	Voltage AC 50–60 Hz V	Max. lamp current A	Internal loss W	Inherent heating K	Ignition voltage kV	Load capacity pF	Switch-off time sec./Hz	Casing d (∅)	a	b	c	Weight g
Aluminium casing (Al) with screw terminals: 0.75–4 mm²													
Z 400 M	140594	220–240	5	< 3	< 35	4–5	20–50	—	35	76	—	—	140
Z 400 M VS-Power	147707**	220–240	5	< 3	< 35	4–5	20–50	—	35	76	—	—	140
Z 400 M S	140693	220–240	5	< 3	< 35	4–5	20–50	—	35	76	—	—	140
Plastic casing (PC) with screw terminals: 0.75–4 mm²													
Z 400 M K	140597	220–240	5	< 3	< 35	4–5	20–50	—	—	78	34	27	130
Z 400 M K VS-Power	142897**	220–240	5	< 3	< 35	4–5	20–50	—	—	78	34	27	130
Z 400 M K D20	141582*	220–240	5	< 3	< 35	4–5	20–50	1216/50–60	—	80	34	30	145
Plastic casing (PC) with push-in terminals: 0.5–2.5 mm²													
Z 400 M K D20	142370*	220–240	5	< 3	< 35	4–5	20–50	1216/50–60	—	83	34	30	145

Recommended for outdoor lighting

* With IPP technology

** Not suitable for C-HI lamps

Electronic Superimposed Ignitors for HS Lamps 600 and 750 W

Standard version

For high pressure sodium lamps (HS)

Phasing of the ignition voltage:

60–90 °el and 240–270 °el

Max. permitted casing temperature: 105 °C

Screw terminals: 0.75–4 mm²

Fastening: male nipple with pre-assembled washer and nut

For luminaires of protection class I and II



Al casing

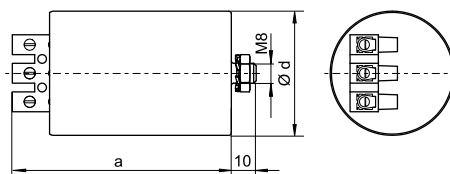

Type	Ref. No.	Voltage AC 50–60 Hz V	Max. lamp current A	Internal loss W	Inherent heating K	Ignition voltage kV	Load capacity pF	Switch-off time sec./Hz	Casing				Weight g
									d (Ø) mm	a mm	b mm	c mm	
Aluminium casing (Al)													
Z 750 S	146990	220–240	8	< 3	< 20	4–5	20–100	—	50	90	—	—	360

Electronic Superimposed Ignitors for HS and HI Lamps 250 to 1000 W

Standard version or with automatic switch-off
 For high pressure sodium lamps (HS) and metal halide lamps (HI)
 Phasing of the ignition voltage: 60–90 °el and 240–270 °el
 Max. permitted casing temperature: 105 °C
 Screw terminals: 0.75–2.5 mm²
 (Z 1000 S: 0.75–4 mm²)
 Fastening: male nipple with pre-assembled washer and nut
 For luminaires of protection class I and II



Al casing

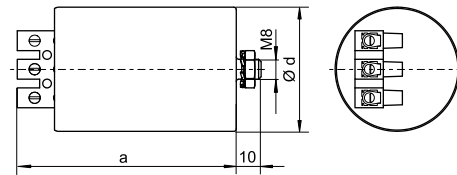

Z 1000 TOP

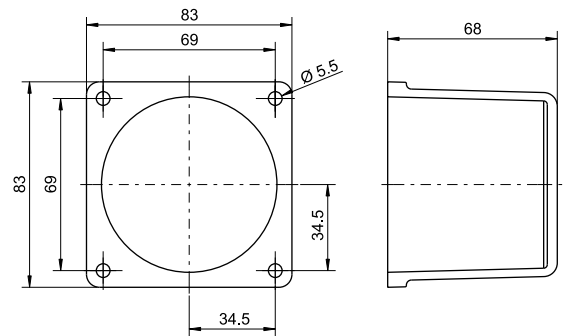

Type	Ref. No.	Voltage AC 50–60 Hz V	Max. lamp current A	Internal loss W	Inherent heating K	Ignition voltage kV	Load capacity µF	Switch-off time sec./Hz	Casing			Weight g	
									d (Ø) mm	a mm	b mm		c mm
Aluminium casing (Al)													
Z 1000 S	140430	220–240	12	< 6	< 35	4–5	20–100	—	50	80	—	—	340
Z 1000 TOP	140607**	220–240	12	< 6	< 35	4–5	20–100	—	—	83	83	68	620
Z 1000 S D20	141584*	220–240	12	< 6	< 35	4–5	20–100	1216/50–60	50	80	—	—	340

* With IPP technology

** For flange-mounting with gasket for degree of protection IP55

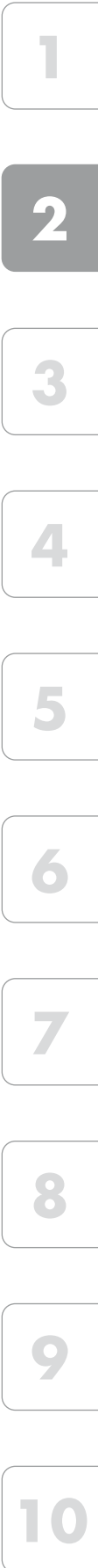

Electronic Superimposed Ignitors for HS and HI Lamps up to 1000 W



Standard version

For high pressure sodium lamps (HS) and metal halide lamps (HI)

For long lead lengths

Max. permitted casing temperature: 105 °C

Screw terminals: 0.75–2.5 mm²

Fastening: male nipple with pre-assembled washer and nut

Al casing

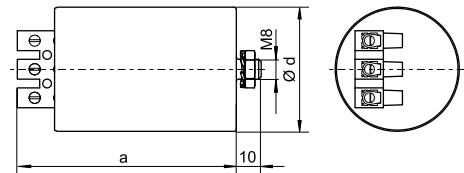

For HS and HI lamps 150 to 1000 W

Phasing of the ignition voltage: 60–90 °el

For luminaires of protection class I

Type	Ref. No.	Voltage AC 50–60 Hz V	Max. lamp current A	Internal loss W	Inherent heating K	Ignition voltage kV	Load capacity pF	Switch-off time sec./Hz	Casing				Weight g
									d (∅) mm	a mm	b mm	c mm	
Aluminium casing (Al)													
Z 1000 L	140471*	220–240	12	< 6	< 35	4–5	20–2000	—	50	97	—	—	340

* Not suitable for HI lamps types NDL, WDL or for HS lamps types S, de-Luxe, Comfort or similar

For HS lamps 600 to 1000 W/400 V and HI lamps 1000 W/400 V

Phasing of the ignition voltage:

60–90 °el and 240–270 °el

For luminaires of protection class I and II

Type	Ref. No.	Voltage AC 50–60 Hz V	Max. lamp current A	Internal loss W	Inherent heating K	Ignition voltage kV	Load capacity pF	Switch-off time sec./Hz	Casing				Weight g
									d (∅) mm	a mm	b mm	c mm	
Aluminium casing (Al)													
Z 1000 S/400 V	140496	380–415	6	< 3.3	< 28	4–5	20–2000	—	45	84	—	—	295

Electronic Superimposed Ignitors for Projection Lamps up to 1200 W

Standard version

For high-pressure discharge lamps

Phasing of the ignition voltage:

60–90 °el and 240–270 °el

Max. permitted casing temperature: 105 °C

Screw terminals: 0.75–2.5 mm²

Fastening: male nipple with pre-assembled washer and nut

For luminaires of protection class I



Al casing

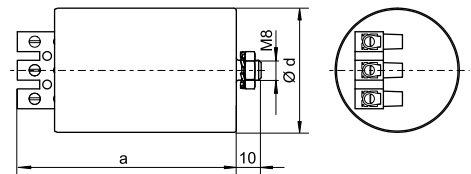

Type	Ref. No.	Voltage AC 50–60 Hz V	Max. lamp current A	Internal loss W	Inherent heating K	Ignition voltage kV	Load capacity pF	Switch-off time sec./Hz	Casing				Weight g
									d (Ø) mm	a mm	b mm	c mm	
Aluminium casing (Al)													
Z 1200/2.5	140608*	220–240	15	< 7.5	< 40	2–2.5	20–200	–	50	80	–	–	330
Z 1200/9	140609**	220–240	15	< 10	< 40	7–8	20–50	–	50	135	–	–	650

* For lamps, e.g. HSR, MSR, SN

** For lamps, e.g. HMI, HTI, CDI, RSI, CSR

Electronic Superimposed Ignitors for HI Lamps up to 3500 W

Standard version

For metal halide lamps (HI)

Phasing of the ignition voltage:

60–90 °el and 240–270 °el

Max. permitted casing temperature: 105 °C

Screw terminals: 0.75–2.5 mm²

Fastening: male nipple with pre-assembled washer and nut

For luminaires of protection class I and II

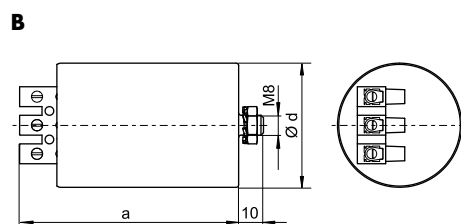
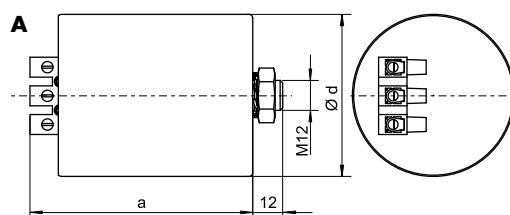

Type	Ref. No.	Voltage AC 50–60 Hz V	Max. lamp current A	Internal loss W	Inherent heating K	Ignition voltage kV	Load capacity pF	Switch-off time sec./Hz	Drawing	Casing			Weight g	
										d (Ø) mm	a mm	b mm		c mm
Aluminium casing (Al)														
Z 2000 S	140432	220–240	20	< 6	< 30	4–5	20–100	—	A	65	96	—	—	640
Z 2000 S/400 V	140497	380–415	12.7	< 5	< 32	4–5	20–2000	—	B	50	88	—	—	340
Z 3500 S/400 V	140499	380–415	20	< 7	< 35	4–5	20–100	—	A	65	96	—	—	650

Pulse Ignitors for HS and HI Lamps up to 1000 W

With automatic switch-off
 For high pressure sodium lamps (HS),
 metal halide lamps (HI) and
 ceramic discharge lamps (C-HI)
 Max. permitted casing temperature: 95 °C
 Screw terminals: 0.75–2.5 mm²
 Fastening: male nipple with pre-assembled
 washer and nut
 For luminaires of protection class I
 This pulse ignitor is only for use with ballasts that
 have a dedicated tapping, as this determines the
 size of the ignition voltage.



Al casing

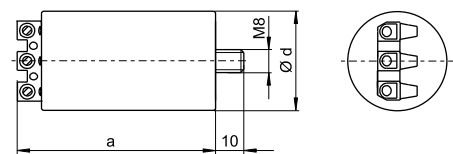

PC casing

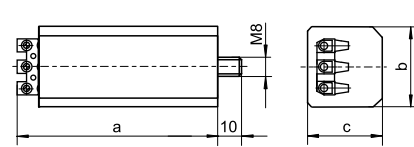

For HS lamps 50 to 1000 W, HI lamps 35 to 1000 W and C-HI lamps 35 to 400 W

Type	Ref. No.	Voltage AC 50–60 Hz V	Number of ignition pulses per mains period	Ignition voltage kV	Load capacity pF	Programmed switch-off time sec./Hz	Casing			Weight g
							a mm	b mm	c mm	
Plastic casing (PC)										
PZ 1000 K D20	142784*	220–240 ±10%	≥ 2	1.8–2.3/4–5	20–1000	1216/50–60	74	34	27	100

With IPP technology

* Suitable ballasts (type: NaHJ...PZT) are available on request

For HS lamps 600 to 1000 W/400 V and HI lamps 1000 W/400 V

Type	Ref. No.	Voltage AC 50–60 Hz V	Number of ignition pulses per mains period	Ignition voltage kV	Load capacity pF	Programmed switch-off time sec./Hz	Casing d (Ø) mm	a mm	b mm	c mm	Weight g
PZ 1000/400 V A5	142783*	380–420	≥ 1	4–5	20–800	300/50	40	80	—	—	155

* Suitable ballasts (type: NaHJ...PZT) are available on request

Pulse Ignitors for HS Lamps 50 to 1000 W

Standard version

For standard high pressure sodium lamps (HS)

Max. permitted casing temperature: 95 °C

Screw terminals: 0.5–1.5 mm²

Fastening: male nipple with pre-assembled washer and nut

For luminaires of protection class I

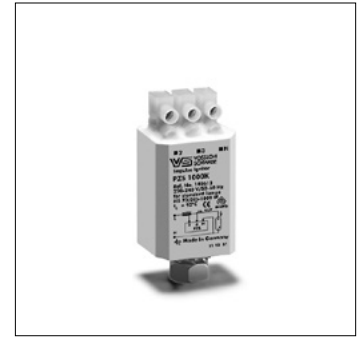
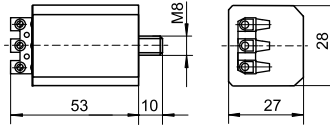

Type	Ref. No.	Voltage AC 50–60 Hz V	Number of ignition pulses per mains period	Ignition voltage kV	Load capacity pF	Programmed switch-off time sec.	Casing				Weight g
							d (∅) mm	a mm	b mm	c mm	
Plastic casing (PC)											
PZS 1000 K	140613	220–240	approx. 1/sec.	approx. 4	20–4000	—	—	50	28	27	50

Not suitable for HS lamps types Plus, Super, XL, HO

Suitable ballasts (type: NaH...P) are available on request

Pulse Ignitors for HI Lamps 250 to 2000 W, Ignition Voltage up to 1 kV

Standard version

For metal halide lamps (HI)

with ignition voltage of 0.9 kV

Max. permitted casing temperature: 95 °C

Screw terminals: 0.5–2.5 mm²

Fastening: male nipple with pre-assembled washer and nut

For luminaires of protection class I

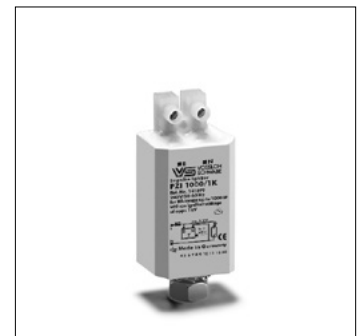
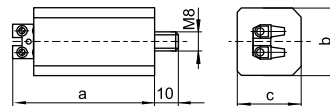

Type	Ref. No.	Voltage AC 50–60 Hz V	Number of ignition pulses per mains period	Ignition voltage kV	Load capacity pF	Programmed switch-off time sec.	Casing			Weight g
							a mm	b mm	c mm	
Plastic casing (PC)										
PZI 1000/1 K	140617	220–240	≥ 1	0.7–0.9	max. 10000	—	57	28	27	50

Electronic Power Switches for HS Lamps up to 600 W and HM Lamps up to 700 W



For high pressure sodium lamps (HS) and mercury vapour lamps (HM)
 For power reduction by using ballasts with multiple voltage tapping and superimposed ignitors
 PR 12 K LC and PR 12 K D are also suitable for power switching of LED drivers and electronic ballasts.
 Casing: PC
 Max. permitted casing temperature t_c : 80 °C
 Screw terminals: 0.75–2.5 mm²
 Fastening: male nipple with pre-assembled washer and nut
 For luminaires of protection class I and II
 Circuit diagrams for power reduction see pages 62–64.

PU 12 K/PR 12 KD/PR 12 K LC

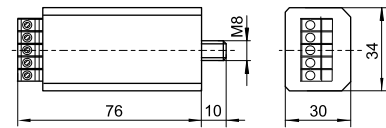

PU 120 K

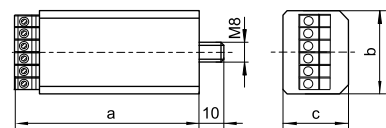

PU 121 K

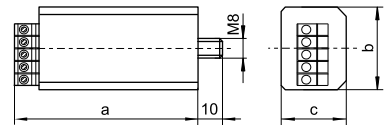

Advantages of PR 12 K LC

- intelligent, auto-adaptive concept
- eliminates the time-consuming task of continually adjusting the times of power-reduced operation to suit constantly changing day-night cycles
- removes the need for making adjustments due to daylight-saving times
- easy programming via dial
- no additional control line necessary
- optimal suitable for the supplementary integration into existing luminaires
- suitable for luminaires of protection class I and II

Type	Ref. No.	Voltage AC V, Hz	Max. contact current		Inherent heating K	Integrated delay switching	Control phase for power reduction (circuitry logic)	Casing			Weight g
			A/λ	A/λ				a mm	b mm	c mm	
Power reduction with control phase											
PU 12 K	140621	230, 50 / 220, 60	8/0.5	12/1	< 25	—	disconnect or connect	74	34	27	100
PU 120 K	140622*	230, 50 / 220, 60	8/0.5	12/1	< 10	327 sec.	disconnect	74	34	27	100
PU 121 K	140623*	230, 50 / 220, 60	8/0.5	12/1	< 25	327 sec.	connect	74	34	27	100
Power reduction without control phase											
PR 12 K LC****	142170**	220–230 ±10%, 50 220 ±10%, 60	8/0.5	12/1	< 12	selectable	without control phase	76	34	31	100
PR 12 K D****	142150***	220–230 ±10%, 50 220 ±10%, 60	8/0.5	12/1	< 12	selectable	without control phase	76	34	31	100

* For full-load lamp start

** Time of power-reduced operation selectable, starting point of switching-time changes automatically to suit constantly changing day-night cycles

*** Power reduction after a constant switching-time (delay switching); switching-time selectable: 3 | 3.5 | 4 | 4.5 | 5 | 5.5 | 6 hrs at 50 Hz

**** 120–240 V ±10% on request

Switch Units for Electronic Operating Devices with 1-10 V Interface

Vossloh-Schwabe's switch units are designed to enable one-step power reduction of lamps (FL, CFL, LED, HS, HI and C-HI) with the help of the respective electronic ballast or converter.

To this end, the switch unit utilises the 1-10 V interface of the control gear unit. The switch unit is mainly intended for outdoor luminaires in systems with or without a control phase.

Shape: 56x28x27 mm

Casing: PC

Screw terminals: 0.75-2.5 mm²

Max. permissible casing temperature t_c : 80 °C

Min. permissible ambient temperature t_a : -30 °C

Fastening: plastic male nipple with pre-assembled washer and nut

Power reduction SU 1-10 V K for lighting systems featuring an LST control phase

The switch unit employs a positive switching to reduce power, i.e. power is reduced when the control phase is switched off (LST = 0 V).

The 1-10 V interface of the electronic ballast is addressed at the moment that power reduction is effected.

Power reduction PR 1-10 V K LC for lighting systems without a control phase

This switch unit can be used to effect power reduction in lighting systems that do not feature a control phase.

The 1-10 V interface is addressed on the basis of the fundamental operating principle used by Vossloh-Schwabe's PR 12 K LC power switch (details of which can be made available on request). This power switch is capable of determining the starting time of reduced-power operation over the measured operating time of a lighting system. As a result, it is no longer necessary to spend valuable time modifying the power-reduction unit to suit the continually changing day-night cycle; changing the clocks in line with daylight saving measures in the summer and winter is equally unnecessary. The 1-10 V interface of the electronic ballast is addressed as soon as the system is switched to reduced power.

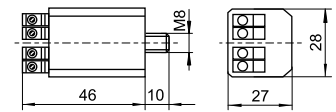

Circuit diagram SU 1-10 V K

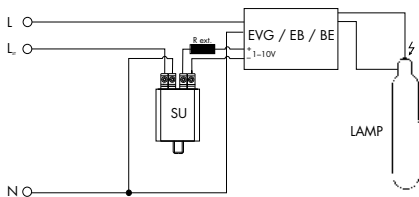

Circuit diagram PR 1-10 V K LC

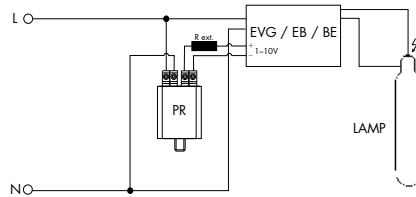

Type	Ref. No.	Control voltage LST V, 50/60 Hz	Externally (on site) connected resistor (R _{ext.}) kΩ (min. 0.1 W)	Self-heating K	Weight g
For lighting systems with control phase					
SU 1-10 V K	149992	220-240 V ±10%	1-70	< 10	50
For lighting systems without control phase					
PR 1-10 V K LC	149993	—	1-70	< 10	50

Start-up Switches for HS and HI Lamps 35 to 1000 W and HM Lamps 50 to 700 W

To bridge a phase of darkness during the starting-up period of high-pressure discharge lamps and also after a brief interruption of the power supply until the high-pressure discharge lamps are restarted

For mercury vapour lamps (HM), high-pressure sodium lamps (HS), metal halide lamps (HI) and ceramic discharge lamps (C-HI)
For HS, HI and C-HI lamps only if used together with a superimposed ignitor

Nominal voltage/frequency:

220–230 V ± 10%/50–60 Hz

240 V ± 10%/50 Hz

Max. permitted casing temperature t_c : 85 °C

Screw terminals: 0.75–2.5 mm²

Fastening: male nipple with pre-assembled washer and nut

Max. wattage of incandescent lamp: 1000 W

Automatic switch-off at 60% of the discharge lamp's luminous flux

During the ignition and start-up period, the start-up switch activates an incandescent lamp to provide a basic level of lighting. After a brief interruption in the supply voltage during the re-ignition of the discharge lamp, the integrated control electronics also bridges the phase of darkness by switching on the auxiliary lighting. The incandescent lamp is automatically switched off when the discharge lamp has achieved a sufficient luminous flux (approx. 60%).

Circuit for HM lamps

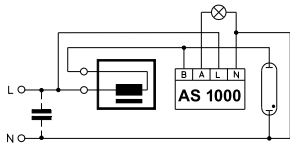

AS 1000 K

Casing: PC

Weight: 100 g

Internal loss: < 0.8 W

Inherent heating: < 10 K

Type: AS 1000 K

Ref. No.: 140627

Circuit for HS and HI lamps

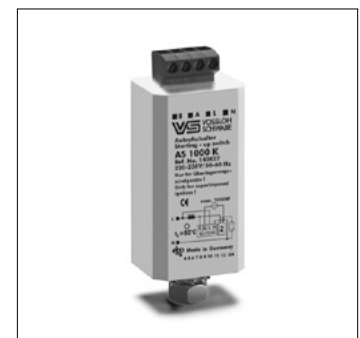
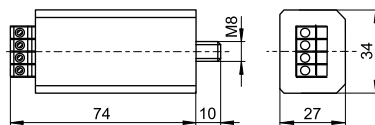
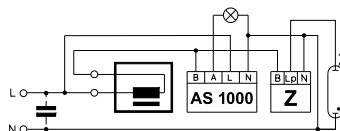

The time diagram shows some typical switching examples of a luminaire equipped with a high-pressure discharge lamp, incandescent lamp and start-up switch AS 1000 K.

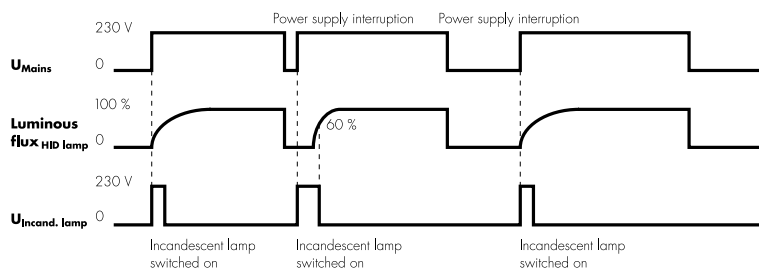

Electronic Discharge Units for Parallel Connected Capacitors 0.1 to 100 μF

On luminaires with parallel compensation and designed for plug connection to the mains supply, the plugs retain their charge for a relatively long time after disconnection from the power supply. The discharge resistors built into the compensation capacitor are designed for stationary lamps and when disconnected from the mains permit a voltage reduction to 50 V after 1 minute at the earliest.

According to European standard EN 60598-1, the compensation capacitor on mobile lamps must be discharged to 34 V within 1 second. Until now so-called discharge chokes built like conventional ballasts have been used for this purpose. These conventional discharge chokes are connected in parallel to the compensation capacitor and after disconnection from the power supply rapidly discharge the capacitor owing to their low ohmic resistance.

In their rated operating conditions, conventional discharge chokes exhibit a considerable inductive reactance which diminishes the effect of the compensation capacitor particularly if it has a low capacitance.

Furthermore, conventional discharge chokes cause considerable losses and feature high weight.

CE 50

All electronic, wear resistant switching element

Casing: aluminium

Nominal voltage: 34–264 V

Nominal frequency: 50–60 Hz

Internal loss: < 0.5 W

Inherent heating: < 6 K

Max. permitted casing temperature: 95 °C

Push-in terminals: 1 mm²

Fastening: male nipple with pre-assembled washer and nut

Weight: 40 g

Type: CE 50

Ref. No.: 140537

With the aid of the electronic discharge unit CE 50, it is possible to discharge a capacitor with a capacitance of up to 100 μF to 34 V within 1 second, i.e. within the time specified in EN 60598-1.

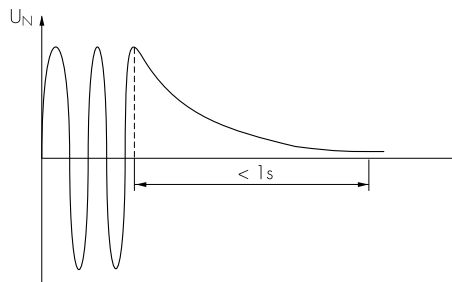

Thanks to its high reliability, low inherent losses, small dimensions and low weight, the CE 50 represents an inexpensive solution to the problem of capacitor discharge.

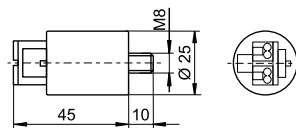
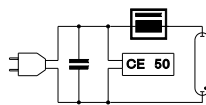

1

2

3

4

5

6

7

8

9

10

THERMOPLASTICS AND PORCELAIN



THE RIGHT MATERIAL MIX SPELLS A DECISIVE ADVANTAGE

The lampholders presented in this chapter are designed for high-pressure discharge lamps, for which high ignition voltages and high starting currents are characteristic. High temperatures can also occur with higher lamp outputs.

Vossloh-Schwabe therefore attaches great importance to ensuring casings, contacts and cables are made of high-grade materials.

Owing to the high ignition voltages, these lampholders are also governed by stricter requirements regarding creepage and air clearance distances.

When operating high-pressure discharge lamps with E27 and E40 Edison bases, care must be taken to ensure that the respective lampholders are approved for use with discharge lamps. Lampholders that are suitable in this respect are marked with "5 kV".

Lampholders with E26 and E39 bases and UL-approved wiring can be found under www.unvlt.com/products/legacy/lampholders.

E27 lampholders	42-44
E40 lampholders	44-46
GY9.5 lampholders	46
G12 lampholders	46-47
RX7s lampholders	47-49
K12x30s lampholders	49
K12s-7 support	49
Technical details for discharge lamps	50-119
General technical details	228-236
Glossary	237-239

E27 Lampholders

For discharge lamps with base E27

E27 lampholder, for cover caps (see p. 186–188)
 Profiled shape, external thread 40x2.5 IEC 60399
 Nominal rating: 4/250/5 kV
 Push-in twin terminals: 0.5–2.5 mm²
 Fixing holes for screws M3
 Rear fixing holes for self-tapping screws
 acc. to ISO 1481/7049-ST3.9-C/F
 Weight: 15/16.5 g, unit: 500 pcs.
 Type: 64719

Ref. No.: 505720 LCP, black, T270

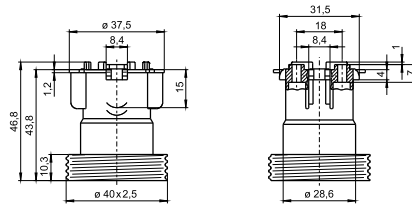

E27 lampholder, for cover caps (see p. 186–188)
 Profiled shape, plain
 Nominal rating: 4/250/5 kV
 Push-in twin terminals: 0.5–2.5 mm²
 Fixing holes for screws M3
 Rear fixing holes for self-tapping screws
 acc. to ISO 1481/7049-ST3.9-C/F
 Weight: 15 g, unit: 500 pcs.
 Type: 64770

Ref. No.: 505014 LCP, black, T270

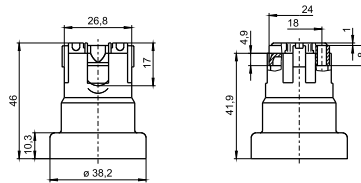

E27 lampholders
 Casing: porcelain, white, T210
 Nominal rating: 4/250/5 kV
 Screw terminals: 0.5–2.5 mm²
 Spring loaded central contact
 Oblong holes for screws M4
 Weight: 65/67.7 g, unit: 200 pcs.
 Type: 62600

Ref. No.: 102635

Type: 62601 with lamp safety catch

Ref. No.: 102637

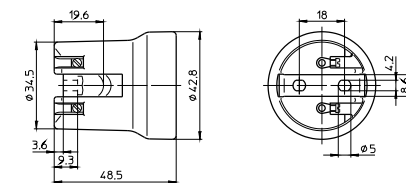

E27 lampholder
 Casing: porcelain, white, T210
 Nominal rating: 4/250/5 kV
 Screw terminals: 0.5–2.5 mm²
 Spring loaded central contact
 Threaded bushes for screws M3
 Weight: 69.3 g, unit: 200 pcs.
 Type: 62622

Ref. No.: 108416

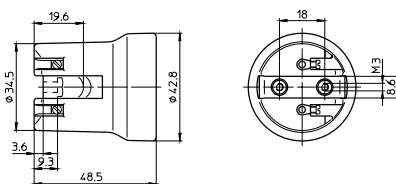

Lampholders for Discharge Lamps

E27 lampholders

Casing: porcelain, white, T210
 Nominal rating: 4/250/5 kV
 Screw terminals: 0.5–2.5 mm²
 Spring loaded central contact
 Oblong holes for screws M4, length max. 15 mm
 Weight: 106.8/103.9 g, unit: 100 pcs.
 Type: 62104

Ref. No.: 102615

Type: 62105 with lamp safety catch

Ref. No.: 102617

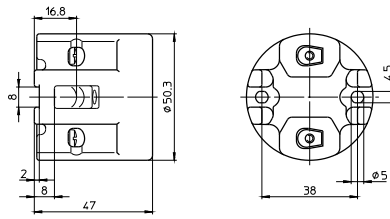

1

2

E27 lampholders

Casing: porcelain, white, T210
 Nominal rating: 4/250/5 kV
 Screw terminals: 0.5–2.5 mm²
 Spring loaded central contact
 Fixing bracket with slot for screws M5
 Weight: 113 g, unit: 100 pcs.
 Type: 62110

Ref. No.: 106585

Type: 62111 with lamp safety catch

Ref. No.: 109568

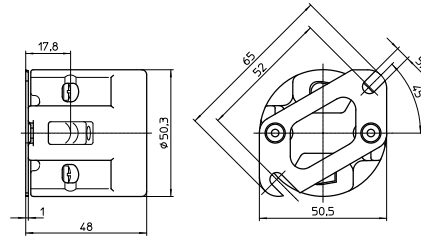

3

4

E27 lampholders

Casing: porcelain, white, T270
 Nominal rating: 4/250/5 kV
 Screw terminals: 0.5–2.5 mm²
 Spring loaded central contact
 Fixing oblong holes for screws M4
 Weight: 60.6 g, unit: 200 pcs.
 Type: 62050

Ref. No.: 102599

Type: 62010 with lamp safety catch (with spring)

Ref. No.: 102577

Type: 62009 with lamp safety catch (with crushing)

Ref. No.: 544605

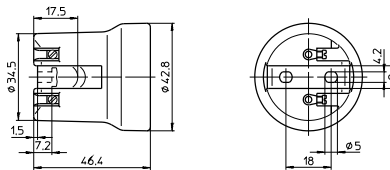

5

6

E27 lampholder

Casing: porcelain, white, T270
 Nominal rating: 4/250/5 kV
 Screw terminals: 0.5–2.5 mm²
 Spring loaded central contact
 Fastening bushes for screws M3
 Weight: 66.3 g, unit: 200 pcs.
 Type: 62015

Ref. No.: 102582

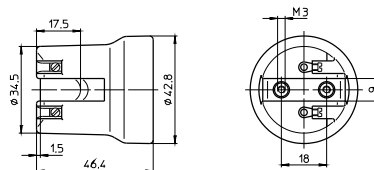

7

8

E27 lampholder, one-piece

Material: porcelain, white, T270
 Nominal rating: 4/250/5 kV
 Screw terminals: 0.5–2.5 mm²
 Spring loaded central contact
 Fixing oblong holes for screws M4
 Weight: 60.5 g, unit: 200 pcs.
 Type: 62070

Ref. No.: 543304

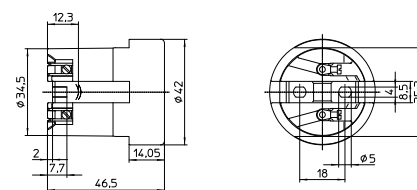

9

10

Lampholders for Discharge Lamps

E27 lampholder, for cover caps (see page 186–188)

Casing: porcelain, white, T270
 Nominal rating: 4/250/5 kV
 Screw terminals: 0.5–2.5 mm²
 Spring loaded central contact
 Fixing oblong holes for screws M4
 Weight: 66.5 g, unit: 150 pcs.
 Type: 62310

Ref. No.: 102624

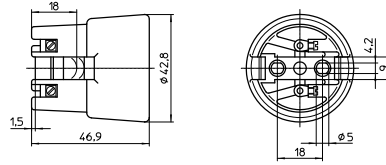

E27 lampholder

Casing: porcelain, white, T270
 Nominal rating: 4/250/5 kV
 Screw terminals: 0.5–2.5 mm²
 Spring loaded central contact
 Fixing oblong holes for screw M4
 Weight: 66.5 g, unit: 200 pcs.
 Type: 62370

Ref. No.: 543303

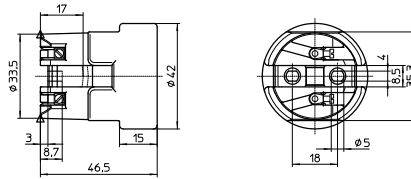

E40 Lampholders

For discharge lamps with base E40

Nominal rating: 18/500/5 kV
 Screw terminals: 1.5–4 mm²
 Spring loaded central contact

E40 lampholders

Casing: PPS, black, T240
 Oblong holes for screws M5
 Weight: 111.7/112.1 g, unit: 40 pcs.
 Type: 12600/12601

Ref. No.: 400913

Ref. No.: 400914 with lamp safety catch

With steel thread

Ref. No.: 533428

Ref. No.: 533429 with lamp safety catch

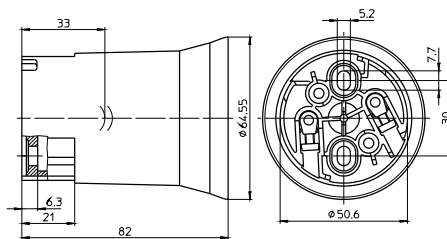

E40 lampholders

Casing: PPS, black, T240
 Fixing bracket with slots for screws M5
 Weight: 122.3/122.7 g, unit: 40 pcs.
 Type: 12610/12611

Ref. No.: 400915

Ref. No.: 400916 with lamp safety catch

With steel thread

Ref. No.: 533430

Ref. No.: 533431 with lamp safety catch

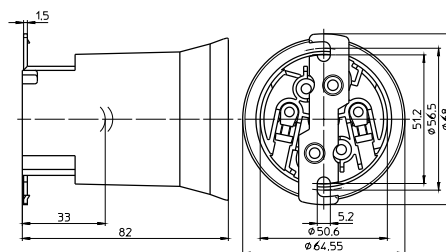

Lampholders for Discharge Lamps

E40 lampholders

Casing: PPS, black, T240

Fixing bracket with tapped fixing holes M5

Weight: 122.9/123.3 g, unit: 40 pcs.

Type: 12614/12612

Ref. No.: 400917

Ref. No.: 400918 with lamp safety catch

With steel thread

Ref. No.: 536220

Ref. No.: 533432 with lamp safety catch

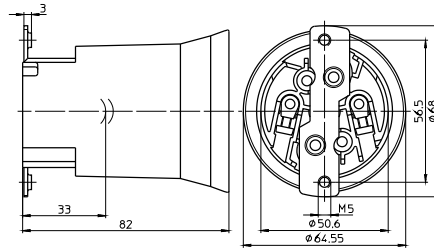

1

2

E40 lampholders

Casing: porcelain, white, T270

Oblong holes for screws M5

Weight: 224/229.3 g, unit: 48 pcs.

Type: 12800/12801

Ref. No.: 108208

Ref. No.: 107780 with lamp safety catch

With steel thread

Ref. No.: 532602

Ref. No.: 532603 with lamp safety catch

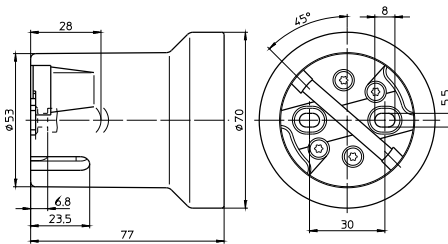

3

4

E40 lampholders

Casing: porcelain, white, T270

Fixing bracket with slots for screws M5

Weight: 252.3/243 g, unit: 48 pcs.

Type: 12810/12811

Ref. No.: 108374

Ref. No.: 108375 with lamp safety catch

With steel thread

Ref. No.: 532604

Ref. No.: 532605 with lamp safety catch

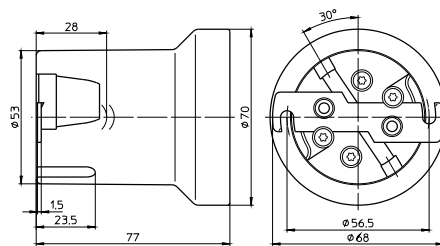

5

6

E40 lampholders

Casing: porcelain, white, T270

Fixing bracket with tapped fixing holes M5

With lamp safety catch

Weight: 252.8 g, unit: 48 pcs.

Type: 12812

Ref. No.: 108373

With steel thread

Ref. No.: 532606

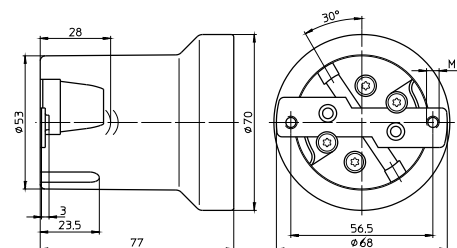

7

8

E40 lampholders

Only for lamps with base E40/E45

Casing: porcelain, white, T270

Oblong holes for screws M5

Weight: 206 g, unit: 50 pcs.

Type: 12900/12901

Ref. No.: 528252

Ref. No.: 528958 with lamp safety catch

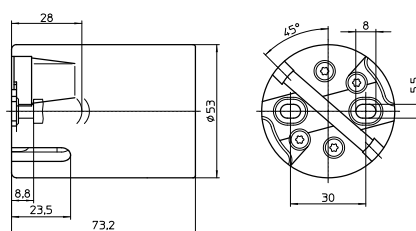

9

10

Lampholders for Discharge Lamps

E40 lampholders

Only for lamps with base E40/E45

Casing: porcelain, white, T270

Fixing bracket with slots for screws M5

Weight: 217 g, unit: 50 pcs.

Type: 12910/12911

Ref. No.: 528253

Ref. No.: 528254 with lamp safety catch

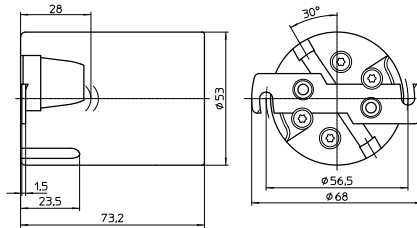

GY9.5 Lampholders

For discharge lamps with base GY9.5

GY9.5 lampholder

Casing: ceramic, cover plate: PPS, black

T240, nominal rating: 10/500/5 kV, contacts: Ni

Leads: Cu tinned, stranded conductors

5 kV: 1 mm², Si-insulation max. Ø 3.6 mm,

length: 300 mm and Cu tinned,

stranded conductors 0.75 mm², Si-insulation, length: 300 mm

Fixing holes for screws M3

Weight: 48 g, unit: 150 pcs.

Type: 37001

Ref. No.: 533663

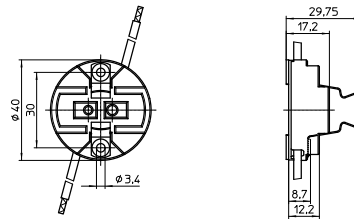

G12 Lampholders

For discharge lamps with base G12

G12 lampholders

Casing: ceramic, cover plate: LCP

T250, nominal rating: 5/500/5 kV

Contacts: CrNi

Push-in terminals for leads with

ferrule bare end of cores max. Ø 1.8 mm

Weight: 30.7 g, unit: 25 pcs.

Type: 42200/ 42210

Ref. No.: 535750 fixing holes Ø 4.2 mm

Ref. No.: 535751 threaded bushes M3

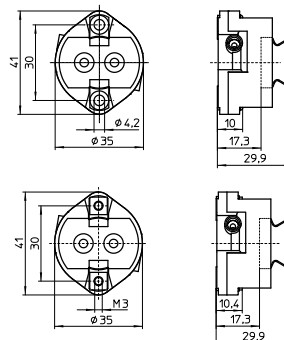

Lampholders for Discharge Lamps

G12 lampholders

Casing: ceramic

T250, nominal rating: 5/500/5 kV

Contacts: CrNi

Welded leads: Cu tinned, stranded conductors 1 mm²

Si-insulation, white, length: 300 mm

Weight: 43/52 g, unit: 25 pcs.

Type: 42222/42242

Ref. No.: 535755 cover plate: LCP

Ref. No.: 543643 cover plate: ceramic

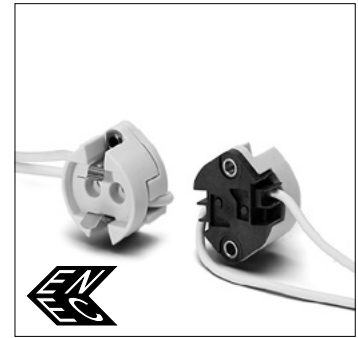
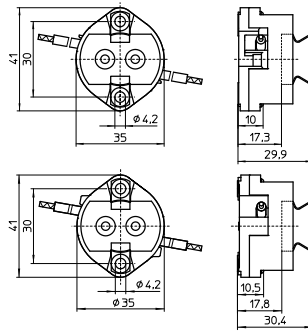

1

2

3

4

RX7s Lampholders

If the central hole on the bracket is used for fixing it has to be ensured by an additional support within the luminaire that the bracket cannot be deformed. If the lampholders are used for lamps with ignition voltage max. 20 kV the luminaire manufacturer is responsible for sufficient creepage distances and clearances.

Remark on lampholders type 323:

The luminaire design must ensure protection from electric shock as well as sufficient creepage distances and clearances from live parts on the back of lampholder.

Partly enclosed RX7s lampholder

Casing: ceramic, T350

Contact pin: Cu, silver bulb

Nominal rating: 4/500/5 kV

Lead: Cu tinned, stranded conductors 1 mm²,

Si-insulation max. Ø 3.6 mm, length: 200 mm

Fixing screw M4

Weight: 26.2 g, unit: 300 pcs.

Type: 32301

Ref. No.: 100913

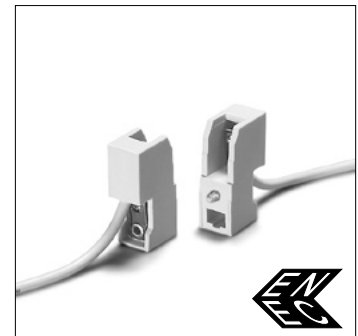
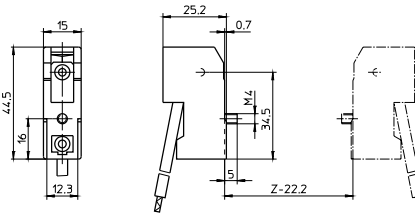

5

6

Partly enclosed RX7s lampholder

Casing: ceramic, T350

Contact pin: Cu, silver bulb

Nominal rating: 4/500/5 kV

Leads: Cu tinned, stranded conductors 1 mm²,

Si-insulation max. Ø 3.6 mm, length: 200 mm

Oblong holes for screws M4

Central hole for screw M4

Weight: 74.8 g, unit: 200 pcs.

Type: 32311 contact distance: 114.2 mm

Ref. No.: 100921

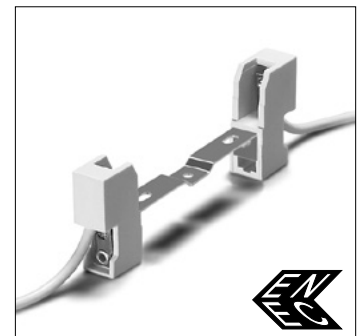
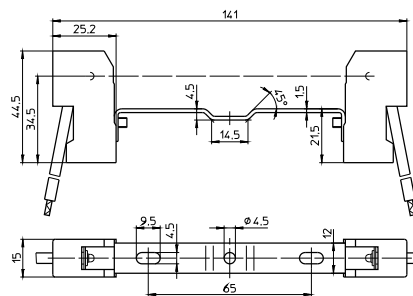

7

8

Partly enclosed RX7s lampholder

Casing: ceramic, T350

Contact pin: Cu, silver bulb

Nominal rating: 4/500/5 kV

Leads: Cu tinned, stranded conductors 1 mm²,

Si-insulation max. Ø 3.6 mm, length: 200 mm

Oblong holes for screws M4

Central tapped holes M4

Weight: 76 g, unit: 200 pcs.

Type: 32321 contact distance: 114.2 mm

Ref. No.: 100922

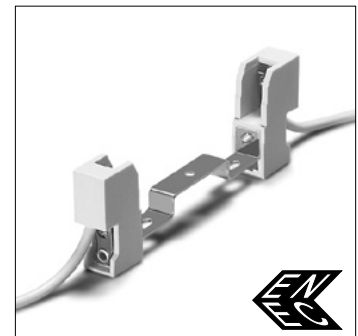
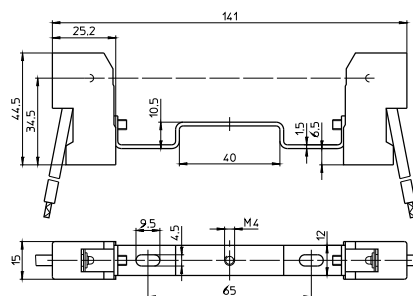

9

10

Lampholders for Discharge Lamps

Partly enclosed RX7s lampholder

Casing: ceramic, T350

Contact pin: Cu, silver bulb

Nominal rating: 4/500/5 kV

Leads: Cu tinned, stranded conductors 1 mm²,

Si-insulation max. Ø 3.6 mm, length: 200 mm

Oblong holes for screws M4

Central hole for screw M4

Weight: 74 g, unit: 200 pcs.

Type: 32341 contact distance: 114.2 mm

Ref. No.: 100932

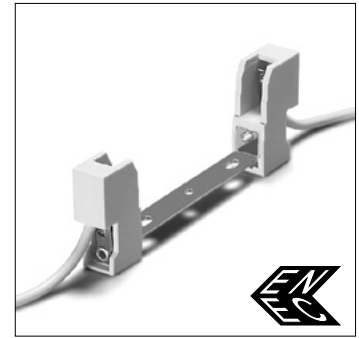
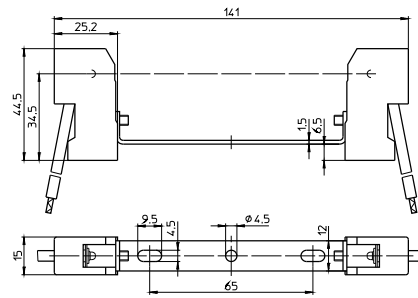

Partly enclosed RX7s lampholder

Casing: ceramic, T350

Contact pin: Cu, silver bulb

Nominal rating: 4/500/5 kV

Leads: Cu tinned, stranded conductors 1 mm²,

Si-insulation max. Ø 3.6 mm, length: 200 mm

Oblong holes for screws M4

Central hole for screw M5

Weight: 75.5 g, unit: 200 pcs.

Type: 32361 contact distance: 114.2 mm

Ref. No.: 100934

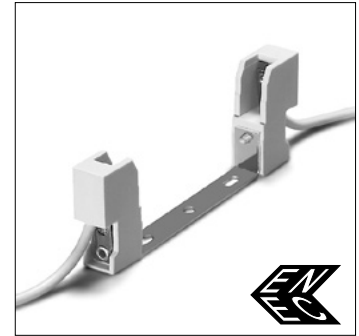
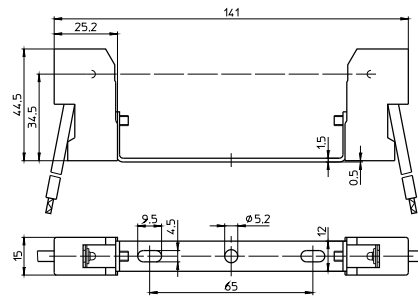

Partly enclosed RX7s lampholder

Casing: ceramic, T350

Contact pin: Cu, silver bulb

Nominal rating: 4/500/5 kV

Leads: Cu tinned, stranded conductors 1 mm²,

Si-insulation max. Ø 3.6 mm, length: 200 mm

Oblong holes for screws M4

Central hole for screw M5

Weight: 76.4 g, unit: 200 pcs.

Type: 32381 contact distance: 114.2 mm

Ref. No.: 100937

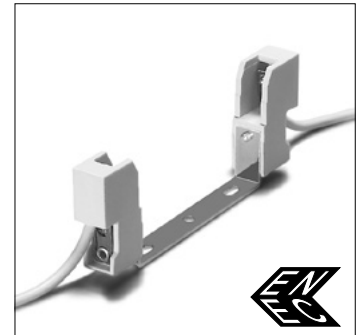
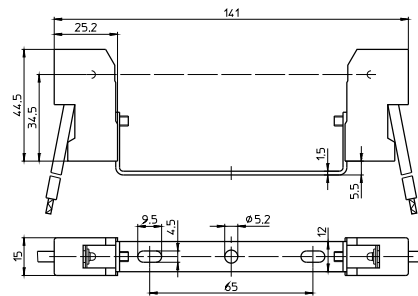

Partly enclosed RX7s lampholder

Casing: ceramic, T350

Contact pin: Cu, silver bulb

Nominal rating: 4/500/5 kV

Leads: Cu tinned, stranded conductors 1 mm²,

Si-insulation max. Ø 3.6 mm, length: 200 mm

Oblong holes for screws M4

Central tapped hole M4

Weight: 78.3 g, unit: 200 pcs.

Type: 32326 contact distance: 132 mm

Ref. No.: 100925

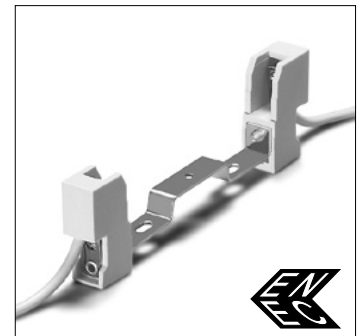
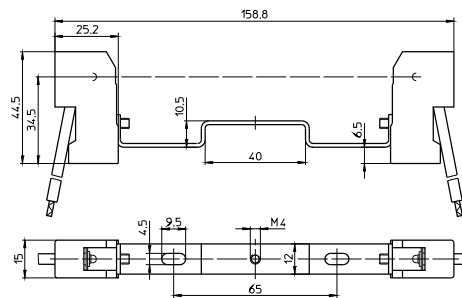

Partly enclosed RX7s lampholder

Casing: ceramic, T350

Contact pin: Cu, silver bulb

Nominal rating: 4/500/5 kV

Leads: Cu tinned, stranded conductors 1 mm²,

Si-insulation max. Ø 3.6 mm, length: 200 mm

Oblong holes for screws M4

Central hole for screw M5

Weight: 77.6 g, unit: 200 pcs.

Type: 32330 contact distance: 132 mm

Ref. No.: 100928

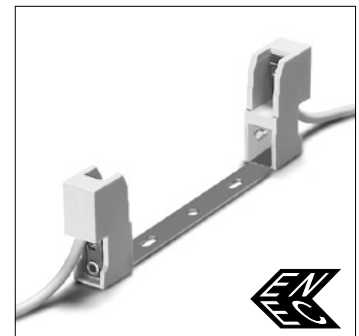
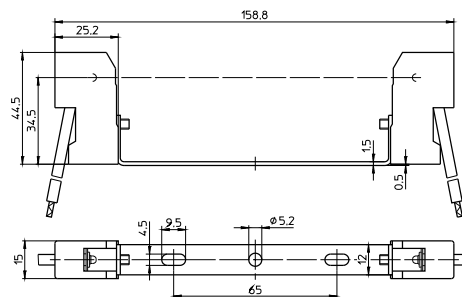

Lampholders for Discharge Lamps

Partly enclosed RX7s lampholder

Casing: ceramic, T350

Contact pin: Cu, silver bulb

Nominal rating: 4/500/5 kV

Leads: Cu tinned, stranded conductors 1 mm²,

Si-insulation max. Ø 3.6 mm, length: 200 mm

Oblong holes for screws M4

Central hole for screw M5

Weight: 75.7 g, unit: 200 pcs.

Type: 32336 contact distance: 132 mm

Ref. No.: 100931

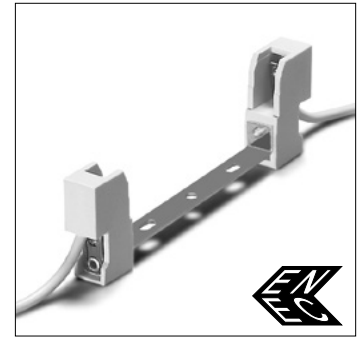
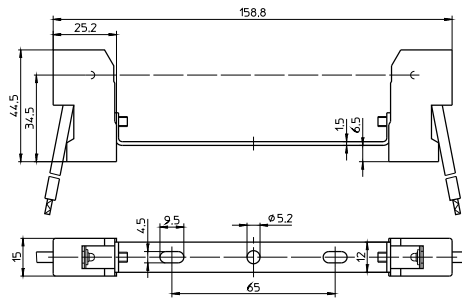

1

2

3

4

K12x30s Lampholders

For discharge lamps with base K12x30s

K12x30s lampholders

Suitable for luminaires of protection class II

Casing: LCP, black, T150

Nominal rating: 4/500/3 kV

Contacts: CuSn6, silver plated

Leads: Cu tinned, stranded conductors 1 mm²

Si-insulation, doubled insulated

Rear recess M4, wrench size 7

Rear and bottom fixing holes for screws M5

Weight: 75.9/61.5 g, unit: 100 pcs.

Type: 13010

Ref. No.: 532430 lead length: 705 mm

Ref. No.: 532431 lead length: 155 mm

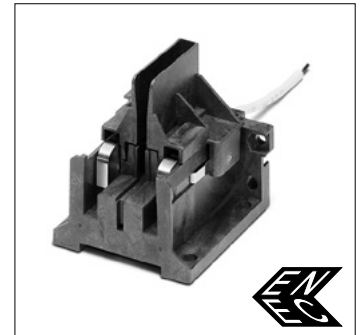
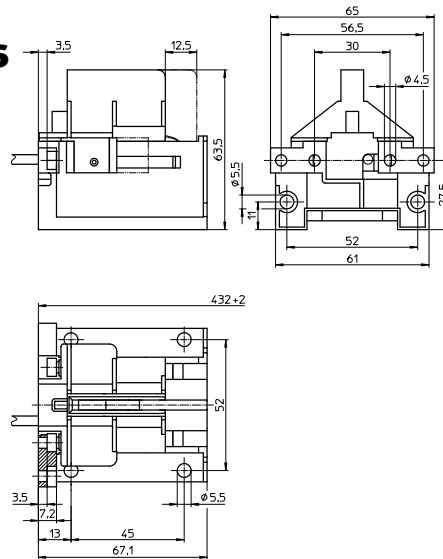

5

6

K12s-7 Support

For metal halide lamps 1000 and 2000 W

Type Osram HQI TS and Radium HRI TS

The luminaire design must ensure protection from electric shock as well as sufficient creepage and clearance distances.

K12s-7 support

Cable connection on cable lug for lead

0.75–2.5 mm²

Casing: ceramic, T300

Support: stainless steel, heat-resistant

Oblong holes for screws M5

Weight: 70 g, unit: 25 pcs.

Type: 21100

Ref. No.: 107677

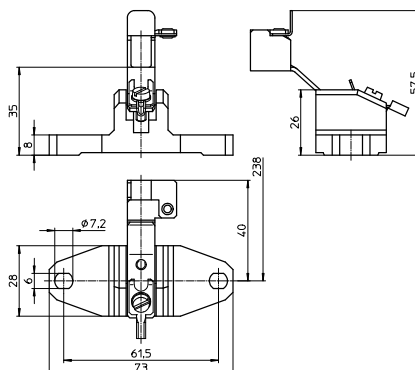

7

8

9

10

2

Components for Discharge Lamps

Electronic ballasts	51-56
Assembly instructions for mounting and installing	52-56
Circuit diagrams	56
Electromagnetic ballasts	56-64
Power reduction	57
Assembly instructions for mounting and installing	58-64
Circuit diagrams	62-64
Lampholders for high-pressure discharge lamps	65-66
Ignitors	66-71
Assembly instructions for mounting and installing	69-71
Power switches	72-74
Switch units	74-75
Energy efficiency classification	76
General technical details	228-236
Glossary	237-239

If the electrical current through a discharge lamp is increased, a discharge channel with very high luminous efficiency is created in the discharge chamber. Luminous flux and light output increase substantially. The internal pressure of the discharge chamber rises and attains between 1 and 10 bar – these are so-called high-pressure discharge lamps or simply discharge lamps. The light output and colour rendition of high-pressure lamps vary considerably depending on the lamp family.

Discharge lamps can only be operated with ballasts. Igniters are additionally required for sodium lamps and metal halide lamps. Furthermore, to compensate blind current when using magnetic ballasts, compensation capacitors must be fitted. The lampholders enable the lamp to be fixed in the luminaire and ensure simple exchange of lamps at the end of their service life.

As well as stabilising the lamp's operating point, ballasts also influence the lamp's output and luminous flux, the system's light output, the service life of the lamps as well as the colour temperature of the light.

The following chapters provide technical information regarding VS components for

- High-pressure sodium lamps (HS lamps)
- Metal halide lamps (HI lamps)
- Metal halide lamps with a ceramic discharge tube (C-HI lamps)
- Mercury vapour lamps (HM lamps)
- Low-pressure sodium lamps (LS lamps)

Electromagnetic or electronic ballasts can be used for high-pressure discharge lamps. Unlike with fluorescent lamps, lamp efficiency is not decisively altered by the use of electronic ballasts. In contrast, electronic ballasts lead to a reduction of the inherent losses and thus to an increase in system efficiency. In addition, electronic ballasts ensure gentle lamp operation, which increases the lamp's service life.

Independent electronic and electromagnetic ballasts have also been developed, which in the form of control gear units then provide special advantages during application.

Electronic Ballasts for HI and C-HI Lamps

Electronic ballasts are fitted with all the components required to operate discharge lamps. Furthermore, they safely shut down lamps at the end of their service life to prevent high temperatures from being generated within the luminaires that could influence the service life of the luminaires and components.

By adding a strain-relief module, VS electronic built-in ballasts turn into independent operating devices that can, for instance, be used as a power unit and can also be installed in intermediate ceilings in this form.

1

2

3

4

5

6

7

8

9

10

Assembly Instructions for Electronic Ballasts

Assembly instructions for mounting and installing electronic ballasts for high-pressure discharge lamps

Mandatory regulations

DIN VDE 0100	Erection of low voltage installations
EN 60598-1	Luminaires – part 1: general requirements and tests
EN 61347-1	Operating devices for lamps – part 1: general and safety requirements
EN 61347-2-12	Control gear for lamps; part 2-12: Particular requirements for d.c. or a.c. supplied electronic ballasts for discharge lamps (excluding fluorescent lamps)
EN 55015	Limits and methods of measurement of radio disturbance characteristics of electrical lighting and similar equipment
EN 61000-3-2	Electromagnetic Compatibility (EMC) – part 3: maximum values – main section part 2: maximum values for mains harmonics (device input current up to and including 16 A per conductor)
EN 61547	Installations for general lighting purposes – EMC immunity requirements

Descriptions of VS EBs for discharge lamps

The type designations for VS HID ballasts all follow the same pattern, as follows:

EHXc	70	.326
Electronic ballast for HID lamps	Wattage	Serial number

Mechanical mounting

Surface	Firm, flat surface required to ensure good heat transfer. Avoid mounting on protruding surfaces.
Mounting location	Electronic ballasts must be protected against moisture and heat. Installation in outdoor luminaires: water protection rate of > 4 (e.g. IP54 required).
Fastening	Using M4 screws in the designated holes
Heat transfer	If the ballast is destined for installation in a luminaire, sufficient heat transfer must be ensured between the electronic ballast and the luminaire casing. Electronic ballasts should be mounted with the greatest possible clearance to heat sources or lamps. During operation, the temperature measure at the ballast's t_c point must not exceed the specified maximum value.

Supplement for independent electronic ballasts

Mounting position	Any position using the mounting tabs
Clearance	Min. of 0.10 m from walls, ceilings and insulation Min. of 0.10 m from further electronic ballasts Min. of 0.25 m from sources of heat (lamp)
Surface	Solid; EB must not be allowed to sink into insulation materials

Technical specifications

Type	Operating voltage range AC: 220 V...240 V	Protective conductor mA	Mean service life*** hrs.	Power factor λ	Temperature protection*	Possible no. of VS devices/automatic cutout type			
						B (10A)	B (16A)	C (10A)	C (16A)
Standard EB									
EHXc 35.325 (183033;183034)	$\pm 10\%$	≤ 0.5	32,000 (t_c 85 °C)	0.95	yes**	7	12	12	20
			40,000 (t_c 80 °C)						
			50,000 (t_c 75 °C)						
EHXc 35.325 (183035)	$\pm 10\%$	≤ 0.5	32,000 (t_c 80 °C)	0.95	yes	7	12	12	20
			40,000 (t_c 75 °C)						
			50,000 (t_c 70 °C)						
EHXc 70.326 (183036)	$\pm 10\%$	≤ 0.5	32,000 (t_c 80 °C)	0.95	yes**	7	12	12	20
			40,000 (t_c 75 °C)						
			50,000 (t_c 70 °C)						
EHXc 70.326 (183038)	$\pm 10\%$	≤ 0.5	26,000 (t_c 75 °C)	0.95	yes	7	12	12	20
			40,000 (t_c 65 °C)						
			50,000 (t_c 60 °C)						

* The devices are fitted with a temperature switch to protect against impermissible overheating.

Once the device has cooled down, it is switched on again. It may prove necessary to briefly dis- and then reconnect the device to the mains voltage.

** The temperature protection inside the luminaire must be checked when using devices without a cap.

*** To achieve the mean service life, the max. temperature ($t_{c,max}$) at the t_c point must not be exceeded; failure rate = 0.2% per 1000 hrs

Product features

Shutdown of defective lamps

In the event of a lamp failing to ignite or of a lamp with an increased operating voltage (end of the lamp's service life), the electronic ballast will switch off after a defined period of time (< 20 minutes). The ballast will also shut down if the lamp fails to attain its specified rated output. The ballast can be reset by disconnecting and then reconnecting the mains voltage. The ballast must always be disconnected from the mains prior to changing a lamp.

EOL Effect

In high-pressure discharge lamps, the EOL effect manifests itself in a change of the lamp's voltage. These changes can, for instance, occur due to unsealed parts of the burner or the rectifier effect. An automatic EOL cut-out prevents safety risks at the end of the service life of high-pressure discharge lamps. EOL tests are conducted to check the behaviour of electronic ballasts at the end of a lamp's service life. The EOL cut-out stops the lamp base overheating at the end of a lamp's service life.

Short-circuit resistance

The ballast outputs (to the lamp) are short-circuit-proof. Short-circuits between the lamp connection and the casing (earth conductor) will destroy the ballast.

Temperature protection

To prevent excess temperatures, some ballasts are fitted with temperature protection. A ballast will restart after it has cooled down. It might be necessary to briefly interrupt the supply voltage. The above table contains a list of temperature-protected devices.

Transient mains peak protection

Values are in compliance with EN 61547 (interference immunity).

1

2

3

4

5

6

7

8

9

10

Electrical installation

Wiring

- The wiring between the mains, electronic ballast and lamp must comply with the respective circuit diagram. Note: the luminaire casing (metal) must be connected to the earth conductor.
- The electronic ballast must be earthed using a toothed washer or similar (protection class I, compliance with RFI/BCI standards).
- To ensure compliance with RFI suppression limits, mains conductors should not be wired parallel to lamp conductors and maximum clearance should be ensured.
- After the installation of electronic ballasts, luminaires must be tested to ensure compliance with maximum values laid down in EN 55015.

It is permissible to connect the protective conductor of the ballast by attaching the ballast to metal conductors that are connected to the protective conductor. In doing so, care must be taken to ensure the protective conductor is contacted in accordance with EN 60598. If, however, a ballast is fitted with a connection terminal for a protective conductor without through-wiring and if this is to be used to connect the protective conductor, this connection terminal may only be used for the ballast itself.

Push-in terminals

The used terminals can be connected using rigid or flexible conductors with a section of 0.75–2.5 mm². The stripped conductor length is 10–11 mm for terminal grid 3.5 mm. Conductors must not be tin-plated.

Error current

Impulse-resistant leak-current protection must be installed. Distribute the luminaires to phases L1, L2 and L3; install tri-phase FI switches. If permissible, install FI switches with 30 mA leak current; connect no more than 15 luminaires as FI switches can be triggered at half the leak current value.

Tri-phase connection of luminaires with EB

- Prior to operating newly installed lighting systems: check the mains voltage is appropriate to the electronic ballast's mains voltage range (AC, DC).
- The N-type conductor must be properly connected to all luminaires or ballasts.
- Conductors can only be connected or disconnected if the ballast is disconnected from the mains. Attention: N-type conductors must never be disconnected individually or as the first element.
- Insulation resistance test: from L to PE (L and N must not be connected)
- The neutral conductor must be reconnected after completion of the test.

Electromagnetic Compatibility (EMC)

Vossloh-Schwabe's electronic ballast range was developed in accordance with valid EMC standards (interference, interference immunity and mains harmonics) and specially designed to ensure safe compliance with the limiting values. It is assumed that any remarks regarding conductor wiring and conductor length in the instructions for installing electronic ballasts in luminaires or for independent ballasts will be observed.

Compensation

Luminaires with electronic ballasts do not need compensation (power factor ≥ 0.95).

Selection of automatic cut-outs

Dimensioning automatic cut-outs

High transient currents occur when an EB is switched on because the capacitors have to load. Lamp ignition occurs almost simultaneously. This also causes a simultaneous high demand for power. These high currents when the system is switched on put a strain on the automatic conductor cut-outs, which must be selected and dimensioned to suit.

Release reaction

The release reaction of the automatic conductor cut-outs comply with VDE 0641, part 11, for B, C characteristics.

No. of electronic ballasts (see table on page 53)

The maximum number of VS ballasts applies to cases where the devices are switched on simultaneously. Specifications apply to single-pole fuses. The number of permissible ballasts must be reduced by 20% for multi-pole fuses. The considered circuit impedance equals 400 mΩ (approx. 20 m [2.5 mm²] of conductor from the power supply to the distributor and a further 15 m to the luminaire). Doubling circuit impedance to 800 mΩ increases the possible number of ballasts by 10%.

Additional information

Information on the installation of electronic ballasts for optimising EMC. To ensure good radio interference suppression and the greatest possible operating safety, the following points should be observed when installing electronic ballasts:

- Conductors between the EB and the lamp (HF conductors) must be kept short (reduction of electromagnetic interference).
- Mains and lamp conductors must be kept separate and if possible should not be laid in parallel to one another. The distance between HF and mains conductors should be as large as possible, ideally > 5 cm. (This prevents the induction of interference between the mains and lamp conductors.)
- The mains conductor within the luminaire must be kept short (to reduce the induction of interference).
- Devices must be properly earthed. EBs require secure contacts to the luminaire casing or must be earthed using a PE connection. This PE connection should be effected using an independent conductor to achieve better dissipation of the leak current. EMC improves at frequencies greater than 30 MHz.
- The mains conductor must not be laid too close to the EB or the lamp (this is especially important in the event of through-wiring).
- Mains and lamp conductors must not be crossed. Should this be impossible to avoid, conductors should be crossed at right angles to one another if at all possible.
- Should conductors be wired through metal parts, such conductors must always be additionally shielded (e.g. with an insulating sleeve or grommet).

Temperature

Reference point temperature t_c

The safe operation of electronic ballasts is dependent on the maximum permissible temperature not being exceeded at the measuring point. Vossloh-Schwabe has determined a casing temperature measuring point – $t_{c \max}$ – on all EB casings. To avoid shortening the service life or diminishing operating safety, the stipulated maximum temperature must not be exceeded at this t_c point. This point is determined by testing the converter during normal, IEC-standardised operation at the specified ambient temperature (t_a), which is also indicated on the type plate. As both the design-related ambient temperature and the ballast's inherent heat, as determined by the installed load, are subject to great variation, the casing temperature should be tested at the t_c point under real installation conditions.

Ambient temperature t_a

The ambient temperature – as specified on every EB – denotes the permissible temperature range within the luminaire.

Reliability and service life

If the max. temperature at the t_c reference point (as specified on the type plate and the technical documentation of the ballast) is not exceeded, the defined service life can be expected to be achieved, assuming a switching cycle of 165 minutes on and 15 minutes off. See table on page 53 for service life details.

1

2

3

4

5

6

7

8

9

10

Circuit diagrams for metal halide lamps (HI) and high-pressure sodium lamps (HS) with electronic ballasts (EB)

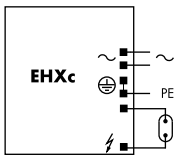

EHXc 35.325, EHXc 70.326

Electromagnetic Ballasts for Discharge Lamps

Electromagnetic ballasts for HI and HS Lamps

As the lamp manufacturer's reference values regarding lamp current and voltage are generally identical for metal halide (HI) and high-pressure sodium lamps (HS) of the same lamp wattage and the impedance values required for the ballast are also identical, the same ballasts can frequently be used for both lamp types. It should be remembered that HI lamps react sensitively to impedance deviations from the rated value with appreciable colour changes. Vossloh-Schwabe ballasts therefore comply with the lamp's narrower tolerances. Moreover, ballasts remain below the maximum peak DC value for HI lamps. This value is not specified for HS lamps; instead, the maximum stated start-up current must not be exceeded.

In order to keep the temperature of the luminaires and the electrical values of the lamps within tolerable limits, the impedance of the ballasts must remain constant over the entire service life. A so-called service life test (test of thermal durability) provides proof of this requirement having been met.

HI and HS lamps constitute a special case in terms of thermal testing. In rare cases, a safety risk can occur at the end of the service life of lamps fitted with external bulbs. The safety risk is caused by the so-called lamp rectifier effect, which can lead to overheating of ballasts, ignitors, lampholders and conductors and can therefore destroy the luminaire. Against this background, the luminaire standard EN 60598-1 "luminaires; part 1: general requirements and tests" has been supplemented by tests concerning this safety risk. As a result, since 1 September 2002, it has been illegal to market luminaires that do not comply with the new regulations. This means luminaires need to be fitted with thermal protection that prevents a luminaire from overheating in the event of this malfunction.

In this respect, it is recommended to use VS ballasts with temperature switches that have already been tested using this circuit.

Electromagnetic ballasts for HM lamps

Even in the event of major mains fluctuations (92–106% of the rated voltage), the ballast must not fall short of the no-load voltage specified by the lamp manufacturer nor exceed a fixed short-circuit current. The start-up current must be high enough to ensure that at least 90% of the lamp's operating voltage is achieved within 15 minutes.

Test circuit for thermally protected ballasts

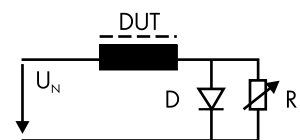

- DUT Device under Test
- D Diode, 100A, 600V
- R Resistor, 0...200 (1/2 lamp output)
- U_N 110% of rated supply voltage

Power reduction with HS and HM lamps

The lamp wattage can be reduced by operating the ballast at a higher impedance value, higher than the rated value. The lamp manufacturer's specifications must be observed in doing so to avoid shortening the lamp's service life. The lamps should be started at the ballast's rated impedance and only switched down to reduced operation after a period of at least five minutes.

The impedance value can be altered by using an additional ballast (high-effort option) or by using a switch-able ballast (low-cost option). These ballast models can be switched using either a modern, time-controlled electronic power reduction switch, which is equipped with an additional control conductor (230 V), or a power reduction switch with a constant incentive rate setting (no control conductor).

The construction of power reduction switches with control conductors differs according to the selected increase in impedance.

Start-up switches

As high-pressure lamps operate with a start-up phase, the lamp's full luminous flux will only be reached after completion of this start-up period. In the event of disconnection from the mains, this start-up phase is dependent on the lamp's temperature. If an additional source of light is desired or required for this start-up period for safety-relevant applications, it is possible to switch on an auxiliary lamp with the help of a start-up switch.

- AS 1000 K for superimposed ignition systems. This switch monitors the lamp's operating voltage. If this is below a defined value (approx. 60% of the lamp's luminous flux), an auxiliary lamp is switched on.

Lamp family	Typical start-up time	Typical restart time (mains interruption at lamp operating temperature)
HS	3 min.	5 min.
HI / C-HI	3 min.	10 min.
HM	4–5 min.	4–5 min.
LS	10 min.	5 min.

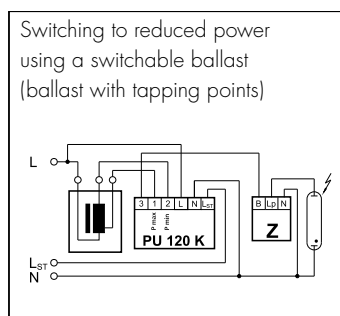
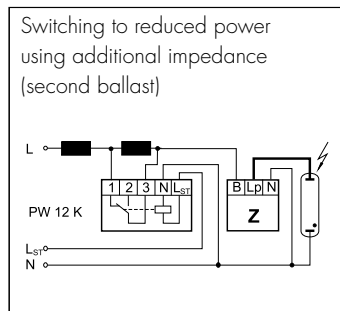

1

2

3

4

5

6

7

8

9

10

Assembly Instructions for Electromagnetic Ballasts

For mounting and installing electromagnetic ballasts for high-pressure discharge lamps

Mandatory regulations

DIN VDE 0100	Erection of low voltage installations
EN 60598-1	Luminaires – part 1: general requirements and tests
EN 61347-1	Operating devices for lamps – part 1: general and safety requirements
EN 61347-2-9	Operating devices for lamps; part 2-9: special requirements for ballasts for discharge lamps (except fluorescent lamps)
EN 60923	Ballasts for discharge lamps – performance requirements
EN 55015	Maximum values and methods of measurement for RFI suppression in electrical lighting installations and similar electrical appliances
EN 61000-3-2	Electromagnetic Compatibility (EMC) – part 3: maximum values – main section part 2: maximum values for mains harmonics (device input current up to and including 16 A per conductor)
EN 61547	Installations for general lighting purposes – EMC immunity requirements

Technical specifications

Operating voltage range	The ballasts can be operated at the specified mains voltage within a tolerance range of $\pm 10\%$ for HS/HI and HM lamps and $\pm 3\%$ for C-HI lamps.
Leak current	≤ 0.1 mA
Compensation/power factor	Inductive ballasts: $\lambda \leq 0.5$ Parallel-compensated ballasts: $\lambda \geq 0.85$

Mechanical mounting

Mounting position	Any
Mounting location	Ballasts are designed for installation in luminaires or comparable devices. Independent ballasts do not need to be installed in a casing.
Fastening	Preferably using M4 to M6 screws, depending on the size of the ballast. Encapsulated ballasts may only be used with flat-headed screws (M5), underlaid with a washer (DIN 9021). (Tightening torque ≈ 2 Nm)

Temperature The winding temperature t_w must be checked during operation and must not exceed the specified maximum value. It must be tested by using the standardised method of measuring resistance. The Δt marking on the type plate is a measure of the ballast's inherent heating and thus of its power loss. The lower this value is the lower the power loss of the ballast. This value is determined using standardised measuring regulations and constitutes a benchmark for comparing ballasts of the same design for selection purposes.

Electromagnetic compatibility (EMC)

Interference Interference voltage measurements have to be taken at the connection terminals for luminaires with electromagnetic ballasts as these are systems that operate with lamp voltages of under 100 Hz. These low-frequency interference voltages are generally not critical with high-pressure discharge lamps with electromagnetic ballasts.

Interference immunity Thanks to the robust design and choice of materials, electromagnetic ballasts provide a high degree of interference immunity and are not impaired by normal mains power interference.

Mains Harmonics After every zero crossing of the lamp current, discharge lamps experience a re-ignition peak as the lamps go out for a brief (imperceptible) moment. These re-ignition peaks of discharge lamps generate mains harmonics that are smoothed by the ballast's impedance. VS electromagnetic ballasts all comply with the stipulated maximum values.

Selection of automatic cut-outs for VS electromagnetic ballasts

Dimensioning automatic cut-outs When a ballast is switched on, high transient current peaks occur due to parasite capacitances that can accumulate with the number of luminaires. These high system switch-on currents put a strain on the automatic conductor cut-outs. For this reason, only surge-current-proof automatic cut-outs should be used for lighting systems.

Release reaction The release reaction of the automatic conductor cut-outs comply with VDE 0641, part 11, for B and C characteristics.

No. of ballasts The following values are meant as guidelines only and may vary depending on the respective lighting system. The maximum number of VS ballasts applies to cases where the devices are switched on simultaneously. Specifications apply to singlepole fuses. The number of permissible ballasts must be reduced by 20% for multi-pole fuses. The considered circuit impedance equals 400 m Ω (approx. 20 m of [2.5 m²] conductor from the power supply to the distributor and a further 15 m to the luminaire). Doubling circuit impedance to 800 m Ω increases the possible number of ballasts by 10%. The values quoted in the following tables are guidelines and can be affected by system-specific factors.

1

2

3

4

5

6

7

8

9

10

Technical Details – Components for Discharge Lamps

Possible number of ballasts connected to automatic cut-outs with or without compensation

Lamp data		Cp μF	Max. number of ballasts connected to automatic cut-outs – without compensation / with compensation																			
W	V		C10		C13		C16		C20		C25		B10		B13		B16		B20		B25	
			without	with	without	with	without	with	without	with	without	with	without	with	without	with	without	with	without	with	without	with
Mercury vapour lamps (HM)																						
50	230	7	10	19	13	25	15	31	18	39	23	49	8	10	11	12	13	15	16	18	20	23
80	230	8	6	12	7	15	9	19	11	24	14	30	6	6	8	7	10	9	12	11	15	14
125	230	10	4	7	5	9	7	12	7	15	9	19	4	4	5	5	7	6	9	7	10	9
250	230	18	2	4	3	5	3	6	3	7	4	9	2	2	3	2	3	3	4	3	5	4
400	230	25	1	2	1	3	2	4	2	5	2	6	1	1	1	1	2	22	3	2	3	2
700	230	40	–	1	–	1	1	2	1	2	1	3	1	–	1	–	1	1	1	1	2	1
1000	230	60	–	1	–	1	–	1	1	2	1	2	–	–	–	–	1	–	1	1	1	1
Metal halide lamps (HI)																						
35	230	6	11	22	14	29	18	36	23	45	29	50	9	11	12	14	15	18	18	23	23	27
70	230	12	7	12	9	15	11	18	14	23	17	29	5	8	6	10	8	13	9	16	12	20
100	230	12	6	10	7	13	9	16	11	20	14	25	4	7	5	9	6	11	8	14	10	17
150	230	20	4	7	5	9	6	11	7	14	9	17	2	5	3	6	4	8	5	10	6	12
250	230	32	2	5	2	6	3	7	4	9	5	11	1	3	1	4	2	5	3	6	4	8
400	230	35	2	3	2	4	3	5	4	7	5	8	1	2	1	3	2	4	2	5	3	6
1000	230	85	–	1	–	1	1	1	1	3	1	3	–	–	–	–	–	1	1	1	1	2
2000	380	60	–	1	–	1	–	2	–	2	–	3	–	–	–	–	–	1	–	1	–	2
2000	380	37	–	–	–	–	–	1	–	1	–	2	–	–	–	–	–	–	–	1	–	1
3500	380	100	–	–	–	–	–	–	–	–	–	–	–	–	–	–	–	–	–	–	–	–
High pressure sodium vapour lamps (HS)																						
35	230	6	11	22	14	29	18	36	23	45	29	50	9	11	12	14	15	18	18	23	23	27
50	230	10	9	16	11	20	14	24	18	31	22	38	6	11	8	14	10	17	13	22	16	27
70	230	12	7	12	9	15	11	18	14	23	17	29	5	8	6	10	8	13	10	16	12	20
100	230	12	6	10	7	13	9	16	11	20	14	25	4	7	5	9	6	11	8	14	10	17
150	230	20	4	7	5	9	6	11	7	14	9	17	2	5	3	6	4	8	5	10	7	12
250	230	36	2	5	2	6	3	7	4	9	5	11	1	3	1	4	2	5	3	6	4	8
400	230	45	1	3	1	3	2	4	3	5	4	7	1	2	1	2	1	3	2	4	2	5
600	230	60	1	2	1	2	1	2	2	3	2	4	–	1	–	1	1	2	2	2	2	3
1000	230	100	1	1	1	1	1	1	1	2	2	3	–	–	–	–	–	1	1	1	1	2

Safety functions

The VS range includes ballasts with an integrated temperature switch that safely disconnects the lamp from the power supply if the lamp should develop the rectifier effect towards the end of its service life. The cut-out behaviour of the temperature switch is influenced by the luminaire construction. The luminaire manufacturer is responsible for checking the factory settings of the temperature switch in accordance with EN 60598-1 Section 12.5. VS can adjust the temperature switch to the appropriate cut-out temperature to suit requirements.

Reliability and service life

Provided the maximum winding temperature is not exceeded, the ballasts can be expected to yield a service life of 100,000 operating hours. Failure rate < 0.025%/1,000 hrs

Electrical installation

- Push-in terminals Terminals can be contacted with rigid conductors up to a maximum of 1.5 mm².
- Screw terminals
- Terminals can be contacted with rigid or flexible conductors with ferrules on bare end of core
 - Conductor cross-sections are determined by the terminals and can vary according to type 0.5–1.5 mm² / 0.75–2.5 mm² / 1.5–2.5 mm²
 - Stripped lead length: 8–9 mm
 - Conductors must not be tin-plated
 - Max. tightening torque 0.5 Nm
- Wiring The wiring between the power supply, ballast and lamp must be in accordance with the respective circuit diagram (see pages 62–64).
- Components High-pressure discharge lamps must only be fitted with components that are rated to withstand the respective ignition voltage.

1

2

3

4

5

6

7

8

9

10

Circuit diagrams for high-pressure sodium lamps (HS) and metal halide lamps (HI)

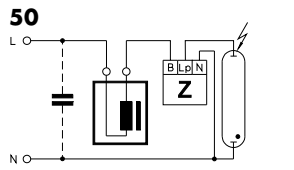

Superimposed ignition of HS and HI lamps

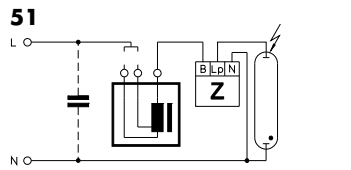

Superimposed ignition of HS and HI lamps (ballasts with two alternative voltage tapping points)

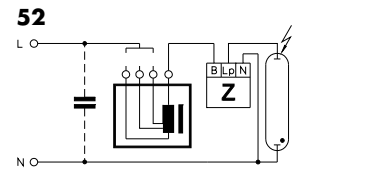

Superimposed ignition of HS and HI lamps (ballasts with three alternative voltage tapping points)

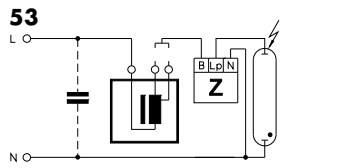

Superimposed ignition of HS and HI lamps (ballasts with two alternative power tapping points)

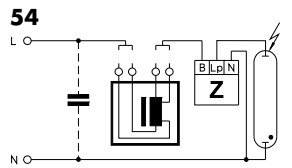

Superimposed ignition of HS and HI lamps (ballasts with two alternative voltage and power tapping points)

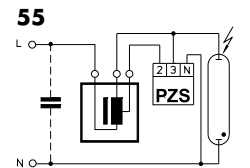

Pulse ignition of standard HS lamps

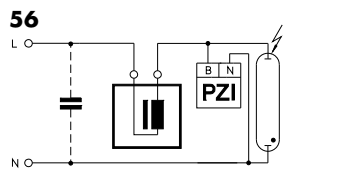

Pulse ignition of HI lamps, ignition voltage 0.9 kV

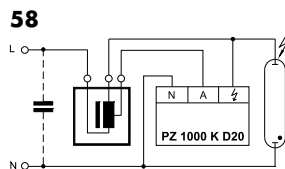

Pulse ignition for HS and HI lamps

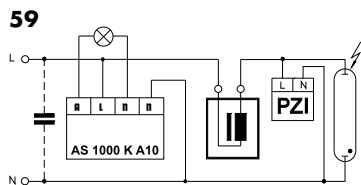

Start-up switch for HI lamps, ignition voltage 0.9 kV

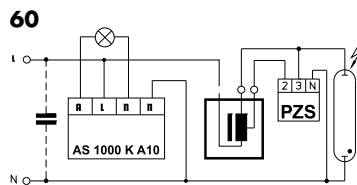

Start-up switch for standard HS lamps

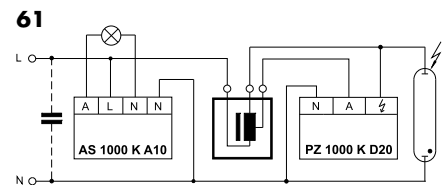

Start-up switch for HS and HI lamp

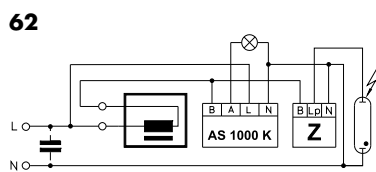

Start-up switch for HS and HI lamps

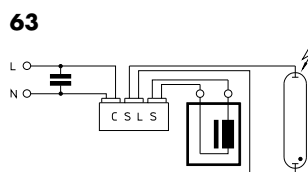

SDW-T lamps

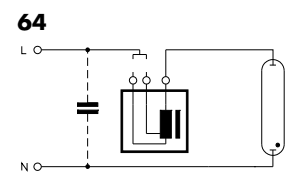

HS lamps with internal ignitor (ballasts with two alternative voltage tapping points)

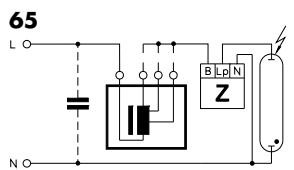

Superimposed ignition of HS and HI lamps with three alternative power tapping points

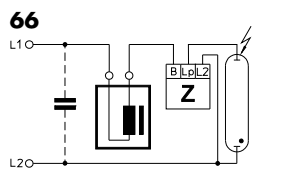

Superimposed ignition of HS and HI lamps with polyphase power systems

Circuit diagrams for mercury vapour lamps (HM)

67

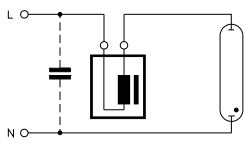

HM lamps

68

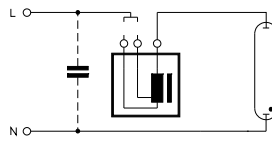

HM lamps (ballasts with two alternative voltage tapping points)

69

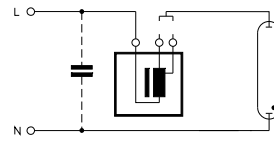

HM lamps (ballasts with two alternative power tapping points)

70

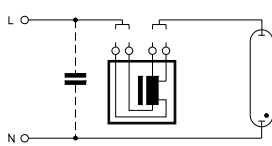

HM lamps (ballasts with two alternative voltage and power tapping points piece)

71

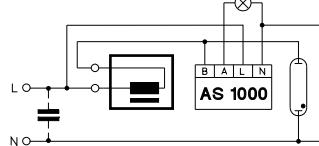

Start-up switch for HM lamps with auxiliary lamp

Power reduction of mercury vapour lamps (HM lamps)

L_{ST} connectable to L₁, L₂ and L₃

92

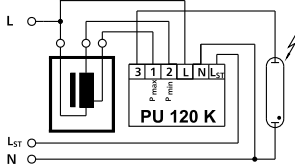

Disconnected control phase (L_{ST} = 0 V) with ballasts with two tapping points

93

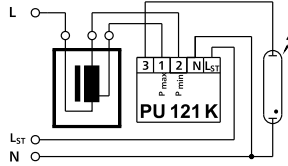

Connected control phase (L_{ST} = 230 V) with ballasts with two tapping points

94

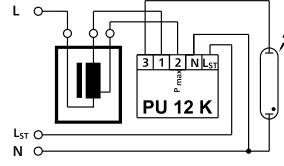

Disconnected control phase (L_{ST} = 0 V) with ballasts with two tapping points

95

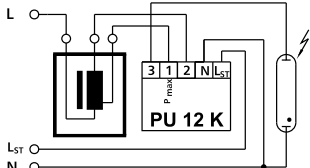

Connected control phase (L_{ST} = 230 V) with ballasts with two tapping points

96

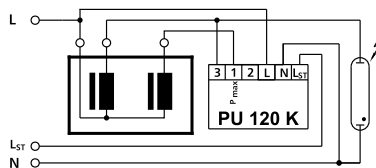

Disconnected control phase (L_{ST} = 0 V) with two ballasts connected in parallel

97

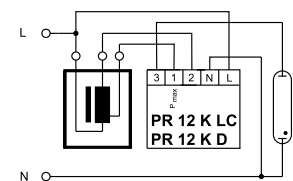

Electronic power reduction without control phase

98

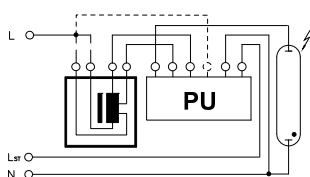

Ballasts with two tapping points and two voltage tapping points (L_{ST} = 0 V or L_{ST} > 0 V)

1

2

3

4

5

6

7

8

9

10

Power reduction of high-pressure sodium lamps (HS lamps) – superimposed ignition system

L_{ST} connectable to L1, L2 or L3

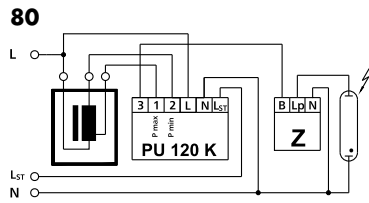

Disconnected control phase ($L_{ST} = 0\text{ V}$) with ballasts with two tapping point

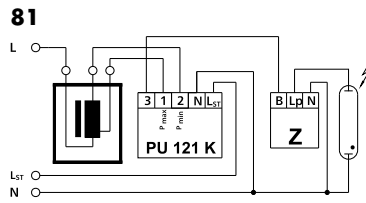

Connected control phase ($L_{ST} = 230\text{ V}$) with ballasts with two tapping points

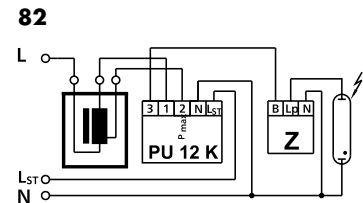

Disconnected control phase ($L_{ST} = 0\text{ V}$) with ballasts with two tapping points

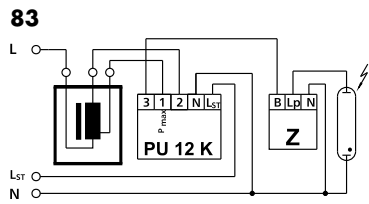

Connected control phase ($L_{ST} = 230\text{ V}$) with ballasts with two tapping points

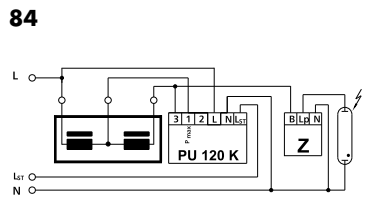

Disconnected control phase ($L_{ST} = 0\text{ V}$) with main ballast and additional inductance

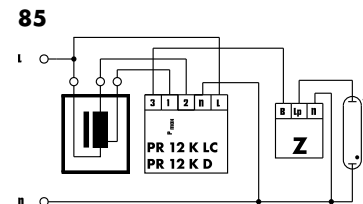

Electronic power reduction without control phase

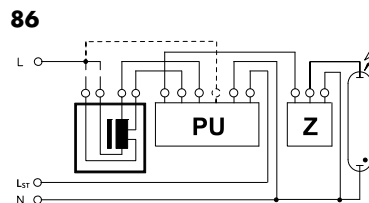

Ballast with two tapping points and two voltage tapping points ($L_{ST} = 0\text{ V}$ or $L_{ST} > 0\text{ V}$)

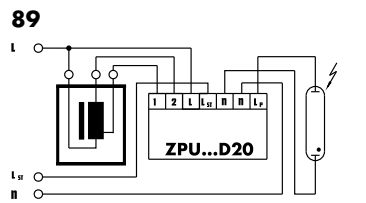

Disconnected control phase ($L_{ST} = 0\text{ V}$) with ballasts with two tapping points

Power switching of LED drivers and electronic ballasts

100

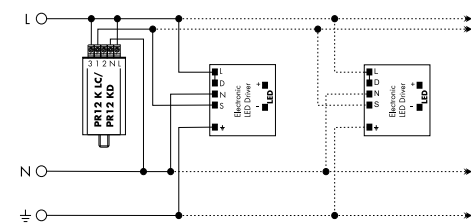

Lampholders for High-pressure Discharge Lamps

Metal halide and high-pressure sodium lamps feature extremely different bases, which include RX7s, Fc2, G8.5, GX8.5, GU8.5, GX10, G12, GX12, PG12, PGJ5, GU6.5, E27 and E40, depending on whether the lamp is single- or double-ended. All lampholders are subject to the same typical conditions found with discharge lamps: high ignition voltages and temperatures. The high start-up currents deserve particular attention in lampholder design. This is also reflected by the insulation materials, which are usually solid ceramics or heat-resistant plastic (e.g. PPS – polyphenylene sulphide). Depending on the lamp's requirements (voltage, current, temperature, etc.), silver, nickel and copper alloys with thick nickel coatings are used as conductors. The luminaire regulation EN 60598-1 (VDE 0711 part 1), defines the safety requirements with regard to ignition voltages in connection with creepage and air clearance distances. Special care must be taken to ensure that lampholders are approved for discharge lamps when using high-pressure lamps with E27 and E40 Edison bases. Lampholders that are suitable for this purpose are marked with a maximum value of "5 kV" and comply with the increased creepage and air clearance distances specified by the lampholder requirements in EN 60238 (VDE 0616 part 1). The lampholder regulations governing special lampholders, EN 60838-1 (VDE 0616 part 5), apply analogously to all other base systems. The high ignition voltage pulses also place special demands on the conductors. In practice, silicone-insulated conductors with an outer diameter of 3.6 mm have proved to be suitable for discharge lamps. Silicone-insulated conductors with a glass-silk lining with a diameter of 7 mm should be used for lamps with an instant hot restart (20 kV) function.

When connecting lampholders to push-in terminals of ballasts, the diameter of the conductor and the length of the stripped cables must be taken into account to ensure correct operation of the installed components. To this end, Vossloh-Schwabe can make additional versions available with compacted cable ends as further options.

When using compacted cable ends, the reduction of the cable diameter at the end of the cable must be taken into account, which means that the respective ballast push-in terminal has to be capable of taking the next-smaller cable diameter (see table with examples).

When using screw terminals to connect a ballast, it is recommended to use a ferrules on the bare end of core.

Cable cross-section mm ²	Push-in terminal range on the ballast when using compacted cable ends mm ²
0.75	≥ 0.5
1	≥ 0.75

Bases for the most commonly used HI and HS lamps

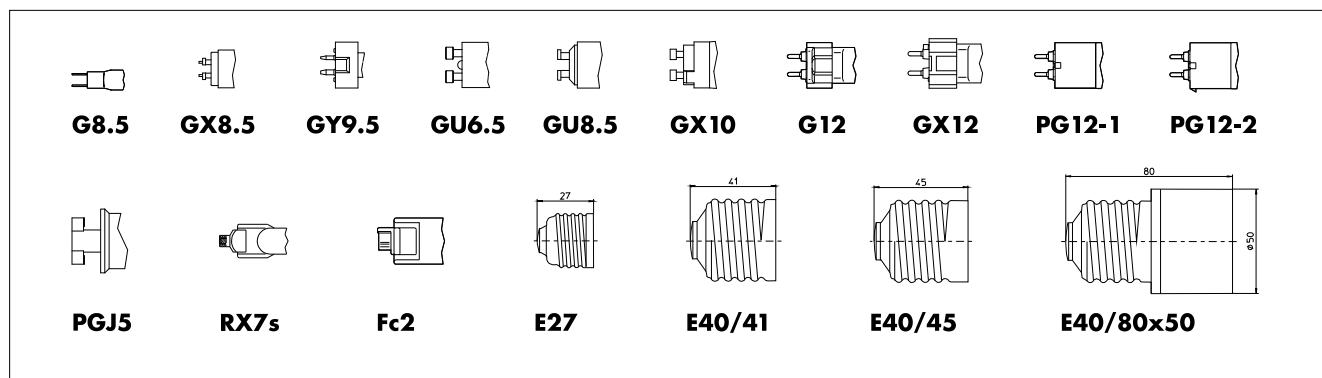

VS lampholders for the UL market and UL approved leads are available for all common lamp types.

Further information can be found at www.unvlt.com/products/legacy/lampholders.

Ferrule on bare end of core

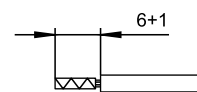

Compacted cable ends

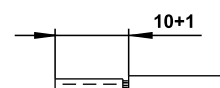

Bases for the most commonly used HM lamps

Edison bases are predominantly used for mercury vapour lamps (HM)

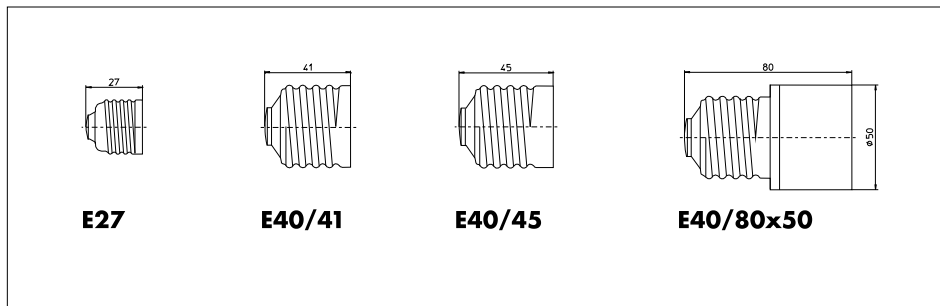

Ignitors

Ignition voltages for high-pressure sodium lamps (HS) and metal halide lamps (HI)

The ignition voltage of HS and HI lamps is determined by the respective lamp technology as well as the creepage and air clearance distances of the base-lampholder system. High-pressure sodium lamps of 35, 50 and 70 W with an E27 base are ignited with a voltage of between 1.8 and 2.3 kV. All other high-pressure lamps of the sodium and metal halide families require an ignition voltage of between 4 and 5 kV (except for special lamps and lamps with base PGJ5).

Superimposed ignitors

Superimposed ignitors work independently of ballasts and generate defined ignition pulses within the voltage ranges of 220–240 V $\pm 10\%$ and 380–415 V $\pm 10\%$. As the mains frequency only plays a minor role, these systems work equally well at 50 Hz and 60 Hz. In accordance with the lamp manufacturer's specifications, pulses or clusters of pulses of defined width and height are generated in every half wave. Although lamp current flows through superimposed ignitors, they only cause low losses in relation to the system's power consumption. The maximum ambient temperature can be calculated by subtracting the ignitor's self-heating, which is caused by the inherent losses, from the specified maximum casing temperature (t_c).

Superimposed ignitors should be mounted near the lampholder. The clearance needed between the ignitor and the lamp is determined by the respective maximum load capacitance, which is specified for each ignitor in the technical specifications. The capacitive load of the cable is dependent on its physical properties and wiring layout; this value usually ranges between 70 pF and 100 pF per metre. The casing temperature must not fall below $-30\text{ }^\circ\text{C}$ and must not exceed the maximum value specified on the device.

Pulse ignitors

Pulse ignitors use the winding of an inductive ballast to generate the pulse voltage needed to ignite high-pressure discharge lamps. For that reason, ballasts must be designed to withstand these high ignition voltages. In this respect, special attention is paid to the insulation as well as the creepage and air clearance distances. As pulse ignition systems generate high-energy pulses, they are also suitable in the event of longer conductor distances between ignitor and lamp. State-of-the-art ignitors feature electronic circuitry. Depending on their design and the technical requirements, the simplest solution is to connect pulse ignitors in parallel with the lamp. Further models make partial use of the winding of a ballast, which will either feature multiple tapping points for voltage selection or special tapping points for pulse operation.

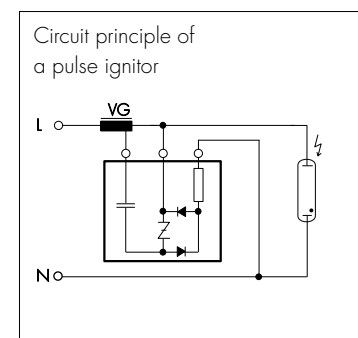
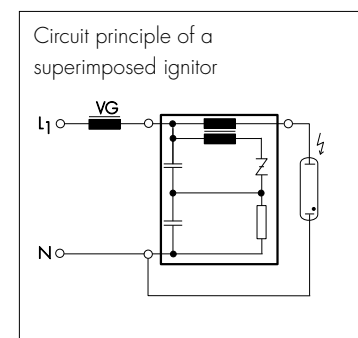

VS ignitors provide the following advantages:

- fully electronic construction
- compact design
- large nominal voltage range
- large output range
- low self-heating
- minimal power loss
- low noise
- long service life
- high electrical safety due to high-quality components (e.g. approved capacitors)
- highly heat-resistant (max. permissible casing temperature t_c : 105 °C for superimposed ignitors and 95 °C for pulse ignitors)
- highly fire-resistant potting compound (certified according to EN 60926 and UL 94-V0)
- environmentally compatible potting compound (waste key No. 57110)

Product range

Vossloh-Schwabe's product range covers superimposed and pulse ignitors in standard models and with automatic cut-outs. Superimposed ignitors with automatic cut-outs are available with various cut-out times and ignition voltage pulse mechanisms (A and D). In this respect, D-series ignitors featuring the intelligent pulse-pause mode (IPP) are the best solution in terms of ignition reliability and switching off defective lamps.

Electronic ignitors with integrated cut-outs capture data on ignition behaviour during the ignition process. These data, e.g. regarding ignition frequency or failure, serve to identify ageing lamps and to ensure the ignition process is reliably switched off after a defined period of time at the end of the lamp's service life or in the event of defective lamps. This reduces the negative consequences associated with defective lamps.

Superimposed and Pulse Ignitors with Automatic Cut-out

Ignitors with IPP technology and extended cut-out – D series

After connection to mains voltage, D series ignitors generate ignition voltage pulses that are controlled and if necessary switched off by the ignitor in accordance with the lamp's operating state, lamp recognition and the safe burning time. If the safe burning time is not attained after three consecutive ignition attempts, pulse generation will cease.

Appropriately programmed microprocessors enable these performance features of ignitors with IPP technology (Intelligent Pulse-Pause Mode) and extended cut-outs.

Z ... D20/

PZ ... D20 for HS, HI and C-HI lamps
programmed cut-out time: 1,216 seconds

Ignitors with IPP technology and extended cut-outs are available up to an output of 1,000 W.

1

2

3

4

5

6

7

8

9

10

Programmed cut-out function of VS ignitors

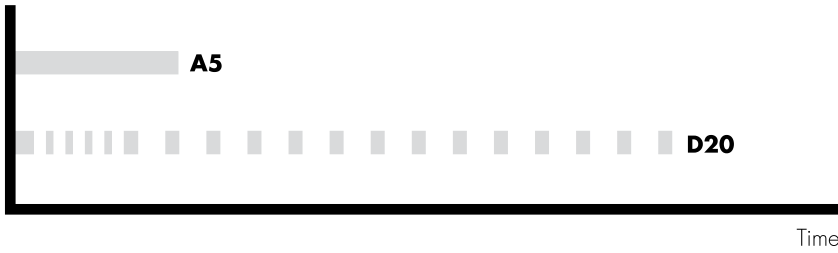

Ignitors with automatic cut-out – A series

After connection to mains voltage, A series ignitors supply a continuous stream of ignition voltage pulses until the lamp has ignited or the predefined cut-out time (sum of all ignition periods) has been reached if the lamp fails to ignite.

PZ ... A5 for HSI lamps
programmed cut-out time: ca. 300 seconds

Pulse ignition systems – overview of technical specifications

For HS, HI and C-HI lamps – PZ 1000 K D20

for high-pressure sodium lamps (HS) 50–1000 W,
metal halide lamps (HI) 35–1000 W and
for ceramic discharge tube lamps (C-HI) 35–400 W
Ignition voltage: 1.8–2.3 kV or 4–5 kV
No. of pulses: 2 per mains period
Load capacitance: 20–1000 pF
Ignitors with automatic cut-out and IPP technology
Suitable ballast types: NaHJ ... PZT with special winding tapping point,
whose position is determined by the magnitude of the ignition voltage

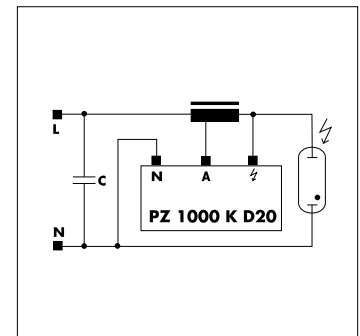

For HS lamps – PZS 1000 K

for standard high-pressure sodium lamps (HS) 50–1000 W
Not suitable for discharge lamp models SUPER, PLUS, XL, etc.
Ignition voltage: approx. 4 kV
No. of pulses: 1 per second
Load capacitance: 20–4000 pF
Suitable ballast types:
NaH ... P with winding tapping point
(20 V voltage difference)

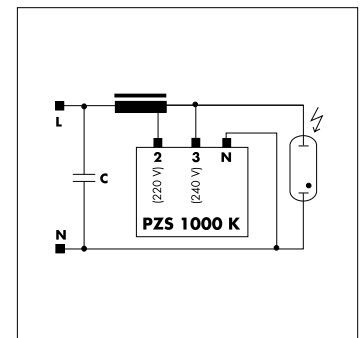

For HI lamps – PZI 1000/1 K

for metal halide lamps (HI)
with an ignition voltage up to 0.9 kV
No. of pulses: 1 per mains period
Load capacitance: max. 10,000 pF
Suitable ballast models: Q...

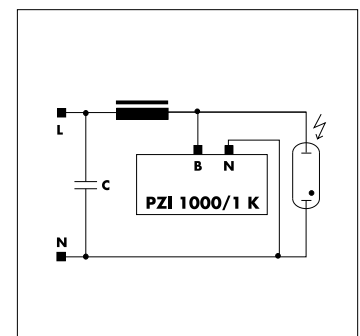

Assembly Instructions for Ignitors

For mounting and installing ignitors

Mandatory regulations

DIN VDE 0100	Erection of low voltage installations
EN 60598-1	Luminaires – part 1: general requirements and tests
EN 61347-1	Operating devices for lamps – part 1: general and safety requirements
EN 61347-2-1	Control gear for lamps; part 2-1: special requirements for ignitors (other than glow starters)
EN 60927	Control gear for lamps; ignitors (other than glow starters); performance requirements
EN 55015	Maximum values and methods of measurement for RFI suppression in electrical lighting installations and similar electrical appliances
EN 61000-3-2	Electromagnetic Compatibility (EMC) – part 3: maximum values – main section part 2: maximum values for mains harmonics (device input current up to and including 16 A per conductor)
EN 61547	Installations for general lighting purposes – EMC immunity requirements

Technical specifications

Operating voltage range

Ignitors can be operated at the specified mains voltage within a tolerance range of $\pm 10\%$.

Max. casing temperature t_c

A maximum casing temperature t_c of 105 °C or 95 °C is specified for superimposed ignitors and pulse ignitors, respectively. Tests carried out during operation must ensure this maximum value is not exceeded. Selecting an ignitor for higher lamp currents can reduce self-heating and thus also the temperature at the t_c measuring point. Details regarding self-heating can be found in the following table. The temperature structure in the luminaires is negatively influenced by ageing lamps.

Minimum ambient temperature t_a

The minimum ambient temperature t_a for all superimposed and pulse ignitors is -30 °C. Ignitors for use in applications with special requirements to the ambient temperature (for example -40 °C) are available on request.

1

2

3

4

5

6

7

8

9

10

Superimposed ignitors – Technical specifications

Voltage V/Hz	Ignitor type	Max. lamp current A	Power loss W	Inherent heating K	Ignition voltage kV	Max. load capacity pF	Max. conductor length between ignitor and lamp* m	Connection terminals (mm ²)		Casing material	Dimensions (dia. x L or L x W x H) length without threaded stud mm
								Screw	Push-in		
220–240/ 50–60	Z 70 S	2	< 0.6	< 5	1.8–2.3	200	2	0.75–4	—	Al	Ø35 x 76
	Z 70 K	2	< 0.6	< 5	1.8–2.3	200	2	0.75–4	—	PC	78 x 34 x 27 81 x 34 x 27
	Z 70 K D20	2	< 0.6	< 5	1.8–2.3	100	2	0.75–4	—	PC	80 x 34 x 30 83 x 34 x 30
	Z 250 S	3.5	< 1.8	< 20	4.0–5.0	100	1	0.75–4	—	Al	Ø35 x 76
	Z 250 K	3.5	< 1.8	< 20	4.0–5.0	100	1	0.75–4	—	PC	78 x 34 x 27 81 x 34 x 27
	Z 250 K D20	3.5	< 1.8	< 20	4.0–5.0	100	1	0.75–4	—	PC	80 x 34 x 30 83 x 34 x 30
	Z 400 S	5	< 3.0	< 25	4.0–5.0	100	1	0.75–4	—	Al	Ø45 x 76
	Z 400 S D20	5	< 3.0	< 25	4.0–5.0	100	1	0.75–4	—	Al	Ø45 x 90
	Z 400 M Z 400 M VS-Power Z 400 M S	5	< 3.0	< 35	4.0–5.0	50	0.5	0.75–4	—	Al	Ø35 x 76
	Z 400 M K	5	< 3.0	< 35	4.0–5.0	50	0.5	0.75–4	—	PC	78 x 34 x 27 81 x 34 x 27
	Z 400 M K VS-Power	5	< 3.0	< 35	4.0–5.0	50	0.5	0.75–4	—	PC	78 x 34 x 27 81 x 34 x 27
	Z 400 M K D20	5	< 3.0	< 35	4.0–5.0	50	0.5	0.75–4	—	PC	80 x 34 x 30 83 x 34 x 30
	Z 750 S	8	< 3.0	< 20	4.0–5.0	100	1	0.75–2.5	—	Al	Ø50 x 90
	Z 1000 S Z 1000 TOP	12	< 6.0	< 35	4.0–5.0	100	1	0.75–2.5	—	Al	Ø50 x 80 83 x 83 x 68
	Z 1000 S D20	12	< 6.0	< 35	4.0–5.0	100	1	0.75–2.5	—	Al	Ø50 x 89
	Z 1000 L	12	< 6.0	< 35	4.0–5.0	2000	20	0.75–2.5	—	Al	Ø50 x 97
	Z 1200/2,5	15	< 7.5	< 40	2.0–2.5	200	2	0.75–2.5	—	Al	Ø50 x 80
	Z 1200/9	15	< 10.0	< 40	7.0–8.0	50	0.5	0.75–2.5	—	Al	Ø50 x 135
	Z 2000 S	20	< 6.0	< 30	4.0–5.0	100	1	0.75–2.5	—	Al	Ø65 x 96
	380–420/ 50–60	Z 1000 S/400V	6	< 3.3	< 28	4.0–5.0	2000	20	0.75–2.5	—	Al
Z 2000 S/400V		12	< 5.0	< 32	4.0–5.0	2000	20	0.75–2.5	—	Al	Ø50 x 88
Z 3500 S/400V		20	< 7.0	< 35	4.0–5.0	100	1	0.75–2.5	—	Al	Ø65 x 96

* With a conductor of, for instance, 100 pF per m (3x2.5 mm²)

Pulse ignitors – Technical specifications

Nominal voltage/ frequency V/Hz	Pulse ignitor type	Casing temperature t _c °C	Ignition voltage kV	Max. load capacity pF	Max. conductor length between ignitor and lamp* m	Connection screw terminals mm ²	Casing material	Dimensions (dia. x L or L x W x H) length without threaded stud mm
PZ 1000 K D20	95	1.8–2.3/ 4.0–5.0	1000	10	0.75–2.5	PC	74 x 34 x 27	
PZI 1000/1 K	95	0.7–0.9	10000	100	0.5–2.5	PC	57 x 28 x 27	
380–420/50–60	PZ 1000/400 V A5	95	4.0–5.0	800	8	0.75–2.5	Al	Ø40 x 80

* With a conductor of, for instance, 100 pF per m (3x2.5 mm²) – wiring must be taken into consideration

Mechanical mounting

Mounting position

Any

Mounting location

Ignitors are designed for installation in luminaires or comparable constructions. Ignitors must be protected against radiation of direct lamp heat by appropriate installation.

Clearance from lamp

The clearance needed between ignitor and lamp is determined by the load capacitance of the conductors and by the type of ignitor pulses. The table on page 70 gives details of the clearance needed for a typical 3-phase lead with a cross-section of 2.5 mm² per conductor.

Casing materials Unmarked in the type description: aluminium; marked "K": polycarbonate

Fastening Via threaded stud M8x10 (Z 2000 S, Z 3500 S/400 V: M12x12)

Dimensions The table on page 70 provides details of ignitor dimensions.

Electromagnetic compatibility (EMC)

Interference Ignitors only generate interference due to the high ignition voltages during lamp ignition. This is classified as click interference and is not evaluated in lighting technology. However, as this interference occurs continuously in the event of old lamps that fail to ignite, operators of lighting systems are legally obliged to exchange such lamps.

Interference immunity

Owing to their design and the materials used, VS ignitors are characterised by high interference immunity and comply with the specified maximum values.

Mains harmonics

Are not observed during lamp ignition. VS ignitors meet the requirements.

Reliability and service life

The service life of an ignitor is dependent on strict compliance with the casing temperature t_c during operation. As the ignitors are only subjected to loads during high-voltage lamp ignition, a service life of 10 years can be expected provided the t_c values are not exceeded. Failure rate: < 0.04%/1,000 hrs.

Electrical installation

Connection terminals

Ignitors feature screw or push-in terminals. For screw terminals a maximum torque value of 0.8 Nm must not be exceeded when connecting the conductor. Push-in terminals are for rigid conductors with a cross section of 0.5–2.5 mm² or respective flexible conductors with ferrule bare end of cores. Stripped lead ends of 8–9 mm are required. Tinned lead ends are not permitted. The permissible conductor cross-sections can be seen in the table on page 70.

Wiring

The ignitors must be wired between ballast and lamp in accordance with the circuit diagrams on pages 62–64. The load capacitances of the wiring must also be taken into account. Distances to lamps should be kept as short as possible.

1

2

3

4

5

6

7

8

9

10

Power switches for street lighting

In view of the drive to cut public spending on energy and also in the light of environmental policies to protect resources, reducing the power consumption of high-pressure discharge lamps is becoming increasingly important.

Power reduction is possible on high-pressure sodium vapour and mercury vapour lamps and is realised with the aid of electronic actuators or by switching the inductance in the luminaire itself with the aid of power switches.

Provided that the lamp still emits an acceptable minimum of light output and uniformity, these lamps can be used to reduce the lighting level of outdoor lighting systems during off-peak traffic periods (e.g. in accordance with DIN 5044 for street lighting). In conjunction with the appropriate ballasts, the VS power switches constitute a perfect all-round solution for power switching purposes. This VS system has been approved by leading lamp manufacturers.

Power switch PR 12 K LC – Power reduction without control line

The new VS PR 12 K LC power switch is capable of setting the period of power-reduced operation based on the measured burning time of a lighting system. This eliminates the time-consuming task of continually adjusting the times of power-reduced operation to suit constantly changing day-night cycles; it also removes the need for making adjustments due to daylight-saving times and is thus suitable for use worldwide (regionally independent).

Function

The intelligent PR 12 K LC power switch does not require a control line to reduce lamp output; it uses the tapping of the ballast. Thanks to an integrated microprocessor, the PR 12 K LC power switch can measure the burning time of the luminaire. This value is then compared to data stored on the chip and used to set the time at which the luminaire will switch over to power-reduced operation. The luminaire will be operated at reduced power for a minimum of six hours (reduced by approx. 40% of the lamp's nominal rating at 50% of luminous flux). This period of power reduction can be extended to a maximum of 10 hours.

Setting periods of power-reduced operation

The power switch is delivered in its default setting – i.e. the dial is set to 'Test (Code 0)'. After the luminaire has been installed, the desired power reduction time must be set using the dial on the power switch. The power-reduction period can be set to a minimum of six hours and can be extended by up to two hours in both directions (i.e. earlier or later). This results in a maximum power-reduction period of 10 hours.

The dial enables the following settings:

Dial settings		t ₁ Hours	Basic power reduction period (hrs)	t ₂ Hours	Total power reduction time (hrs)
Position	Timings				
0	Test	Factory setting: 5 seconds on full load, followed by power reduction			
1	0/0	0	6	0	6
2	0/1	0	6	1	7
3	0/2	0	6	2	8
4	0.5/0	0.5	6	0	6.5
5	0.5/1	0.5	6	1	7.5
6	0.5/2	0.5	6	2	8.5
7	1/0	1	6	0	7
8	1/1	1	6	1	8
9	1/2	1	6	2	9
A	1.5/0	1.5	6	0	7.5
B	1.5/1	1.5	6	1	8.5
C	1.5/2	1.5	6	2	9.5
D	2/0	2	6	0	8
E	2/1	2	6	1	9
F	2/2	2	6	2	10

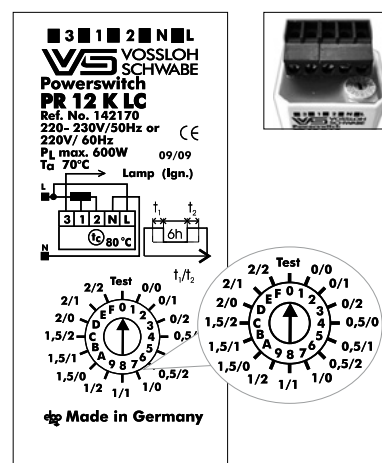

Determining operating/power reduction periods

- The dial is set to the desired period of power reduction, e.g. to position 1 (0/0), which corresponds to a power-reduction period of six hours.
- In the first night, the luminaire is activated by the twilight switch (e.g. at 20:30 hours) and will operate at its nominal rating. After four hours (default setting), the luminaire will be switched down by 40% of the lamp output by the power switch and will then remain in power-reduced operation until the twilight switch turns the system off (e.g. at 06:30 hours).
- During this time, the power switch will measure the entire burning time of the lamp (10 hours in our example).
- The power switch then compares the measured burning period with values stored on the microprocessor. The integrated comparative values of the power switch form the basis for the starting point of power-reduced operation for the following night. The "new" starting time will then be stored by the power switch until the following night.
- In the second night, the lighting system – controlled by the twilight switch and thus dependent on the day/night cycle of the respective region and the time of year – will be activated (and deactivated) at a slightly different time as compared to the first night (either earlier or later, depending on the season)
- With the dial set to position 1, the power switch will thus activate the six-hour period of power-reduced operation after two hours, as per our example, and will then revert to nominal operation before the twilight switch finally sends the signal to switch the lighting system off.
- During the night, the power switch will again measure the entire burning time, compare this value with the stored values and then reset the starting time for power-reduced operation.
- The period of power-reduced operation can be adjusted by changing the dial setting. This period can be extended in both directions (i.e. earlier or later) as detailed in the table on page 72.
- If the dial is, for instance, set to 9 (1/2) this will produce a total period of power-reduced operation of 9 hours (1+6+2). As a result, power-reduced operation will begin one hour earlier than the value determined the night before would ordinarily prescribe and will then extend the minimum period of power-reduced operation by two hours.
- If, in very rare cases, the total burning period of the lighting system should remain under six hours per night, the power switch will activate power-reduced operation after 15 minutes of nominal operation and stay in power-reduced mode until the lighting system is switched off. Switching diagram for power reduced operation.

Switching diagram for power reduced operation

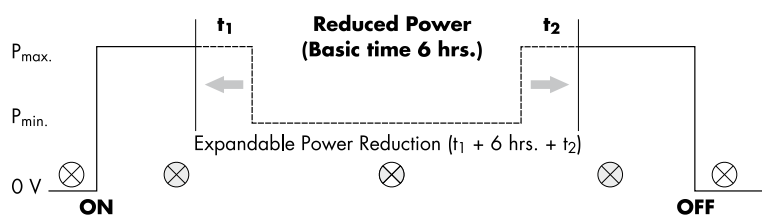

Deactivating reduced-power operation for the night

The functional scope of the PR 12 K LC power switch has been extended with an extra function that permits the operator to deactivate reduced-power operation of the lighting system for a single night. The function can be useful for local festivities or events (e.g. town fêtes) during which it would not be appropriate to operate the local street lighting system at reduced power for safety reasons.

The power switch can be easily programmed to operate the lighting system at normal (i.e. 100%) power for the immediately following night cycle. The power switch is programmed by briefly switching the lighting system on for a period of min. 60 and max. 90 seconds during the day of the event and then switching it off again. The intelligent power switch recognises this command and sets the usual reduced-power operation to zero. The power switch can be successively programmed in this manner as many days in a row as necessary. For every night the lighting system is to be operated at normal (100%) power, the lighting system will have to be switched on for a period of min. 60 and max. 90 seconds during the day. The lighting system will be operated at normal (100%) power in the respective night following day-time activation of the extra function.

1

2

3

4

5

6

7

8

9

10

The power switch does not need to be reprogrammed to return to power-reduced operation of the lighting system. The power switch will automatically return to its original (power-reducing) program if the lighting system is not switched on during the day for a period of min. 60 and max. 90 seconds.

Before testing the extra function, it is important to ensure that the power switch has been in operation for at least one night cycle. Only then will the "learning cycle" start that is required to perform the basic function. After that, the extra function can be activated as described above.

Luminaire testing

The 'Test (Code 0)' dial setting on the power switch is used for luminaire testing during production as well as for direct function tests for "subsequent" installation in the lighting system. After the luminaire is switched on, the lamp is first operated at its nominal rating. After only five seconds, the system will be switched over to power-reduced operation, which will produce a visible change even though the lamp will not yet have attained its full output.

Maintenance work on the lighting system

Maintenance work that requires the lighting system to be switched on for a period of less than two hours will not influence the settings of power switch PR 12 K LC.

Should the lighting system need to be switched on for more than two hours during maintenance work, the PR 12 K LC power switch will activate power-reduced operation after 15 minutes of nominal operation in the following night and will then start to re-measure the total burning time of the lighting system. To determine the starting time of power-reduced operation for subsequent nights, the power switch will again use the stored comparative values.

Switch Units

For power reduction using electronic ballasts with a 1–10 V interface

Suitable for a broad range of lamps

Vossloh-Schwabe's switch units are designed to enable one-step power reduction of lamps (FL, CFL, LED, HS, HI and C-HI) with the help of the respective electronic ballast or converter. To this end, the switch units utilise the 1–10 V interface of the control gear unit. The switch unit is mainly intended for outdoor luminaires in systems with or without a control phase.

Discharge lamps may only be operated at reduced power if they have been expressly approved for this purpose by the manufacturer. In addition, the unit can also be used to dim tubular and compact fluorescent lamps as well as LEDs.

The 1–10 V interface is addressed via an external circuit at the output of the switch unit using a suitably dimensioned resistor. The type of resistor and circuitry are selected by the luminaire manufacturer to suit the desired degree of power reduction.

The switch unit satisfies the provisions of DIN EN 61347 and is suitable for use in outdoor luminaires of protection classes I and II.

Function PR 1-10 V K LC

The intelligent PR 1-10 V K LC switch unit does not require a control line to reduce lamp output.

Thanks to an integrated microprocessor, the PR 1-10 V K LC switch unit can measure the burning time of the luminaire. This value is then compared to data stored on the chip and used to set the time at which the luminaire will switch over to power-reduced operation.

The luminaire will be operated at reduced power for a minimum of six hours (reduced by approx. 40% of the lamp's nominal rating at 50% of luminous flux). This period of power reduction can be extended to a maximum of 10 hours.

Setting periods of power-reduced operation for PR 1-10 V K LC

The PR 1-10 V K LC switch unit is delivered in its default setting – i.e. the dial is set to 'Test (Code 0)'. After the luminaire has been installed, the desired power reduction time must be set using the dial on the switch unit. The power-reduction period can be set to a minimum of six hours and can be extended by up to two hours in both directions (i.e. earlier or later). This results in a maximum power-reduction period of 10 hours.

The dial enables the following settings:

Dial Settings Position	Timings	t ₁ Hours	Basic power reduction period (hrs)	t ₂ Hours	Total power reduction time (hrs)
0	Test	Factory setting: 5 seconds on full load, followed by power reduction			
1	0/0	0	6	0	6
2	0/1	0	6	1	7
3	0/2	0	6	2	8
4	0.5/0	0.5	6	0	6.5
5	0.5/1	0.5	6	1	7.5
6	0.5/2	0.5	6	2	8.5
7	1/0	1	6	0	7
8	1/1	1	6	1	8
9	1/2	1	6	2	9
A	1.5/0	1.5	6	0	7.5
B	1.5/1	1.5	6	1	8.5
C	1.5/2	1.5	6	2	9.5
D	2/0	2	6	0	8
E	2/1	2	6	1	9
F	2/2	2	6	2	10

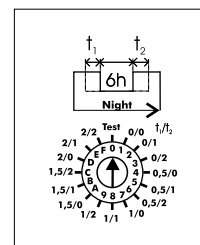
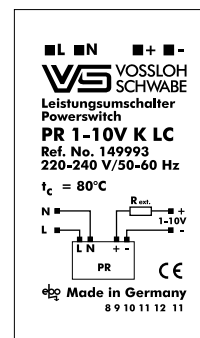

Circuit diagrams for switch units

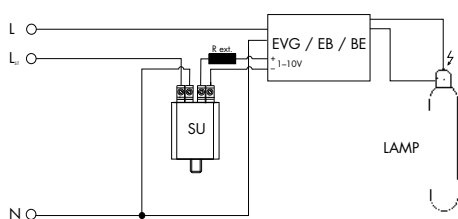

SU 1-10 V K

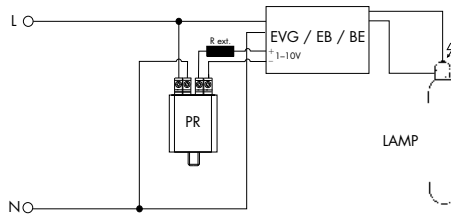

PR 1-10 V K LC

Energy efficiency classification

Based on Directive 2009/125/EC, the European Commission has revised and redefined the limit values from Regulations (EC) 244/2009, (EC) 245/2009 and (EU) 1194/2012 in the third stage with Regulation (EU) 2019/2020 laying down ecodesign requirements for light sources and separate control gear. This regulation will enter into force on 1 September 2021. In the process, the scope was extended to LED light sources and separate control gear of any kind. In addition, limit values for losses in the so-called standby mode, no-load mode and the standby mode in network operation were added. The energy classes for separate control gears are no longer applicable and the limit values of the former class A2 apply. This means that within the EU, only control gears of energy class A2 and better are permitted.

Furthermore, regulation (EU) 2019/2020 sets higher efficiency requirements for the most common T8 lamps from 1 September 2023, which de facto prohibits the placing of T8 lamps on the EU market. In addition, most types of halogen lamps will be banned.

The following table summarises the minimum energy efficiency requirements for separate control gears that will apply in the EU from 1 September 2021.

Minimum efficiency η_{\min} .	Control gears for high-pressure discharge lamps
0.78	$P_{LS} \leq 30 \text{ W}$
0.85	$30 \text{ W} < P_{LS} \leq 75 \text{ W}$
0.87	$75 \text{ W} < P_{LS} \leq 105 \text{ W}$
0.90	$105 \text{ W} < P_{LS} \leq 405 \text{ W}$
0.92	$P_{LS} > 405 \text{ W}$

P_{LS} = measured light source power

Directive EU 245/2009 stipulates limit values governing the energy consumption of LED light sources and separate control gears, regardless of the technology, and applies to both electromagnetic and electronic control gear. Luminaires as so-called surrounding products are not covered by this regulation if both light source and control gear can be removed for inspection without destroying them. If a luminaire cannot be dismantled in the above sense, the luminaire is considered a light source and is subject to the regulation. The area of application is the Member States of the European Union.

However, **outside of the EU** it will continue to be possible to market products of all energy classes, as before, in compliance with local laws and directives.

1

2

3

4

5

6

7

8

9

10

ELECTRONIC BALLASTS



ELECTRONIC BALLASTS

Operating fluorescent lamps with electronic ballasts yields numerous advantages with regard to efficiency and convenience. Further details are provided on the respective product pages and the technical appendix.



3

Electronic Ballasts for TC and T Lamps

Electronic ballasts for compact fluorescent lamps

80

Electronic ballasts for tubular fluorescent lamps

81-83

Technical details for fluorescent lamps

123-143

General technical details

228-236

Glossary

237-239

1

2

3

4

5

6

7

8

9

10

ELXc – Warm Start for TC-F, TC-L Lamps

Electronic built-in ballasts

Casing: metal

Power factor: > 0.96

DC voltage

for operation: 176–264 V

for ignition: 198–264 V

(ELXc 180.866, 280.538: DC voltage cannot be reduced to 176 V)

Push-in terminals: 0.5–1 mm²

For the automatic luminaire wiring:

IDC terminals for leads H05VU 0.5

RFI-suppressed

For luminaires of protection class I

Degree of protection: IP20

For lighting systems with

high switching frequency (> 5/day)

EOL shut down approved acc. to EN 61347 Test 2

M10/M11

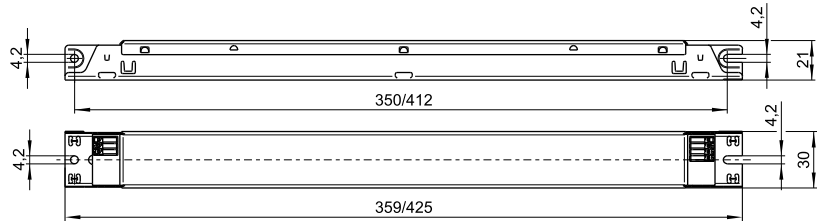

- T5
- TC
- BUILT-IN
- 1-10 V
- T8
- INDEPENDENT
- DALI/PUSH

Lamp				Electronic ballast							System	
Output W	Type	Base	Power consumption W	Type	Ref. No.	Voltage AC 50, 60 Hz V \pm 10%	Energy efficiency	Ambient temperature t _a (°C)	Casing temperature t _c (°C)	Casing	Output W	Luminous factor %
18	TCF/L	2G10/2G11	1 x 16.0	ELXc 140.862	188140	220–240	A2	-15 to 55	max. 70	M10	19.0	109.0
2x18	TCF/L	2G10/2G11	2 x 16.0	ELXc 240.863	188616	220–240	A2 BAT	-15 to 55	max. 70	M10	35.0	105.3
24	TCF/L	2G10/2G11	1 x 22.0	ELXc 140.862	188140	220–240	A2	-15 to 55	max. 70	M10	27.0	109.0
2x24	TCF/L	2G10/2G11	2 x 22.0	ELXc 240.863	188616	220–240	A2 BAT	-15 to 55	max. 70	M10	51.0	106.8
36	TCF/L	2G10/2G11	1 x 32.0	ELXc 140.862	188140	220–240	A2	-15 to 55	max. 70	M10	35.0	101.0
2x36	TCF/L	2G10/2G11	2 x 32.0	ELXc 240.863	188616	220–240	A2 BAT	-15 to 55	max. 70	M10	71.0	98.7
40	TC-L	2G11	1 x 40.0	ELXc 140.862	188140	220–240	A2	-15 to 55	max. 70	M10	46.0	104.0
2x40	TC-L	2G11	2 x 40.0	ELXc 240.863	188616	220–240	A2 BAT	-15 to 55	max. 70	M10	89.0	103.6
55	TC-L	2G11	1 x 55.0	ELXc 180.866	188144	220–240	A2 BAT	-15 to 55	max. 70	M10	62.0	107.3
2x55	TC-L	2G11	2 x 50.0	ELXc 254.865	188618	220–240	A2 BAT	-15 to 50	max. 70	M10	112.0	92.9
			2 x 55.0	ELXc 280.538	188619	220–240	A2 BAT	-15 to 50	max. 70	M11	120.0	100.0
80	TC-L	2G11	1 x 80.0	ELXc 180.866	188144	220–240	A2 BAT	-15 to 55	max. 70	M10	87.0	97.6
2x80	TC-L	2G11	2 x 80.0	ELXc 280.538	188619	220–240	A2 BAT	-15 to 50	max. 70	M11	175.0	100.0

Circuit diagrams see page 131

ELXc – Warm Start for T5 and T8 Lamps

Electronic built-in ballasts
 Casing: metal
 Power factor: ≥ 0.95
 RFI-suppressed
 For luminaires of protection class I

Degree of protection: IP20
 For lighting systems with
 high switching frequency ($> 5/\text{day}$)

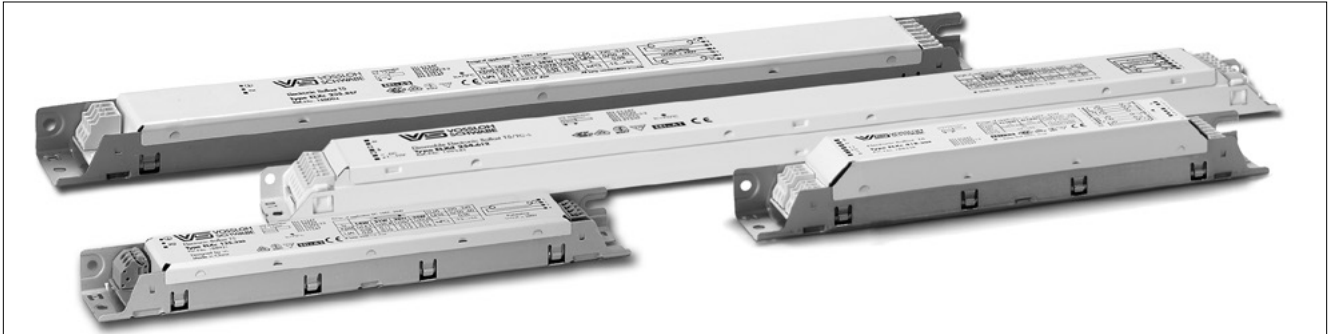

M6

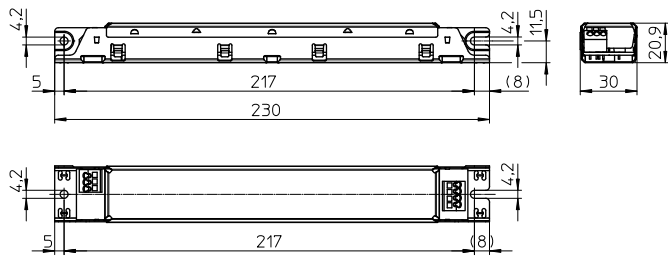

M8

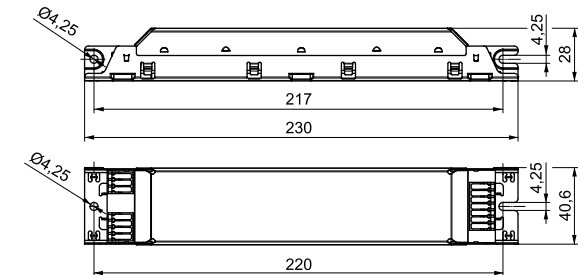

M10/M11

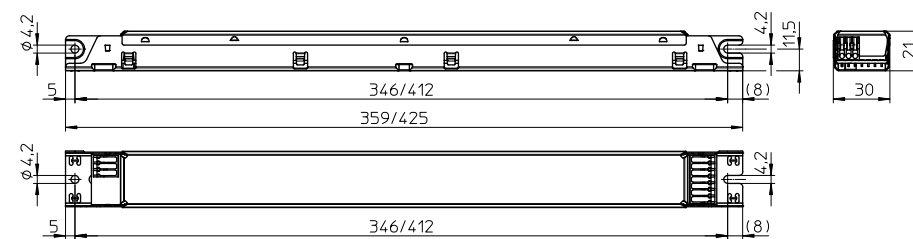

1

2

3

4

5

6

7

8

9

10

ELXc – Warm Start for T5 Lamps

DC voltage

for operation: 176–264 V

for ignition: 198–264 V

(ELXc 149.858, 154.864, 180.866, 280.538:

DC voltage cannot be reduced to 176 V)

Push-in terminals: 0.5–1 mm²

For the automatic luminaire wiring:

IDC terminals for leads H05V-U 0.5

EOL shut down approved

acc. to EN 61347 Test 2 (for T5)

T5 TC BUILT-IN 1–10 V
 T8 INDEPENDENT DALI/PUSH

Lamp				Electronic ballast							System	
Output W	Type	Base	Power con- sumption W	Type	Ref. No.	Voltage AC 50, 60 Hz V±10%	Energy efficiency	Ambient temperature t _a (°C)	Casing temperature t _c (°C)	Casing	Output W	Luminous factor %
For T5 lamps – Casing: M10 and M11												
24	T5	G5	1 x 22.5	ELXc 140.862	188140	220–240	A2 BAT	–15 to 55	max. 70	M10	27.0	114.0
2x24	T5	G5	2 x 22.5	ELXc 240.863	188616	220–240	A2 BAT	–15 to 55	max. 70	M10	51.0	107.4
39	T5	G5	1 x 38.0	ELXc 140.862	188140	220–240	A2 BAT	–15 to 55	max. 70	M10	43.0	107.0
2x39	T5	G5	2 x 38.0	ELXc 240.863	188616	220–240	A2 BAT	–15 to 55	max. 70	M10	82.0	97.9
49	T5	G5	1 x 49.0	ELXc 149.858	188095	220–240	A2 BAT	–15 to 55	max. 70	M10	54.0	102.5
2x49	T5	G5	2 x 49.0	ELXc 249.859	188617	220–240	A2 BAT	–15 to 50	max. 70	M10	113.0	106.6
54	T5	G5	1 x 54.0	ELXc 154.864	188142	220–240	A2 BAT	–15 to 55	max. 65	M10	59.0	101.1
2x54	T5	G5	2 x 54.0	ELXc 254.865	188618	220–240	A2 BAT	–15 to 50	max. 70	M10	119.0	106.0
80	T5	G5	1 x 80.0	ELXc 180.866	188144	220–240	A2 BAT	–15 to 55	max. 70	M10	87.0	97.6
2x80	T5	G5	2 x 80.0	ELXc 280.538	188619	220–240	A2 BAT	–15 to 50	max. 70	M11	175.0	97.2

Circuit diagrams see page 131

ELXc EffectLine – Warm start

Warm start for T5 and T8 lamps – Casing: M6, M8 and M10

DC voltage

for operation: 176–264 V

for ignition: 198–264 V

(not possible for T8)

Push-in terminals with lever opener: 0.5–1.5 mm²

EOL shut down approved

acc. to EN 61347 Test 2 (for T5)

EOL shut down (for T8)

T5 TC BUILT-IN 1-10 V
 T8 INDEPENDENT DALI/PUSH

Lamp				Electronic ballast							System	
Output W	Type	Base	Power consumption W	Type	Ref. No.	Voltage AC 50, 60 Hz V±10%	Energy efficiency	Ambient temperature t _a (°C)	Casing temperature t _c (°C)	Casing	Output W	Luminous factor %
For T5 lamps – Casing: M6 and M10												
14	T5	G5	1 x 14.3	ELXc 135.220	188921	220–240	A2 BAT	–15 to 55	max. 70	M6	17.0	104.8
2x14	T5	G5	2 x 14.3	ELXc 235.221	188922	220–240	A2 BAT	–15 to 55	max. 70	M10	34.5	101.9
21	T5	G5	1 x 20.4	ELXc 135.220	188921	220–240	A2 BAT	–15 to 55	max. 70	M6	23.3	106.9
2x21	T5	G5	2 x 21.4	ELXc 235.221	188922	220–240	A2 BAT	–15 to 55	max. 70	M10	48.3	104.9
28	T5	G5	1 x 26.7	ELXc 135.220	188921	220–240	A2 BAT	–15 to 55	max. 70	M6	29.9	107.5
2x28	T5	G5	2 x 28.7	ELXc 235.221	188922	220–240	A2 BAT	–15 to 55	max. 70	M10	62.1	109.0
35	T5	G5	1 x 32.6	ELXc 135.220	188921	220–240	A2 BAT	–15 to 55	max. 70	M6	36.5	103.0
2x35	T5	G5	2 x 35.6	ELXc 235.221	188922	220–240	A2 BAT	–15 to 55	max. 70	M10	78.2	100.8
For T8 lamps – Casing: M8												
18	T8	G13	1 x 16.0	ELXc 136.207	188704	220–240	A2 BAT	–20 to 55	max. 60	M8	18.4	105.0
2x18	T8	G13	2 x 16.0	ELXc 236.208	188705	220–240	A2 BAT	–20 to 50	max. 60	M8	35.2	106.0
36	T8	G13	1 x 32.0	ELXc 136.207	188704	220–240	A2 BAT	–20 to 55	max. 60	M8	35.4	97.0
2x36	T8	G13	2 x 32.0	ELXc 236.208	188705	220–240	A2 BAT	–20 to 50	max. 60	M8	69.7	98.0
2x58	T8	G13	2 x 50.0	ELXc 258.210	188707	220–240	A2	–20 to 50	max. 65	M8	109.9	105.0

Circuit diagrams see page 131

RELIABLE AND
DURABLE

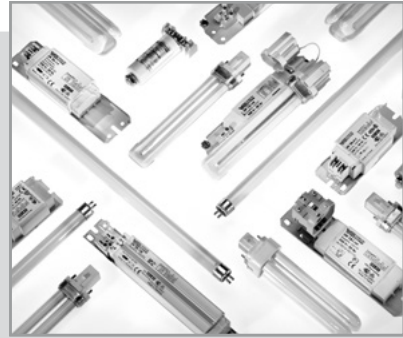

ELECTROMAGNETIC BALLASTS

The following chapter presents Vossloh-Schwabe's broad range of electromagnetic ballasts for compact fluorescent lamps and tubular fluorescent lamps. The variety of available performance properties and shapes satisfies the most diverse design requirements.

Vossloh-Schwabe's electromagnetic ballasts are characterized by extremely tight impedance-value tolerances, which are achieved by individual adjustment of the air gap during the automated production and testing process of the ballasts. This optimises both light output as well as the service life of fluorescent lamps.



3

Electromagnetic Ballasts for TC and T Lamps

Electromagnetic ballasts for compact fluorescent lamps and tubular fluorescent lamps

Standard ballasts

Super low-loss ballasts

86-90

86-89

90

Technical details for fluorescent lamps

General technical details

Glossary

123-143

228-236

237-239

1

2

3

4

5

6

7

8

9

10

Standard Ballasts 4-16 W, 230/240 V

For fluorescent lamps
Shape: 28x41 mm

Vacuum-impregnated with polyester resin
Push-in terminals: 0.5-1.5 mm²
Protection class I
tw 130

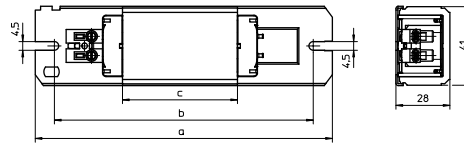
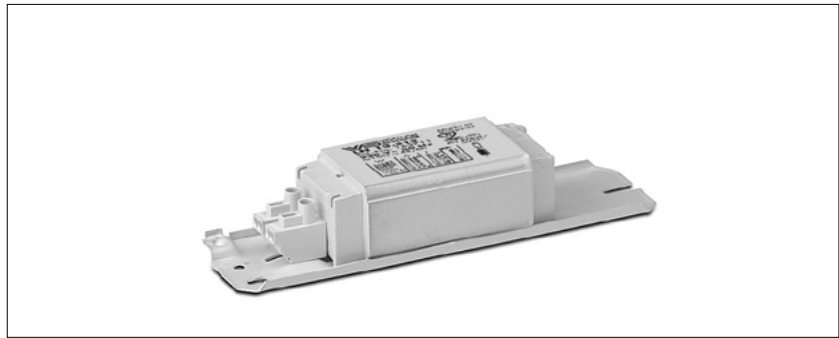

Lamp				Ballast										Capacitor	
Output	Type	Base	Current	Type	Ref. No.	Voltage	a	b	c	Weight	$\Delta t/\Delta t_{an}$	Energy efficiency	C _P	Current	
W			mA			V, Hz	mm	mm	mm	kg	K		μ F	mA	
230 V, 50 Hz															
4	T5 (T16)	G5	170	L4/6/8.304*	163683	230, 50	105	87.5	34	0.32	55/85	B2	2.0	40	
2x4	T5 (T16)	G5	155	L4/6/8.304*	163683	230, 50	105	87.5	34	0.32	55/85	B1	2.0	50	
5	TC-S	G23	180	L7/9/11.307*	163694	230, 50	105	87.5	34	0.32	60/85	B2	2.0	50	
2x5	TC-S	G23	180	LN 13.313*	163711	230, 50	105	87.5	34	0.32	55/80	B2	2.0	70	
6	T5 (T16)	G5	160	L4/6/8.304*	163683	230, 50	105	87.5	34	0.32	55/85	B1	2.0	50	
2x6	T5 (T16)	G5	175	LN 13.313*	163711	230, 50	105	87.5	34	0.32	55/80	B1	2.0	65	
7	TC-S	G23	175	L7/9/11.307*	163694	230, 50	105	87.5	34	0.32	60/85	B2	2.0	50	
2x7	TC-S	G23	160	LN 13.313*	163711	230, 50	105	87.5	34	0.32	55/80	B2	2.0	70	
8	T5 (T16)	G5	145	L4/6/8.304*	163683	230, 50	105	87.5	34	0.32	55/85	B1	2.0	60	
2x8	T5 (T16)	G5	155	LN 13.313*	163711	230, 50	105	87.5	34	0.32	55/80	B1	2.0	85	
9	TC-S	G23	170	L7/9/11.307*	163694	230, 50	105	87.5	34	0.32	60/85	B1	2.0	60	
2x9	TC-S	G23	140	LN 13.313*	163711	230, 50	105	87.5	34	0.32	55/80	B2	2.0	80	
10	TC-D	G24d-1	190	LN 13.313*	163711	230, 50	105	87.5	34	0.32	55/80	B2	2.0	70	
	TC-DD	GR10q	180	LN 13.313*	163711	230, 50	105	87.5	34	0.32	55/80	B2	2.0	70	
11	TC-S	G23	155	L7/9/11.307*	163694	230, 50	105	87.5	34	0.32	60/85	B1	2.0	80	
13	TC-D/TC-T	G24d-1/GX24d-1	175	LN 13.313*	163711	230, 50	105	87.5	34	0.32	55/80	B2	2.0	80	
	T5 (T16)	G5	165	LN 13.313*	163711	230, 50	105	87.5	34	0.32	55/80	B1	2.0	80	
16	TC-DD	GR8/GR10q	195	LN 16.316*	163730	230, 50	105	87.5	34	0.32	60/125	B1	2.0	100	
240 V, 50 Hz															
5	TC-S	G23	180	L7/9/11.411	164335	240, 50	105	87.5	34	0.32	60/85	B2	2.0	50	
2x5	TC-S	G23	180	LN 13.413	164342	240, 50	105	87.5	34	0.32	60/90	B2	2.0	70	
2x6	T5 (T16)	G5	175	LN 13.413	164342	240, 50	105	87.5	34	0.32	60/90	B1	2.0	65	
7	TC-S	G23	175	L7/9/11.411	164335	240, 50	105	87.5	34	0.32	60/85	B2	2.0	50	
2x7	TC-S	G23	160	LN 13.413	164342	240, 50	105	87.5	34	0.32	60/90	B2	2.0	70	
2x8	T5 (T16)	G5	155	LN 13.413	164342	240, 50	105	87.5	34	0.32	60/90	B1	2.0	85	
9	TC-S	G23	170	L7/9/11.411	164335	240, 50	105	87.5	34	0.32	60/85	B1	2.0	60	
2x9	TC-S	G23	140	LN 13.413	164342	240, 50	105	87.5	34	0.32	60/90	B2	2.0	80	
10	TC-D	G24d-1	190	LN 13.413	164342	240, 50	105	87.5	34	0.32	60/90	B2	2.0	70	
	TC-DD	GR10q	180	LN 13.413	164342	240, 50	105	87.5	34	0.32	60/90	B2	2.0	70	
11	TC-S	G23	155	L7/9/11.411	164335	240, 50	105	87.5	34	0.32	60/85	B1	2.0	80	
13	TC-D/TC-T	G24d-1/GX24d-1	175	LN 13.413	164342	240, 50	105	87.5	34	0.32	60/90	B1	2.0	80	
	T5 (T16)	G5	165	LN 13.413	164342	240, 50	105	87.5	34	0.32	60/90	B1	2.0	80	

* Ballasts without CE marking for replacements or markets outside of the EU

Standard Ballasts 14-65 W 230/240/220 V

For fluorescent lamps
Shape: 28x41 mm

Vacuum-impregnated with polyester resin
Push-in terminals: 0.5-1.5 mm²
(for 534584 screw terminals: 1-4 mm²)
Protection class I
tw 130

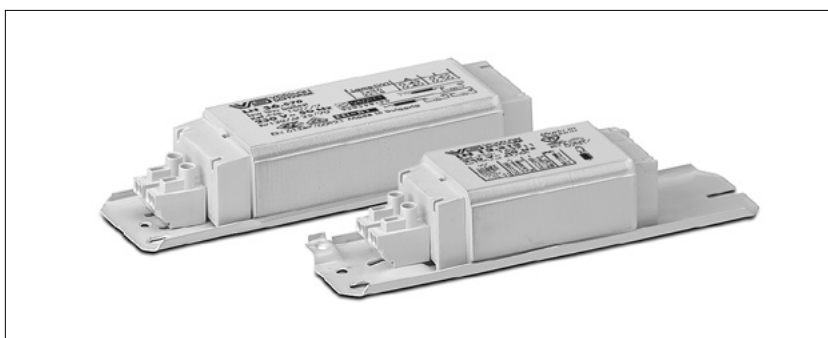

1

2

3

4

5

6

7

8

9

10

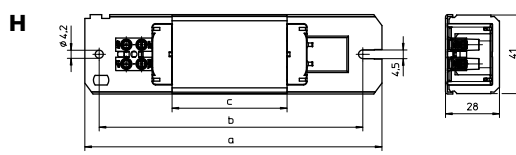
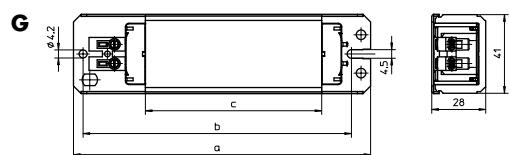
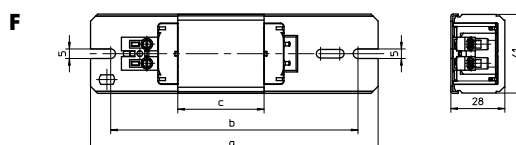
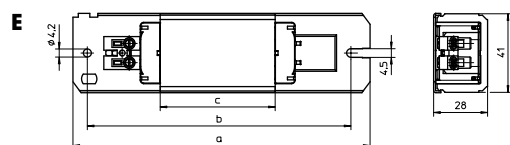
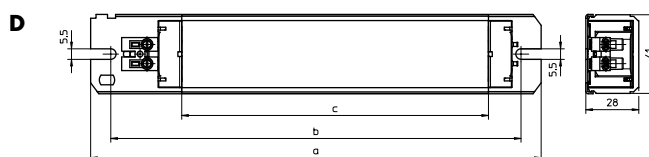
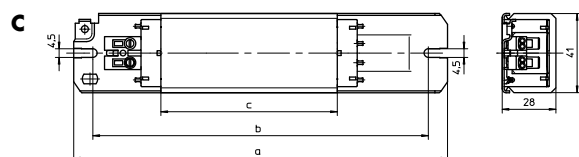
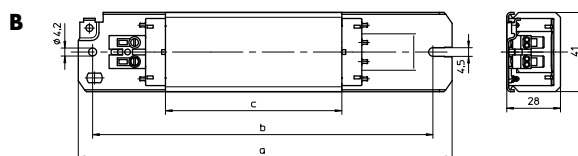
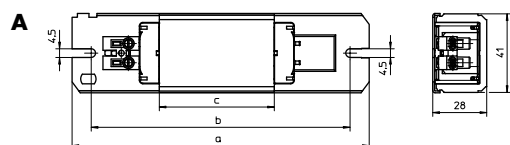

Standard Ballasts 14–65 W, 230/240/220 V

Lamp				Ballast										Capacitor		
Output	Type	Base	Current	Type	Ref. No.	Voltage	Draw- ing	a	b	c	Weight	$\Delta t/\Delta t_{on}$	Energy efficiency	C _p	Current	
W			mA			V, Hz		mm	mm	mm	kg	K		μ F	mA	
230 V, 50 Hz																
14	T8 (T26)	G13	395	LN 18.510*	164572	230, 50	G	155	140	92	0.80	40/65	B2	4.5	150	
15	T8 (T26)	G13	310	LN 15.329*	163861	230, 50	E	155	138	60	0.55	50/80	B2	3.5	120	
2x15	T8 (T26)	G13	340	LN 30.801*	169645	230, 50	E	155	138	60	0.55	55/110	B2	4.0	185	
16	T8 (T26)	G13	200	LN 16.316*	163730	230, 50	A	105	87.5	34	0.32	60/125	B1	2.0	90	
18	TC-D/TC-T	G24d-2/GX24d-2	220	LN 18.319*	163763	230, 50	A	105	87.5	34	0.32	60/140	B1	2.0	110	
	TC-F/TC-L	2G10/2G11	370	LN 18.510*	164572	230, 50	G	155	140	92	0.80	40/65	B1	4.5	120	
				LN 18.131*	530941	230, 50	E	155	138	60	0.55	55/95	B2	4.5	120	
18/20	T8 (T26)/T12 (T38)	G13	370	LN 18.131*	530941	230, 50	E	155	138	60	0.55	55/95	B2	4.5	120	
				LN 18.510*	164572	230, 50	G	155	140	92	0.80	40/65	B1	4.5	120	
22	T-R	G10q	400	LN 30.530*	164680	230, 50	G	155	140	92	0.80	45/65	B2	4.5	200	
25	T12 (T38)	G13	290	L 25.346*	164013	230, 50	E	155	138	60	0.55	45/80	B1	3.5	130	
26	TC-D/TC-T	G24d-3/GX24d-3	325	LN 18.131*	530941	230, 50	E	155	138	60	0.55	55/95	B1	3.5	140	
				LN 26.813*	509502	230, 50	A	110	100	45	0.41	55/145	B2	3.5	140	
28	TC-DD	GR8/GR10q	320	LN 18.510*	164572	230, 50	G	155	140	92	0.80	40/65	B1	3.5	150	
				LN 18.131*	530941	230, 50	E	155	138	60	0.55	55/95	B1	3.5	150	
30	T8 (T26)	G13	365	LN 30.801*	169645	230, 50	E	155	138	60	0.55	55/110	B2	4.5	180	
32	T-R	G10q	450	LN 36.570*	169779	230, 50	G	155	140	92	0.80	35/90	B2	4.0	220	
36	TC-F/TC-L	2G10/2G11	430	LN 36.570*	169779	230, 50	G	155	140	92	0.80	35/90	B1	4.5	210	
				LN 36.511*	164590	230, 50	G	155	140	92	0.80	35/95	B1	4.5	210	
				LN 36.149*	529029	230, 50	E	155	138	60	0.55	55/150	B2	4.5	210	
				L 36.132*	535977	230, 50	F	150	129	45	0.43	65	—	4.5	210	
36-1	T8 (T26)	G13	556	L 36L.342*	538072	230, 50	B	195	180	110	0.87	50/120	B2	6.5	250	
36/40	T-U/TR	2G13/G10q	430	LN 36.570*	169779	230, 50	G	155	140	92	0.80	35/90	B1	4.5	210	
				LN 36.149*	529029	230, 50	E	155	138	60	0.55	55/150	B2	4.5	210	
				L 36.132*	535977	230, 50	F	150	129	45	0.43	65	—	4.5	210	
	T8 (T26)/T12 (T38)	G13	430	LN 36.570*	169779	230, 50	G	155	140	92	0.80	35/90	B1	4.5	210	
				LN 36.149*	529029	230, 50	E	155	138	60	0.55	55/150	B2	4.5	210	
				L 36.132*	535977	230, 50	F	150	129	45	0.43	65	—	4.5	210	
38	TC-DD	GR10q	430	LN 36.570*	169779	230, 50	G	155	140	92	0.80	35/90	B1	4.5	210	
				LN 36.149*	529029	230, 50	E	155	138	60	0.55	55/150	B2	4.5	210	
				L 36.132*	535977	230, 50	F	150	129	45	0.43	65	—	4.5	210	
	T8 (T26)	G13	430	LN 36.570*	169779	230, 50	G	155	140	92	0.80	35/90	B1	4.5	210	
				LN 36.149*	529029	230, 50	E	155	138	60	0.55	55/150	B2	4.5	210	
				L 36.132*	535977	230, 50	F	150	129	45	0.43	65	—	4.5	210	
58	T-U	2G13	670	LN 58.568*	169389	230, 50	D	235	220	160	1.31	35/95	B1	7.0	320	
				LN 58.116*	508186	230, 50	C	195	180	92	0.80	55/160	B2	7.0	320	
58/65	T8 (T26)/T12 (T38)	G13	670	LN 58.568*	169389	230, 50	D	235	220	160	1.31	35/95	B1	7.0	320	

* Ballasts without CE marking for replacements or markets outside of the EU

Standard Ballasts 14–65 W, 230/240/220 V

Lamp				Ballast										Capacitor	
Output	Type	Base	Current	Type	Ref. No.	Voltage	Draw- ing	a	b	c	Weight	$\Delta t/\Delta t_{0n}$	Energy efficiency	C _p	Current
W			mA			V, Hz		mm	mm	mm	kg	K		µF	mA
240 V, 50 Hz															
18	TC-F/TC-L	2G10/2G11	370	L 18.936*	534627	240, 50	F	150	129	45	0.43	70/140	—	4.5	120
	T-U	2G13	370	L 18.936*	534627	240, 50	F	150	129	45	0.43	70/140	—	4.5	120
18/20	T8 (T26)/T12 (T38)	G13	370	L 18.936*	534627	240, 50	F	150	129	45	0.43	70/140	—	4.5	120
24	TC-F/TC-L	2G10/2G11	345	L 18.936*	534627	240, 50	F	150	129	45	0.43	70/140	—	4.5	150
28	TC-DD	GR8/GR10q	320	L 18.936*	534627	240, 50	F	150	129	45	0.43	70/140	—	3.5	150
36/40	T8 (T26)/T12 (T38)	G13	430	L 36.124	534584	240, 50	H	150	140	45	0.43	70/150	—	4.5	210
58	T-U	2G13	670	LN 58.722	534252	240, 50	C	195	180	92	0.80	60/180	B2	7.0	320
58/65	T8 (T26)/T12 (T38)	G13	670	LN 58.722	534252	240, 50	C	195	180	92	0.80	60/180	B2	7.0	320
220 V, 50 Hz															
18	TC-F/TC-L	2G10/2G11	370	L 18.933	534624	220, 50	F	150	129	45	0.43	70/160	—	4.5	120
	T-U	2G13	370	L 18.933	534624	220, 50	F	150	129	45	0.43	70/160	—	4.5	120
2x18	TC-F/TC-L	2G10/2G11	400	L 36.158	530252	220, 50	F	150	129	45	0.43	65	—	4.0	210
18/20	T8 (T26)/T12 (T38)	G13	370	L 18.933	534624	220, 50	F	150	129	45	0.43	70/160	—	4.5	120
2x18/20	T8 (T26)/T12 (T38)	G13	430	L 36.158	530252	220, 50	F	150	129	45	0.43	65	—	4.0	210
24	TC-F/TC-L	2G10/2G11	345	L 18.933	534624	220, 50	F	150	129	45	0.43	70/160	—	4.5	150
26	TC-D/TC-T	G24d-3/GX24d-3	325	L 18.933	534624	220, 50	F	150	129	45	0.43	70/160	—	3.5	140
28	TC-DD	GR8/GR10q	320	L 18.933	534624	220, 50	F	150	129	45	0.43	70/160	—	3.5	150
36	TC-F/TC-L	2G10/2G11	430	L 36.158	530252	220, 50	F	150	129	45	0.43	65	—	4.5	210
36/40	T-U/TR	2G13/G10q	430	L 36.158	530252	220, 50	F	150	129	45	0.43	65	—	4.5	210
	T8 (T26)/T12 (T38)	G13	430	L 36.158	530252	220, 50	F	150	129	45	0.43	65	—	4.5	210
38	TC-DD	GR10q	430	L 36.158	530252	220, 50	F	150	129	45	0.43	65	—	4.5	210
	T8 (T26)	G13	430	L 36.158	530252	220, 50	F	150	129	45	0.43	65	—	4.5	210
58	T-U	2G13	670	L 58.625	164828	220, 50	C	195	180	92	0.80	55/155	—	7.0	320
58/65	T8 (T26)/T12 (T38)	G13	670	L 58.625	164828	220, 50	C	195	180	92	0.80	55/155	—	7.0	320
220 V, 60 Hz															
18	TC-F/TC-L	2G10/2G11	370	L 18.121	528582	220, 60	F	150	129	45	0.43	65/145	—	4.0	150
	T-U	2G13	370	L 18.121	528582	220, 60	F	150	129	45	0.43	65/145	—	4.0	150
2x18	TC-F/TC-L	2G10/2G11	400	L 36.120	509373	220, 60	F	150	129	45	0.43	60/170	—	4.0	210
18/20	T8 (T26)/T12 (T38)	G13	370	L 18.121	528582	220, 60	F	150	129	45	0.43	65/145	—	4.0	190
2x18/20	T8 (T26)/T12 (T38)	G13	430	L 36.120	509373	220, 60	F	150	129	45	0.43	60/170	—	4.0	220
24	TC-F/TC-L	2G10/2G11	345	L 18.121	528582	220, 60	F	150	129	45	0.43	65/145	—	4.0	190
26	TC-D/TC-T	G24d-3/GX24d-3	325	L 18.121	528582	220, 60	F	150	129	45	0.43	65/145	—	3.0	160
36	TC-F/TC-L	2G10/2G11	430	L 36.120	509373	220, 60	F	150	129	45	0.43	60/170	—	4.0	210
36/40	T-U/TR	2G13/G10q	430	L 36.120	509373	220, 60	F	150	129	45	0.43	60/170	—	4.0	220
	T8 (T26)/T12 (T38)	G13	430	L 36.120	509373	220, 60	F	150	129	45	0.43	60/170	—	4.0	220
38	TC-DD	GR10q	430	L 36.120	509373	220, 60	F	150	129	45	0.43	60/170	—	4.0	220
	T8 (T26)	G13	430	L 36.120	509373	220, 60	F	150	129	45	0.43	60/170	—	4.0	230
58	T-U	2G13	670	L 58.657	164870	220, 60	C	195	180	92	0.80	55/140	—	6.0	320
58/65	T8 (T26)/T12 (T38)	G13	670	L 58.657	164870	220, 60	C	195	180	92	0.80	55/140	—	6.0	320

* Ballasts without CE marking for replacements or markets outside of the EU

Super Low-loss Ballasts 18–65 W, 230 V

For fluorescent lamps
Shape: 28x41 mm

Vacuum-impregnated with polyester resin
Push-in terminals: 0.5–1.5 mm²

Protection class I

tw 130

**Energy efficiency: A2,
minimum EU energy efficiency
requirements as of 2017**

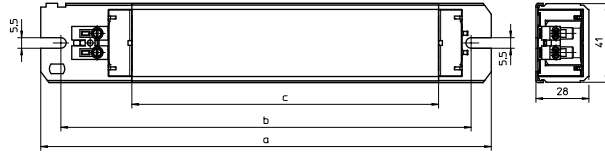
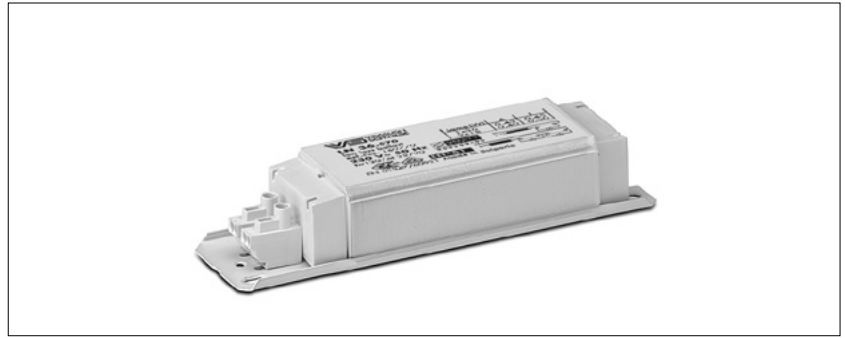

Lamp				Ballast										Capacitor	
Output	Type	Base	Current	Type	Ref. No.	Voltage	a	b	c	Weight	$\Delta t / \Delta t_{an}$	Energy efficiency	C _P	Current	
W			mA			V, Hz	mm	mm	mm	kg	K		μF	mA	
230 V, 50 Hz															
2x18/20	T8 (T26)/T12 (T38)	G13	400	LNN 36.648	560664	230, 50	235	220	160	1.35	25/40	A2	4.5	210	
36/40	T8 (T26)/T12 (T38)	G13	430	LNN 36.648	560664	230, 50	235	220	160	1.35	25/40	A2	4.5	210	
58/65	T8 (T26)/T12 (T38)	G13	670	LNN 58.960	569031	230, 50	235	220	160	1.35	50/80	A2	7.0	320	

1

2

3

4

5

6

7

8

9

10

COMPACT AND VERSATILE



VS LAMPHOLDERS FOR COMPACT FLUORESCENT LAMPS

Vossloh-Schwabe provides a broad range of lampholders for single-ended compact fluorescent lamps, with regard to which the numerous fixing methods make just about any luminaire design possible.

As compact fluorescent lamps generate considerably less heat in comparison to incandescent lamps, the advantages provided by thermoplastics can be fully utilized for lampholder design.

Almost all VS lampholders for compact fluorescent lamps are made of thermoplastic PBT and therefore bear the T marking T140, which refers to the maximum base temperature in accordance with EN 61199 (VDE 0715 T9). The use of this highly heat-resistant material was born of close cooperation between Vossloh-Schwabe and the world's leading lamp manufacturers that also use PBT for producing lamp bases. In connection with fatigue-resistant, stainless steel lamp mounting springs, harmonizing the casing material ensures a permanent and secure lamp fit.



3

Lampholders and Accessories for TC Lamps

2G7 lampholders	94
G23 lampholders	95-96
2G11 lampholders	97
Accessories	98-99
GX53-1 lampholders, accessories	100
Technical details for fluorescent lamps	123-143
General technical details	228-236
Glossary	237-239

1

2

3

4

5

6

7

8

9

10

2G7 Lampholders

For single-ended compact fluorescent lamps TC-SEL

2G7 push-fit lampholder

Casing: PBT GF, white, T140, nominal rating: 2/250

Push-in twin terminals: 0.5–1 mm² (lamp circuit)

Push-in terminals: 0.5–1 mm² (starter circuit)

Rear fixing hole for self-tapping screw
acc. to ISO 1481/7049-ST4.2-C/F

Front fixing holes for screws M3

Locking of the lampholder by a 15° turn

Weight: 13.7 g, unit: 500 pcs.

Type: 35610

Ref. No.: 109235

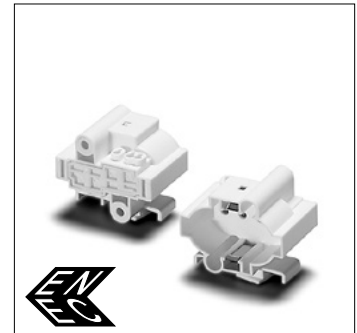
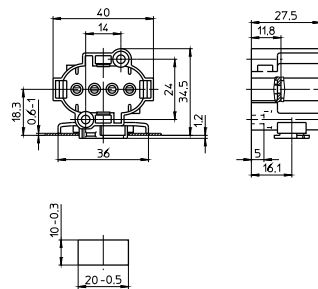

2G7 push-fit lampholder

Casing: PBT GF, white, T140

Nominal rating: 2/250

Push-in twin terminals: 0.5–1 mm² (lamp circuit)

Push-in terminals: 0.5–1 mm² (starter circuit)

Push-fit foot for cut-out 10x20 mm

for wall thickness 0.6–1 mm

Weight: 18 g, unit: 500 pcs.

Type: 35613

Ref. No.: 500574

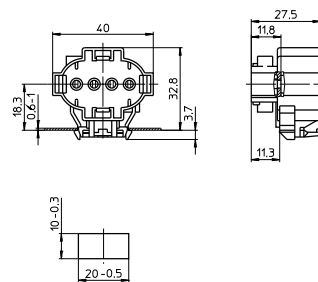

2G7 surface-mounted lampholder

Casing: PBT GF, white, T140, nominal rating: 2/250

Push-in twin terminals: 0.5–1 mm² (lamp circuit)

Push-in terminals: 0.5–1 mm² (starter circuit)

Fixing holes for screws M4

Lateral and rear fixing holes for self-tapping
screws acc. to ISO 1481/7049-ST4.2-C/F

Front fixing holes for screws M3

Weight: 18.1 g, unit: 500 pcs.

Type: 35611

Ref. No.: 109238

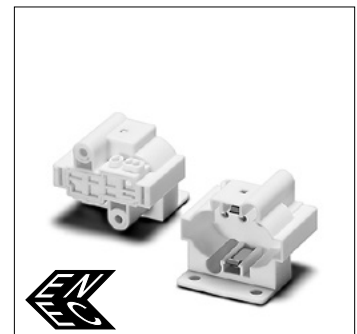
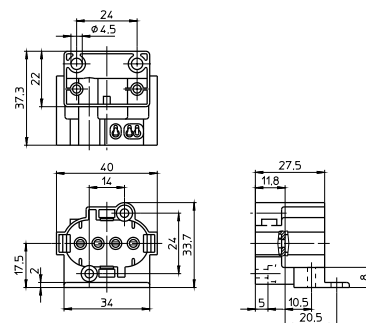

2G7 surface-mounted lampholder

Casing: PBT GF, white, T140

Nominal rating: 2/250

Push-in twin terminals: 0.5–1 mm² (lamp circuit)

Push-in terminals: 0.5–1 mm² (starter circuit)

Rear fixing holes for self-tapping screws

acc. to ISO 1481/7049-ST4.2-C/F

Front fixing holes for screws M3

Weight: 14 g, unit: 500 pcs.

Type: 35612

Ref. No.: 109240

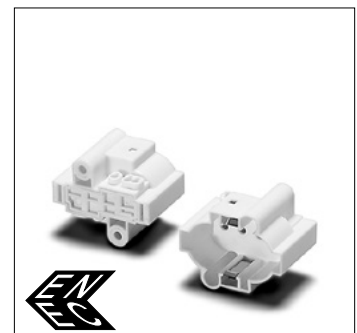
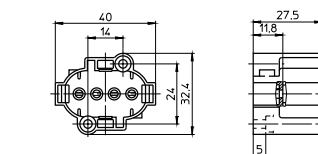

G23 Lampholders

For single-ended compact fluorescent lamps TC-S

If the central hole is used for mounting, make sure there is no risk of rotation.

G23 push-fit lampholder
 Casing: PBT GF, white, T140
 Nominal rating: 2/250
 Push-in twin terminals: 0.5–1 mm²
 Split pins for wall thickness up to 1.2 mm
 Central fixing hole for screw M3
 Weight: 12 g, unit: 500 pcs.
 Type: 35004

Ref. No.: 101298

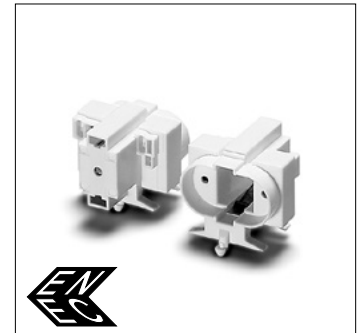
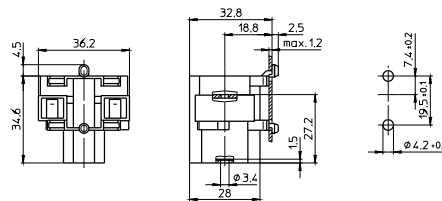

G23 surface-mounted lampholder
 Casing: PBT GF, white, T140
 Nominal rating: 2/250
 Push-in twin terminals: 0.5–1 mm²
 Fixing holes for screws M4
 Central fixing hole for screw M3
 Weight: 12.4 g, unit: 500 pcs.
 Type: 35006

Ref. No.: 101306

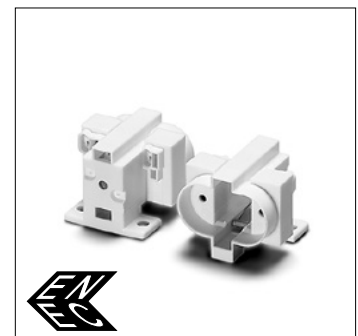
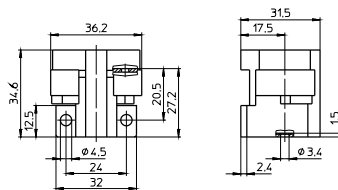

G23 lampholder
 For push-fit on track
 Casing: PBT GF, white, T140, nominal rating: 2/250
 Push-in twin terminals: 0.5–1 mm²
 Lateral fixing holes for self-tapping screws acc. to ISO 1481/7049-ST2.9-C/F
 Fixing holes for screws M4
 Central fixing hole for screw M3
 Weight: 14 g, unit: 500 pcs.
 Type: 35007

Ref. No.: 101310

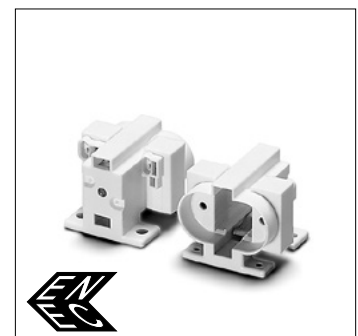
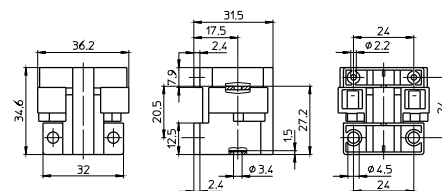

G23 lampholder, for cover caps (see p. 186–188)
 External thread 40x2.5 IEC 60399
 Casing: PBT GF, white, T140, nominal rating: 2/250
 Push-in twin terminals: 0.5–1 mm²
 Central fixing hole for screw M3
 When using the central hole for mounting additional depressions for anti-rotation pins have to be provided.
 For screw rings (see p. 200)
 Weight: 16.3 g, unit: 500 pcs.
 Type: 35010

Ref. No.: 101320

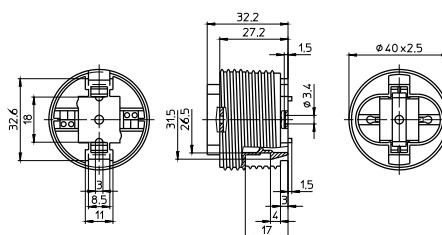

1

2

3

4

5

6

7

8

9

10

Lampholders and Accessories for TC Lamps

G23 lampholder

Casing: PBT GF, white, T140
 Nominal rating: 2/250
 Push-in twin terminals: 0.5–1 mm²
 Lateral pivots for bracket 105820
 Central fixing hole for screw M3
 Weight: 11 g, unit: 500 pcs.
 Type: 35011

Ref. No.: 101324

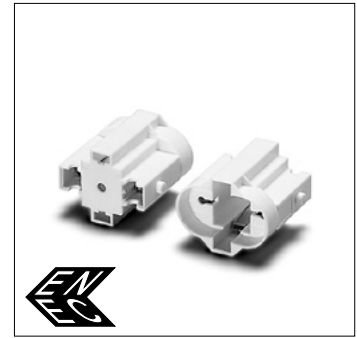
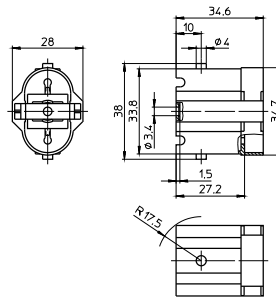

G23 surface-mounted lampholder

Casing: PBT GF, white, T140
 Nominal rating: 2/250
 Push-in twin terminals: 0.5–1 mm²
 Front fixing holes for screws M3
 Rear fixing holes for self-tapping screws
 acc. to ISO 1481/7049-ST4.2-C/F
 Weight: 11.9 g, unit: 500 pcs.
 Type: 35012

Ref. No.: 108898

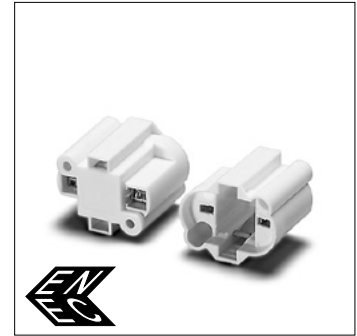
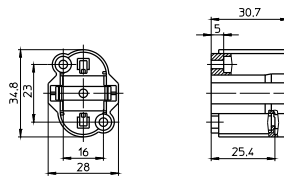

G23 push-fit lampholder

Casing: PBT GF, white, T140
 Nominal rating: 2/250
 Push-in twin terminals: 0.5–1 mm²
 Push-fit foot for wall thickness 0.8–1.3 mm
 Central fixing hole for screw M3
 Weight: 11 g, unit: 500 pcs.
 Type: 35051

Ref. No.: 101344

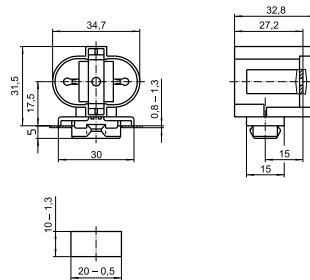

G23 push-fit lampholder

Casing: PBT GF, white, T140
 Nominal rating: 2/250
 Push-in twin terminals: 0.5–1 mm²
 Front split pins for wall thickness 0.8–1.3 mm
 Central fixing hole for screw M3
 Weight: 12 g, unit: 500 pcs.
 Type: 35052

Ref. No.: 101346

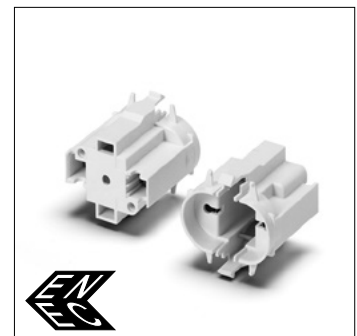
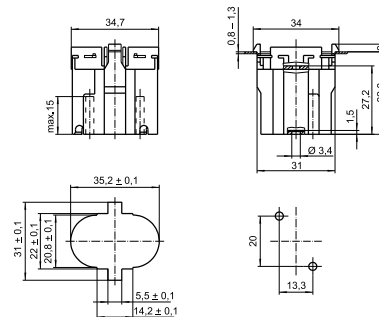

2G11 Lampholders

For single-ended compact fluorescent lamps TC-L

2G11 surface-mounted lampholder

Casing: PBT GF, white, T140, nominal rating: 2/500

Push-in twin terminals: 0.5–1 mm² (lamp circuit)

Push-in terminals: 0.5–1 mm² (starter circuit)

Base fixing holes for screws M4

Rear fixing holes for self-tapping screws
acc. to ISO 1481/7049-ST4.2-C/F

Front fixing holes for screws M3

Weight: 13.7 g, unit: 500 pcs.

Type: 36050

Ref. No.: 101485

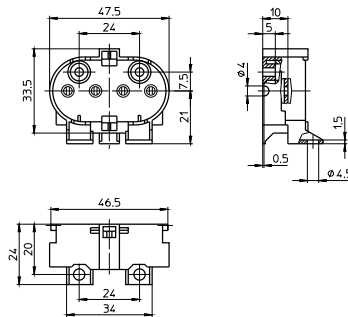

2G11 surface-mounted lampholder

Casing: PBT GF, white, T140, nominal rating: 2/500

Push-in twin terminals: 0.5–1 mm² (lamp circuit)

Push-in terminals: 0.5–1 mm² (starter circuit)

Rear fixing holes for self-tapping screws
acc. to ISO 1481/7049-ST4.2-C/F

Front fixing holes for screws M3

Weight: 12.7 g, unit: 500 pcs.

Type: 36051

Ref. No.: 101489

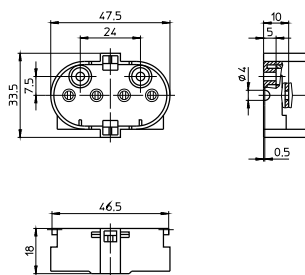

2G11 push-fit lampholder

Casing: PBT GF, white, T140, nominal rating: 2/500

Push-in twin terminals: 0.5–1 mm² (lamp circuit)

Push-in terminals: 0.5–1 mm² (starter circuit)

Lamp position: vertical

Rear fixing holes for self-tapping screws
acc. to ISO 1481/7049-ST4.2-C/F

Front fixing holes for screws M3

Weight: 14.3 g, unit: 500 pcs.

Type: 36052

Ref. No.: 101491

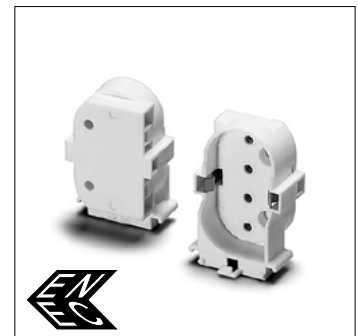
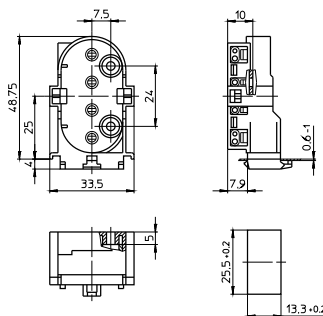

2G11 push-fit lampholder

Casing: PBT GF, white, T140, nominal rating: 2/500

Push-in twin terminals: 0.5–1 mm² (lamp circuit)

Push-in terminals: 0.5–1 mm² (starter circuit)

Rear fixing holes for self-tapping screws
acc. to ISO 1481/7049-ST4.2-C/F

Front fixing holes for screws M3

Option for base wiring

Weight: 14.1 g, unit: 500 pcs.

Type: 36053

Ref. No.: 101493

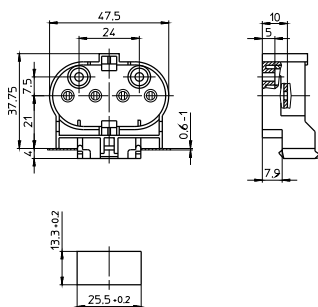

Accessories

For single-ended compact fluorescent lamps

The luminaire manufacturer is responsible for the right choice of accessories.

Lamp supports for TC-S, TC-SEL lamps
 Height adjustable H: 17.5/20.5/23.5 mm
 Push-fit foot for cut-out \varnothing 5.5 mm
 for wall thickness up to 1 mm
 Weight: 0.4/0.8/0.8 g, unit: 500 pcs.
 Type: 35060

Ref. No.: 105775 foot, PC, white

Ref. No.: 105776 bracket, PC, crystal-clear, UV-stabilised

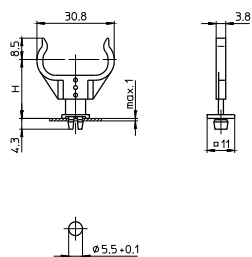

Lamp supports for TC-S, TC-SEL lamps
 Height adjustable H: 27.5/30.5/33.5 mm
 Push-fit foot for cut-out \varnothing 5.5 mm
 for wall thickness up to 1 mm
 Weight: 0.7/0.8/0.8 g, unit: 500 pcs.
 Type: 35061

Ref. No.: 105931 foot, PC, white

Ref. No.: 105776 bracket, PC, crystal-clear, UV-stabilised

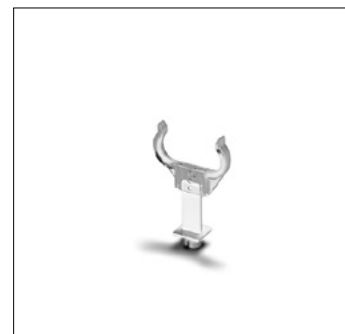
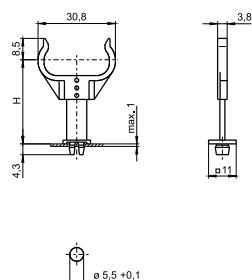

Lamp supports for TC-L lamps
 Height adjustable H: 21/24/27 mm
 Push-fit foot for cut-out \varnothing 5.5 mm
 for wall thickness up to 1 mm
 Weight: 0.4/1.3/1.1 g, unit: 500 pcs.
 Type: 35760

Ref. No.: 105775 foot, PC, white

Ref. No.: 105777 bracket, PC, crystal-clear, UV-stabilised

Ref. No.: 106417 bracket, PC, white, UV-stabilised

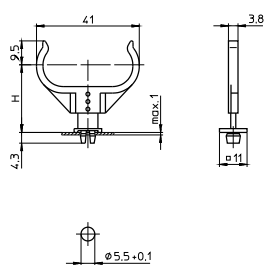

Lamp supports for TC-L lamps
 Height adjustable H: 31/34/37 mm
 Push-fit foot for cut-out \varnothing 5.5 mm
 for wall thickness up to 1 mm
 Weight: 0.7/1.3/1.1 g, unit: 500 pcs.
 Type: 35761

Ref. No.: 105931 foot, PC, white

Ref. No.: 105777 bracket, PC, crystal-clear, UV-stabilised

Ref. No.: 106417 bracket, PC, white, UV-stabilised

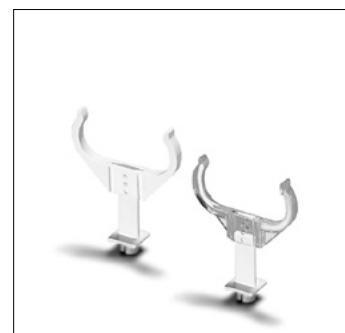
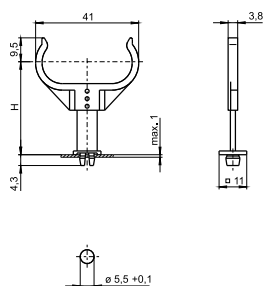

Lampholders and Accessories for TC Lamps

Lamp supports for TC-S, TC-SEL lamps

Material: stainless steel

Weight: 1.3 g, unit: 500 pcs.

Type: 93056 push-fit foot for $\varnothing 5.5$ mm

Ref. No.: 509522

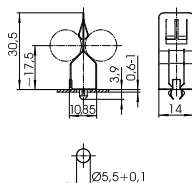

1

2

Lamp supports for TC-F, TC-L lamps

Material: stainless steel

Weight: 1.5 g, unit: 500 pcs.

Type: 93058 push-fit foot for $\varnothing 5.5$ mm

Ref. No.: 509520

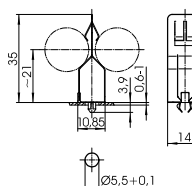

3

4

Lamp support for TC-L lamps

Material: PC, white, UV-stabilised

Push-fit foot for cut-out $\varnothing 5.5$ mm

for wall thickness up to 1 mm

Weight: 0.7 g, unit: 500 pcs.

Type: 36060

Ref. No.: 108878

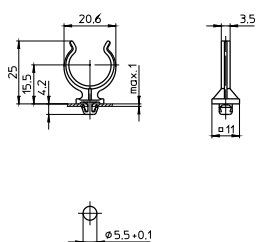

5

6

7

8

9

10

GX53-1 Lampholders, Accessories

For single-ended compact fluorescent lamps with integrated ballasts

GX53-1 lampholder

Casing: PC, white, T100, nominal rating: 2/250

Push-in terminals for through-wiring

for single-core leads: 0.5–1 mm²

for stranded leads:

0.75 mm², tinned lead ends

Fixing holes for screws M3

Weight: 12.8 g, unit: 200 pcs.

Type: 11000

Ref. No.: 530878

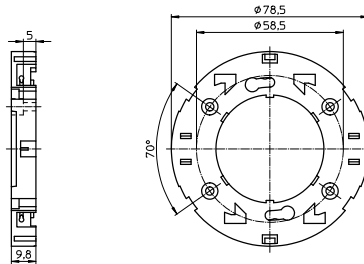

GX53-1 lampholder

Fixing springs for installation into furniture panels

Casing: PC, white, T100, nominal rating: 2/250

Push-in terminals for through-wiring

for single-core leads: 0.5–1 mm²

for stranded leads:

0.75 mm², tinned lead ends

Cut-out: $\varnothing 78^{+0.2}$ mm

Weight: 13.2 g, unit: 200 pcs.

Type: 11010

Ref. No.: 530879

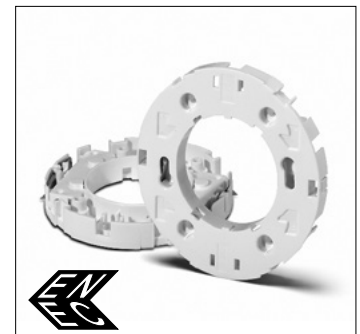
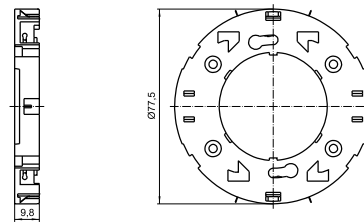

Cord grip/cover plate for GX53-1 lampholders

For leads H03VVH2-F 2X0.75, tinned lead ends

For luminaires of protection class II

Material: PC, white

Weight: 1.6 g, unit: 200 pcs.

Type: 97278

Ref. No.: 504939

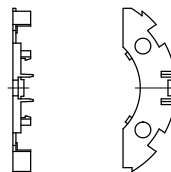

Surface-mounted installation ring

For wood or furniture panels

Material: PC, white

Weight: 10.4 g, unit: 100 pcs.

Type: 97277

Ref. No.: 504938



1

2

3

4

5

6

7

8

9

10

LAMPHOLDERS FOR T5, T8 AND T12 LAMPS



VS LAMPHOLDERS FOR DOUBLE- ENDED FLUORESCENT LAMPS

Vossloh-Schwabe's comprehensive range of lampholders for double-ended fluorescent lamps covers all major fixing methods. Push-through, push-fit and built-in lampholders with split pins or catches are available just as models with screw and push fittings.

High-grade materials for the contacts and thermoplastics for the casings guarantee reliable contacts and a long service life of the components.

Special G13 lampholders for the USA and Canada can be found under www.unvlt.com/products/legacy/lampholders.



3

Lampholders and Accessories for T Lamps

G5 lampholders

G5 lampholders, accessories
G5 lampholders, degree of protection IP65/IP67

104–107

104–106
107

G13 lampholders

G13 push-through lampholders
G13 push-fit lampholders
G13 push-fit twin lampholders
G13 built-in lampholders
G13 surface-mounted lampholders
Accessories for T8 and T12 lamps
G13 lampholders, degree of protection IP65/IP67, accessories

108–115

108
109
109
110–112
112
113
114–115

Technical details for fluorescent lamps

General technical details
Glossary

123–143

228–236
237–239

1

2

3

4

5

6

7

8

9

10

G5 Lampholders, Accessories

For fluorescent lamps T5 (T16)

Max. permitted temperature T_m
on the rear side of the lampholder: 110 °C

G5 push-through/surface-mounted lampholder
Lamp axis push-through lampholder: 13.2 mm
Lamp axis surface-mounted lampholder: 15.2 mm
Casing: PC, white, T110
Nominal rating: 2/500
Push-in terminals: 0.5–1 mm²
Lateral fixing clips for wall thickness 0.5–1.5 mm
Fixing slot for screw M3
Weight: 3.2 g, packaging unit: 1000 pcs.
Type: 09105

Ref. No.: 100305

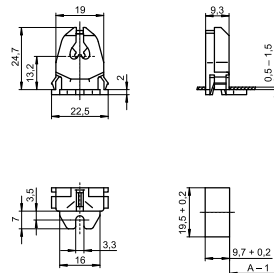

G5 built-in lampholder
Casing: PC, white, T110
Nominal rating: 2/500
Push-in terminals: 0.5–1 mm²
Rear split pins for wall thickness up to 1.2 mm
Weight: 2.6 g, packaging unit: 1000 pcs.
Type: 09205

Ref. No.: 100310

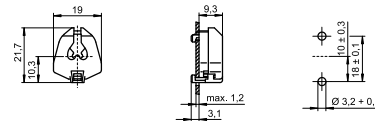

G5 built-in lampholder
Casing: PBT GF, white, rotor: PBT GF, white
T140, nominal rating: 2/500
Push-in twin terminals: 0.5–1 mm²
Lateral fixing clips
Weight: 2.8 g, packaging unit: 1000 pcs.
Type: 09404

Ref. No.: 505732

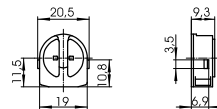

G5 built-in lampholders
Casing: PBT GF, white, rotor: PBT GF, white
T140, nominal rating: 2/500
Push-in twin terminals: 0.5–1 mm²
Rear split pins for wall thickness up to 1.2 mm
Weight: 2.9/3.3 g, packaging unit: 1000 pcs.
Type: 09405/09406

Ref. No.: 505733

Ref. No.: 505734 with spring adjustment

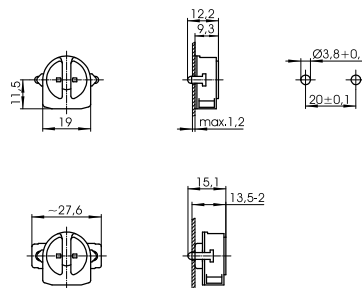

Lampholders and Accessories for T Lamps

G5 push-through lampholders

Lamp axis: 15 mm

Casing: PBT GF, white, rotor: PBT GF, white

T140, nominal rating: 2/500

Push-in twin terminals: 0.5–1 mm²

Lateral fixing clips for wall thickness 0.5–1.5 mm

Weight: 3.5/3.4 g, packaging unit: 1000 pcs.

Type: 09420/09421

Ref. No.: 505737 with stop

Ref. No.: 505739 without stop

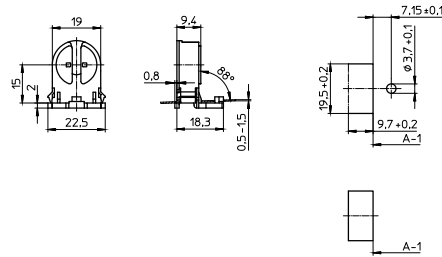

1

2

G5 push-through lampholders

Lamp axis: 20 mm

Casing: PBT GF, white, rotor: PBT GF, white

T140, nominal rating: 2/500

Push-in twin terminals: 0.5–1 mm²

Lateral fixing clips for wall thickness 0.5–1.5 mm

Weight: 4.1 g, packaging unit: 1000 pcs.

Type: 09432/09433

Ref. No.: 545933 with stop

Ref. No.: 545935 without stop

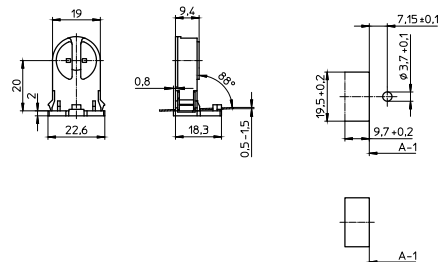

3

4

G5 push-through lampholders

Lamp axis: 25 mm

Casing: PBT GF, white, rotor: PBT GF, white

T140, nominal rating: 2/500

Push-in twin terminals: 0.5–1 mm²

Lateral fixing clips for wall thickness 0.5–1.5 mm

Weight: 4.5 g, packaging unit: 1000 pcs.

Type: 09434/09435

Ref. No.: 545937 with stop

Ref. No.: 545939 without stop

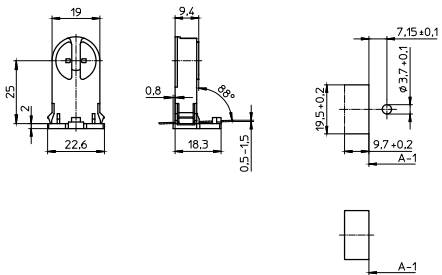

5

6

G5 push-fit lampholder

Lamp axis: 14 mm

Casing: PBT GF, white, rotor: PBT GF, white

T140, nominal rating: 2/500

Push-in twin terminals: 0.5–1 mm²

Rear fixing clips for wall thickness 0.6–1 mm

Base or lateral wiring

Weight: 3.3 g, packaging unit: 1000 pcs.

Type: 09440

Ref. No.: 505747

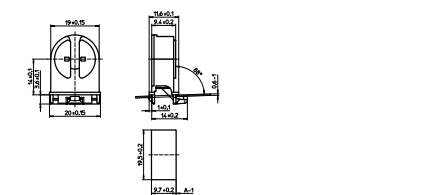

7

8

G5 push-fit lampholder

Lamp axis: 18 mm

Casing: PBT GF, white, rotor: PBT GF, white

T140, nominal rating: 2/500

Push-in twin terminals: 0.5–1 mm²

Rear fixing clips for wall thickness 0.6–1 mm

Base or lateral wiring

Weight: 3.9 g, packaging unit: 1000 pcs.

Type: 09446

Ref. No.: 545894

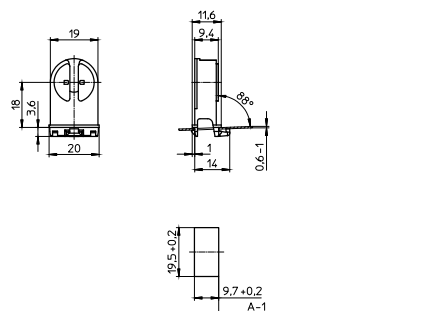

9

10

Lampholders and Accessories for T Lamps

G5 push-fit lampholder

Lamp axis: 23 mm
 Casing: PBT GF, white, rotor: PBT GF, white
 T140, nominal rating: 2/500
 Push-in twin terminals: 0.5–1 mm²
 Rear fixing clips for wall thickness 0.6–1 mm
 Base or lateral wiring
 Weight: 4.2 g, packaging unit: 1000 pcs.
 Type: 09447

Ref. No.: 545896

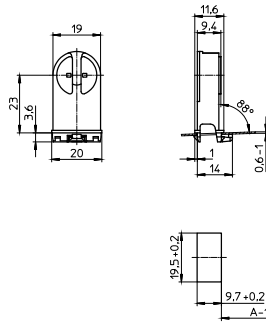

G5 push-fit lampholder

Lamp axis: 11.8 mm
 Casing: PBT GF, white, rotor: PBT GF, white
 T140, nominal rating: 2/500
 Push-in twin terminals: 0.5–1 mm²
 Base split pins for wall thickness up to 1 mm
 Lateral wiring
 Weight: 3.1 g, packaging unit: 1000 pcs.
 Type: 09460

Ref. No.: 505751

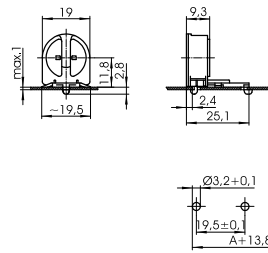

G5 lampholder

For push-fit onto the lamp
 Casing: PBT GF, white, T130
 Nominal rating: 2/500
 Push-in twin terminals: 0.5–1 mm²
 Pin support for reliable contact
 Lamp support 109685 (see below)
 Weight: 3.7 g, packaging unit: 1000 pcs.
 Type: 09170

Ref. No.: 109686

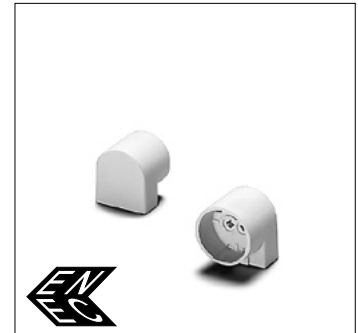
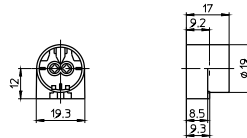

Lamp support for lamps Ø 16 mm
 Material: zinc-coated polished steel

Fixing hole for screw M3.5
 Weight: 1.3 g, packaging unit: 1000 pcs.
 Type: 94088

Ref. No.: 109685

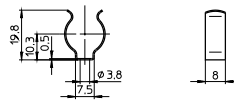

Lamp support for lamps Ø 16 mm
 Material: PC, white, UV-stabilised

Push-fit foot for cut-out Ø 5.5 mm
 Weight: 1 g, packaging unit: 500 pcs.
 Type: 84001

Ref. No.: 500757

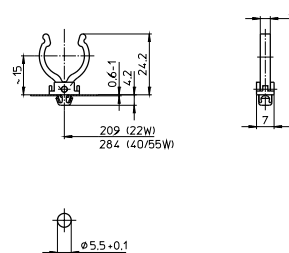

G5 Lampholders, Degree of Protection IP65/IP67

For fluorescent lamps T5 (T16)
For luminaires of protection class I and II

Lampholders protected against dust and jet of water (IP65)
 Dust and watertight lampholders (IP67)
 Pin support for reliable contact
 With spring adjustment

Max. permitted temperature T_m
 on the rear side of the lampholder: 110 °C

G5 push-fit lampholder
 Casing: PC, white, interior part: PBT GF
 T140, nominal rating: 2/500
 Push-in twin terminals: 0.5–1 mm²
 Push-fit foot for wall thickness: 1.4–2 mm
 Weight: 12.7 g, packaging unit: 250 pcs.
 Type: 84108 system 151

Ref. No.: 534073

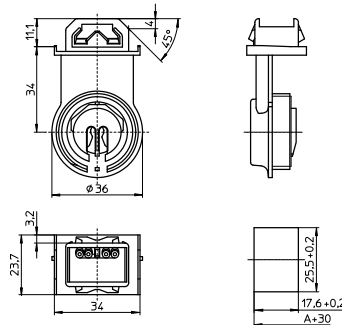

Foot gaskets for system 151
 Weight: 1/1.1 g
 Unit: 1000 pcs.

Type: 98004 degree of protection IP65
Ref. No.: 108267 material: cellular rubber, black

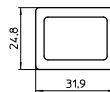

Type: 98011 degree of protection IP67

Ref. No.: 504078 material: silicone, transparent



Screw ring for systems 151
 Ring: PBT GF, white, gasket: silicone
 Weight: 11.8 g, packaging unit: 250 pcs.
 Type: 84103

Ref. No.: 529836

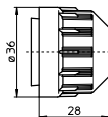

1

2

3

4

5

6

7

8

9

10

G13 Push-through Lampholders

For fluorescent lamps T8 (T26), T12 (T38)

Lampholders with integrated starter holder have push-in twin terminals for the lamp circuit and push-in terminals for the starter circuit.

Pin support for reliable contact

Max. permitted temperature T_m

on the rear side of the lampholder: 110 °C

G13 push-through lampholders for lamps T8 and T12

Lamp axis: 23 mm

Casing: PC, white, frontplate: PBT GF, white

T140, nominal rating: 2/500

Push-in terminals: 0.5–1 mm²

Lateral fixing clips for wall thickness 0.4–2 mm

Weight: 6 g, packaging unit: 1000 pcs.

Type: 27700/27701

Ref. No.: 109330 with stop

Ref. No.: 109331 without stop

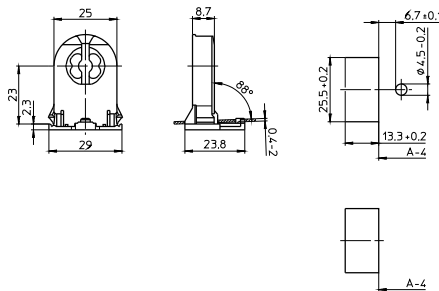

G13 Roticlic push-through lampholders

for lamps T8 and T12

Lamp axis: 23 mm

Casing: PC, white, frontplate: PBT GF, white

T140, nominal rating: 2/500

Push-in terminals: 0.5–1 mm²

Lateral fixing clips for wall thickness 0.4–2 mm

Weight: 6.8 g, packaging unit: 1000 pcs.

Type: 27700/27701

Ref. No.: 546641 with stop

Ref. No.: 546642 without stop

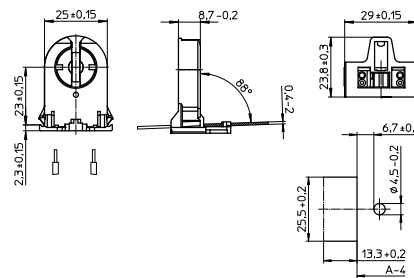

G13 push-through lampholders for lamps T8 and T12

Lamp axis: 31 mm

Casing: PC, white, rotor: PBT, white

T130, nominal rating: 2/500

Push-in terminals: 0.5–1 mm²

Lateral fixing clips for wall thickness 0.6–2 mm

Weight: 9.9 g, packaging unit: 1000 pcs.

Type: 28500/28501

Ref. No.: 100591 with stop

Ref. No.: 100593 without stop

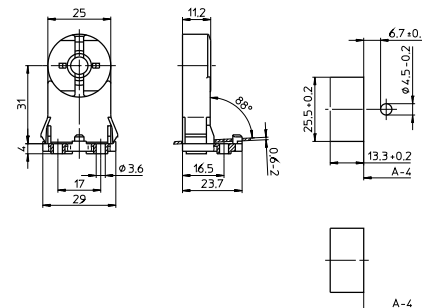

G13 push-through lampholders for lamps T8 and T12

With starter attachment, lamp axis: 31 mm

Casing: PC, white, rotor: PBT, white

T130, nominal rating: 2/250

Push-in terminals: 0.5–1 mm²

Lateral fixing clips for wall thickness 0.6–2 mm

Weight: 16 g, packaging unit: 500 pcs.

Type: 28600/28601

Ref. No.: 100596 with stop

Ref. No.: 100598 without stop

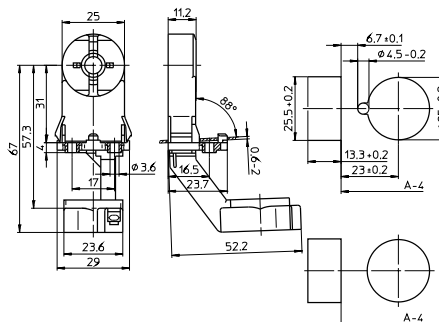

G13 Push-fit Lampholders

For fluorescent lamps T8 (T26), T12 (T38)

Lampholders with integrated starter holder are equipped with big rotor and have push-in twin terminals for the lamp circuit and push-in terminals for the the starter circuit.
Pin support for reliable contact

Max. permitted temperature T_m on the rear side of the lampholder: 110 °C
T-Marking acc. to IEC
IP50 version: push-fit foot with gasket

G13 push-fit lampholder for lamps T8
Lamp axis: 23.5 mm
Casing: PC, white, rotor: PBT GF, white
T130, nominal rating: 2/250
Push-in twin terminals: 0.5–1 mm²
Base split pins for wall thickness up to 1.2 mm
Lampholder foot/luminaire: IP40
Weight: 5.8 g, packaging unit: 1000 pcs.
Type: 27350

Ref. No.: 100548

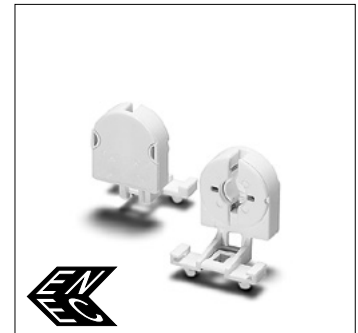
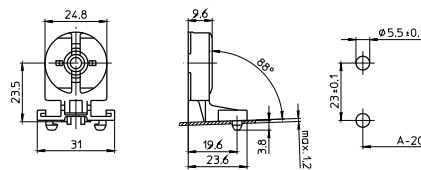

G13 push-fit lampholder for lamps T8 and T12
Lamp axis: 30 mm
Casing: PC, white, rotor: PBT GF, white
T130, nominal rating: 2/250
Push-in twin terminals: 0.5–1 mm²
Base split pins for wall thickness up to 1.2 mm
Lampholder foot/luminaire: IP40
Weight: 5.9 g, packaging unit: 1000 pcs.
Type: 27360

Ref. No.: 100552

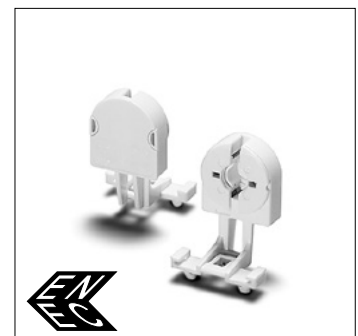
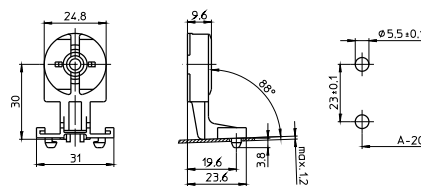

G13 push-fit lampholder for lamps T8 and T12
Lamp axis: 25 mm
Casing: PC, white, rotor: PBT GF, white
T130, nominal rating: 5/500
Lateral and base push-in terminals: 0.5–1 mm²
Push-fit foot for luminaire cut-out 10x20 mm for wall thickness 0.4–1 mm
Weight: 6 g, packaging unit: 500 pcs.
Type: 28921

Ref. No.: 108438

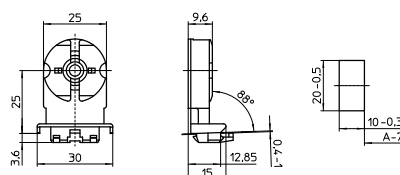

G13 twin lampholders for lamps T8 and T12
Lamp axis: 25 mm
Distance between two lamp axes: 76 mm
Casing: PC, white, rotor: PBT GF, white
T130, nominal rating: 2/500
Base push-in terminals: 0.5–1 mm²
Push-fit foot for wall thickness 0.6–1 mm
Weight: 21 g, packaging unit: 200 pcs.
Type: 22604/22602 without starter attachment

Ref. No.: 108816 with stop

Ref. No.: 100487 without stop

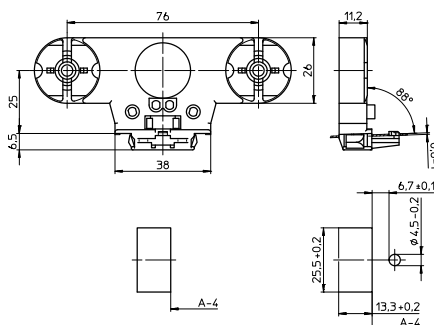

G13 Built-in Lampholders

For fluorescent lamps T8 (T26), T12 (T38)

Lampholders with integrated starter holder are equipped with big rotor and have push-in twin terminals for the lamp circuit and push-in terminals for the the starter circuit. Pin support for reliable contact (except for type 485)

G13 built-in lampholders for lamps T8 and T12
 Lampholder thickness: 13 mm
 Casing: PC, white, frontplate/rotor: PBT GF, white
 T130, nominal rating: 2/500
 Push-in twin terminals: 0.5–1 mm²
 Rear split pins for wall thickness up to 1.2 mm
 Weight: 5/5.5 g, packaging unit: 1000 pcs.
 Type: 47105/47106
Ref. No.: 101685
Ref. No.: 101690 with spring adjustment

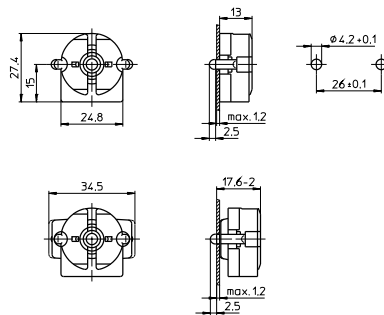

G13 built-in lampholders for lamps T8 and T12
 Lampholder thickness: 9.5 mm
 Casing: PC, white, frontplate/rotor: PBT GF, white
 T130, nominal rating: 2/500
 Push-in twin terminals: 0.5–1 mm²
 Rear split pins for wall thickness up to 1.2 mm
 Weight: 5/5.5 g, packaging unit: 1000 pcs.
 Type: 47505/47506
Ref. No.: 101749
Ref. No.: 101753 with spring adjustment

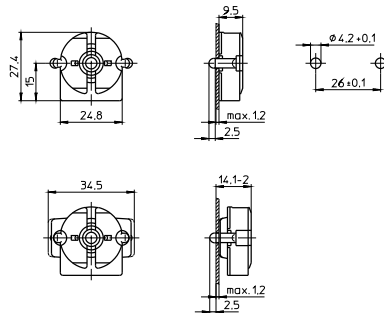

G13 built-in lampholders for lamps T8 and T12
 Lampholder thickness: 13 mm
 Casing: PC, white, frontplate/rotor: PBT GF, white
 T130, nominal rating: 2/500
 Push-in twin terminals: 0.5–1 mm²
 Fixing holes for screws M3
 Weight: 5/6 g, packaging unit: 1000 pcs.
 Type: 47100/47102
Ref. No.: 101674
Ref. No.: 101681 with spring adjustment

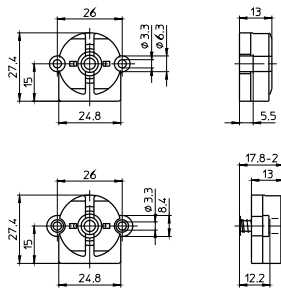

G13 built-in lampholders for lamps T8 and T12
 Lampholder thickness: 9.5 mm
 Casing: PC, white, frontplate/rotor: PBT GF, white
 T130, nominal rating: 2/500
 Push-in twin terminals: 0.5–1 mm²
 Fixing holes for screws M3
 Weight: 5/5.5 g, packaging unit: 1000 pcs.
 Type: 47500/47502
Ref. No.: 101738
Ref. No.: 101740 with spring adjustment

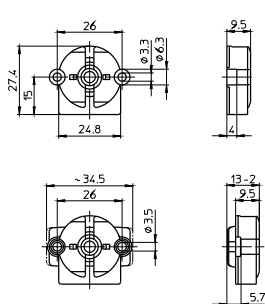

Lampholders and Accessories for T Lamps

G13 built-in lampholders with starter attachment for lamps T8 and T12
 Casing: PC, white, frontplate/rotor: PBT GF, white
 T130, nominal rating: 2/500
 Base push-in terminals: 0.5–1 mm²
 Fixing holes for screws M3
 Weight: 8.7/8 g, packaging unit: 1000 pcs.
 Type: 47200/47600

Ref. No.: 101706 lampholder thickness: 13 mm
Ref. No.: 101765 lampholder thickness: 9.5 mm

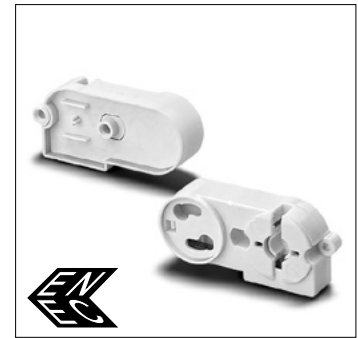
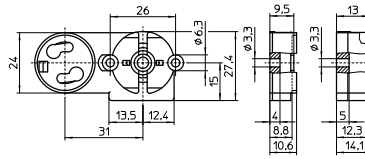

1

2

G13 built-in lampholders with starter attachment for lamps T8 and T12
 Casing: PC, white, frontplate/rotor: PBT GF, white
 T130, nominal rating: 2/500
 Base push-in terminals: 0.5–1 mm²
 Rear split pins for wall thickness up to 1.2 mm
 Weight: 9/9.5/8/8.5 g, packaging unit: 1000 pcs.
 Type: 47205/47206 lampholder thickness: 13 mm

Ref. No.: 101712
Ref. No.: 101716 with spring adjustment
 Type: 47605/47606 lampholder thickness: 9.5 mm
Ref. No.: 101769
Ref. No.: 101773 with spring adjustment

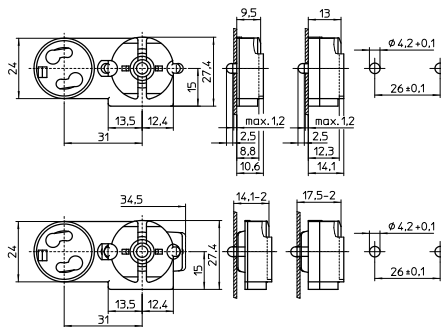

3

4

G13 built-in lampholder for lamps T8 and T12
 Lampholder thickness: 10.7 mm
 Casing: PC, white, frontplate/rotor: PBT GF, white
 T130, nominal rating: 2/500
 Push-in terminals: 0.5–1 mm²
 Lateral fixing clips
 Weight: 4.7 g, packaging unit: 1000 pcs.
 Type: 47504

Ref. No.: 101745

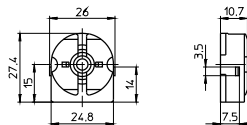

5

6

G13 lampholder
 For push-fitting onto lamps T12
 Lampholder thickness: 9.5 mm
 Casing: PC, white, T110
 Front cover plate: PBT GF, white
 Nominal rating: 2/250
 Push-in terminals: 0.5–1 mm²
 Fixing holes for screws M3
 Weight: 10.5 g, packaging unit: 1000 pcs.
 Type: 47700

Ref. No.: 101781

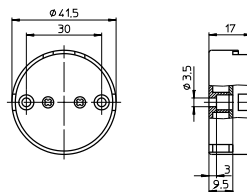

7

8

G13 lampholder
 For push-fitting onto lamps T8
 Lampholder thickness: 9.5 mm
 Casing: PC, white, T110
 Front cover plate: PBT GF, white
 Nominal rating: 2/500
 Push-in terminals: 0.5–1 mm²
 Fixing hole for screw M3
 Weight: 5.3 g, packaging unit: 1000 pcs.
 Type: 47900

Ref. No.: 101784

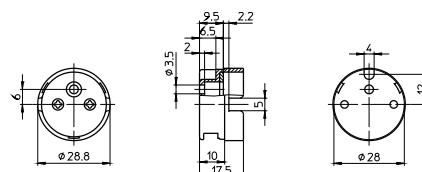

9

10

G13 built-in lampholder with lamp lock
for lamps T8 and T12
Contacts on both sides
Casing: PBT GF, white, T130, nominal rating: 2/500
Screw terminals: 0.5–2.5 mm²
Fixing holes for screws M3
Weight: 12.9/18 g, packaging unit: 500 pcs.
Type: 46100/46101

Ref. No.: 101643

Ref. No.: 101647 with spring adjustment

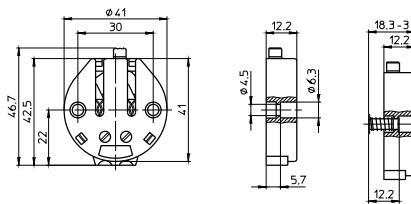

G13 built-in lampholders for lamps T8 and T12
Casing: PC, white, T110
Nominal rating: 2/500
Screw terminals: 0.5–2.5 mm²
Fixing holes for screws M3
5 rotation stops
Weight: 9/10.6 g, packaging unit: 1000 pcs.
Type: 48500/48501

Ref. No.: 101787

Ref. No.: 101789 with spring adjustment

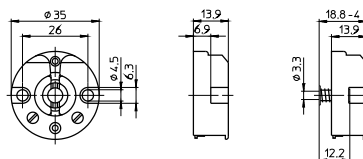

G13 Surface-mounted Lampholders

For fluorescent lamps T8 (T26), T12 (T38)

Pin support for reliable contact
(except for type 485)
Max. permitted temperature T_m
on the rear side of the lampholder: 110 °C

G13 surface-mounted lampholder for lamps T8 and T12
Lamp axis: 25.5 mm
Casing: PC, white, rotor: PBT GF, white, T130
Nominal rating: 2/500
Push-in twin terminals: 0.5–1 mm²
Fixing hole: \varnothing 3.8 mm
Weight: 7.2 g, packaging unit: 500 pcs.
Type: 27722

Ref. No.: 100572

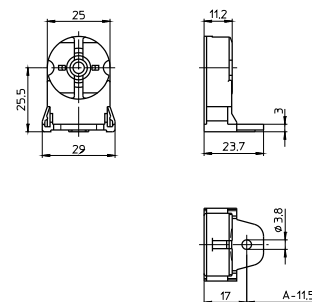

G13 surface-mounted lampholders for lamps T8 and T12
Lamp axis: 25 mm
Casing: PC, white, T110, nominal rating: 2/500
Screw terminals: 0.5–2.5 mm²
Bracket: zinc-coated polished steel
Fixing slots for screws M4
5 rotation stops
Weight: 26/28.1 g, packaging unit: 500 pcs.
Type: 48502/48503

Ref. No.: 101791

Ref. No.: 101793 with spring adjustment

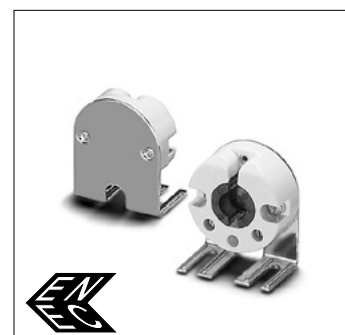
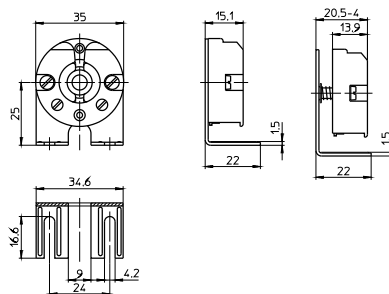

Accessories

For lampholders for fluorescent lamps T8 (T26), T12 (T38)

The luminaire manufacturer is responsible for the right choice of accessories.

Lamp supports for lamps T8
Material: zinc-coated polished steel
Fixing hole for screw M4
Weight: 4.3 g, packaging unit: 500 pcs.
Type: 20400

Ref. No.: 100442

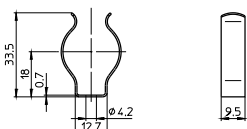

Lamp supports for lamps T8
Material: PC, crystal-clear
Fixing hole for screw M4
Weight: 2 g, packaging unit: 1000 pcs.
Type: 20501

Ref. No.: 100448

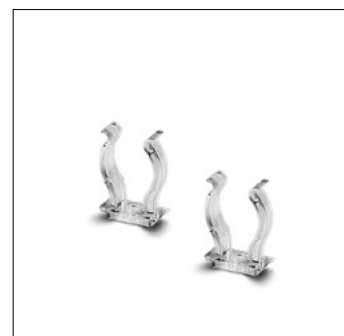
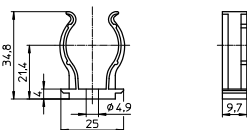

Cable holder
Material: PA, white
Push-fit foot for cut-out \varnothing 4 mm
for wall thickness 0.6–1.2 mm
Weight: 0.2 g, packaging unit: 5000 pcs.
Type: 97147

Ref. No.: 109086

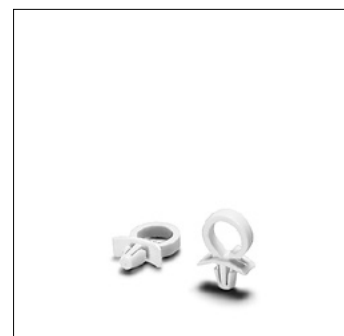
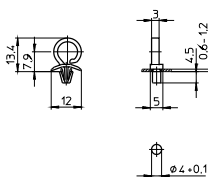

Cable holder
For the automatic luminaire wiring
and manual wiring
Material: PC, white
Degree of protection IP50
Weight: 0.5 g, packaging unit: 5000 pcs.
Type: 97117

Ref. No.: 108845

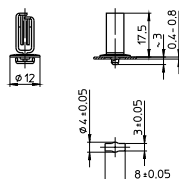

1

2

3

4

5

6

7

8

9

10

G13 Lampholders, Degree of Protection IP65/IP67

**For fluorescent lamps T8 (T26), T12 (T38)
For luminaires of protection class I and II**

Lampholders protected against dust and jet of water (IP65)
Dust and watertight lampholders (IP67)
Pin support for reliable contact with spring adjustment

Max. permitted temperature T_m
on the rear side of the lampholder: 110 °C

G13 push-fit lampholders for lamps T8/T12
Casing: PC, interior part: PBT GF
Rotor: PBT GF, white, T140
Nominal rating: 2/500
Push-in terminals: 0.5–1 mm²
Fixing clips for wall thickness 1.4–2 mm
Screw rings see next page
Weight: 17.3 g, packaging unit: 500 pcs.
Type: 84172 system 163
Ref. No.: 107958 casing white
Ref. No.: 108666 casing grey

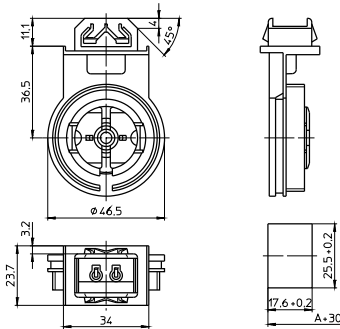

G13 push-fit twin lampholders for lamps T8/T12
Casing: PC, interior part: PBT GF
Rotor: PBT GF, white, T140
Nominal rating: 2/500
Push-in terminals: 0.5–1 mm²
Fixing clips for wall thickness 1.4–2 mm
Screw rings see next page
Weight: 34.2 g, packaging unit: 250 pcs.
Type: 84174 system 164
Ref. No.: 107960 casing white
Ref. No.: 108669 casing grey

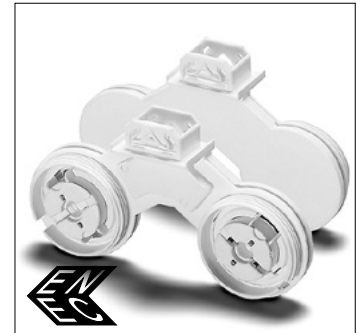
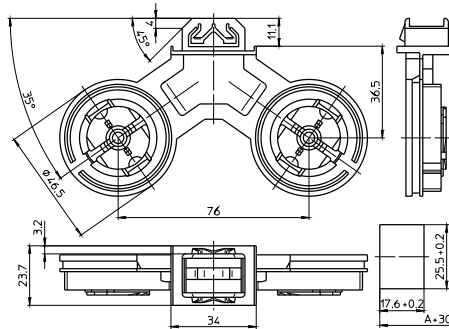

G13 push-fit lampholders for lamps T8/T12
Casing: PC, interior part: PBT GF, T140
Nominal rating: 2/500
Push-in terminals: 0.5–1 mm²
Fixing clips for wall thickness 1.4–2 mm
With slot insertion
Screw rings see next page
Weight: 14.5 g, packaging unit: 250 pcs.
Type: 84175 system 165
Ref. No.: 108608 casing white
Ref. No.: 108614 casing grey

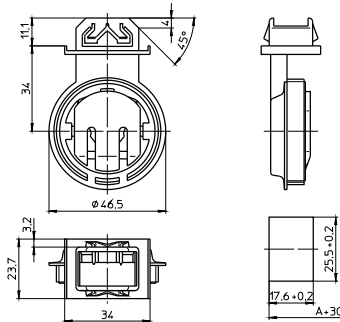

Foot gaskets
For lampholder systems 163, 164, 165
Weight: 1/1.1 g
For degree of protection IP65
Material: cellular rubber
Type: 98004
Ref. No.: 108267
For degree of protection IP67
Material: silicone, transparent
Type: 98011
Ref. No.: 504078

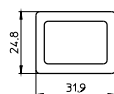

Lampholders and Accessories for T Lamps

G13 lampholder for lamps T8/T12
 Casing: PC, white, interior part: PBT GF, T140
 Nominal rating: 2/500
 Screw fixing foot with tapped holes M4
 Screw rings see below
 With slot insertion
 Weight: 14 g, packaging unit: 250 pcs.
 Type: 84105 system 152
Ref. No.: 521123

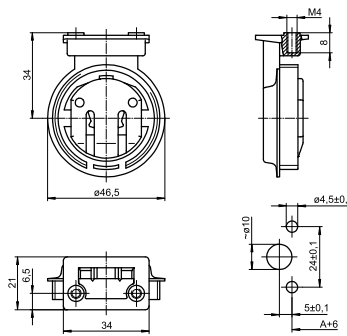

Foot gasket for degree of protection IP65/IP67
 For lampholder system 152
 Material: EPDM, black
 Weight: 1.4 g, packaging unit: 1000 pcs.
 Type: 98085
Ref. No.: 106094

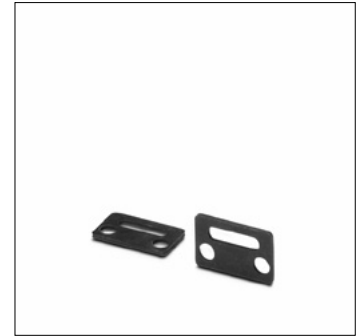
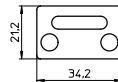

Screw Rings for G13 Lampholders, Degree of Protection IP54, IP65, IP67

For lampholder systems 152, 163, 164, 165

Screw rings
 Ring: PBT GF, gasket: silicone
 Weight: 17/20 g, packaging unit: 500/250 pcs.
 Type: 84122 for lamps T8
Ref. No.: 103710 white
Ref. No.: 103709 grey
 Type: 84123 for lamps T12 or
 for lamps T8 with protection tube \varnothing 38 mm
Ref. No.: 103712 white
Ref. No.: 103711 grey

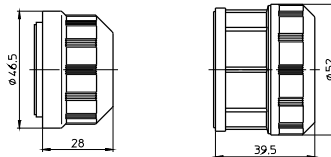

1

2

3

4

5

6

7

8

9

10

OPTIMUM
START WITH
COMPONENTS
MADE BY VS



STARTER HOLDERS AND TERMINAL BLOCKS, ACCESSORIES

Vossloh-Schwabe provides a comprehensive range of miscellaneous accessories for operating fluorescent lamps.

Starter holders

Starters are needed for lamp circuits operated with electromagnetic ballasts. VS provides a number of starter holders with various designs for this purpose. Almost all starter holders are made of polycarbonate and qualify for a T110 temperature rating.

Terminal blocks

Furthermore, Vossloh-Schwabe's product range also includes connection terminals, some of which feature the VDE-approved IDC method in addition to the well-known and installation-friendly push-in connectors. The connection terminals therefore make it possible to automate luminaire wiring and thus wire up several terminals using a single cable.

The range is rounded off by built-in rocker switches.



3

Starter Holders and Terminal Blocks, Accessories

Starter holders, accessories	118
Terminal blocks, accessories	119-121
Built-in rocker switches	122
Technical details for fluorescent lamps	123-143
General technical details	228-236
Glossary	237-239

1

2

3

4

5

6

7

8

9

10

Starter Holders, Accessories

For starters acc. to DIN VDE 0712 part 101,
IEC 60155

Material: PC, white
T110, nominal rating: 2/250

Starter holders

Push-in terminals: 0.5–1 mm², single-core

Front and rear split pins for wall thickness
up to 1.2 mm

Rear of starter holder/luminaire: IP40

Weight: 2.8 g, packaging unit: 1000 pcs.

Type: 02110/02111

Ref. No.: 100061

Ref. No.: 100063 with central stud for
luminaires of protection class II

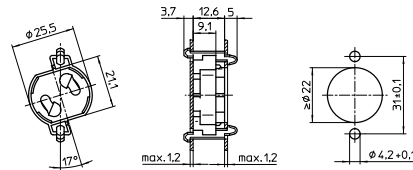

Starter holder

Push-in terminals: 0.5–1 mm²

Rear split pins for wall thickness up to 1.2 mm

Lateral split pins for wall thickness up to 1.25 mm

Rear of starter holder/luminaire: IP40

Weight: 3.7 g, packaging unit: 1000 pcs.

Type: 02120

Ref. No.: 100064

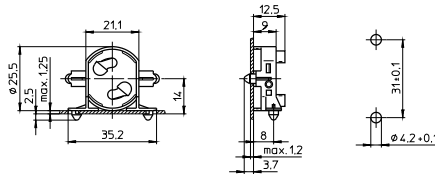

Starter holder

Push-in terminals: 0.5–1 mm²

Rear split pins for wall thickness up to 1.2 mm

Rear of starter holder/luminaire: IP40

Weight: 3.3 g, packaging unit: 1000 pcs.

Type: 43000

Ref. No.: 101627

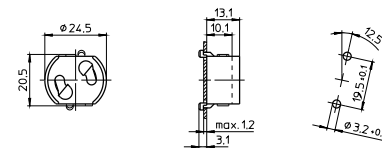

Terminal Blocks, Accessories

Suitable only for solid conductors on the secondary connection

Terminal blocks

Casing: PC, white, T85

Nominal rating: 450 V

Primary connection with release button:

push-in twin terminals 0.5–2.5 mm²/16 A

Secondary connection:

push-in twin terminals 0.5–1.5 mm²/16 A
and 0.5–2.5 mm²/16 A

Connection for X2 RFI-suppression capacitor:

0.5–0.75 mm², capacitor's pins must be insulated (stripped lead ends: 8⁺¹ mm)

For the automatic luminaire wiring:

IDC terminals for leads H05V-U 0.5/6 A

Base split pins for wall thickness 0.6–1 mm

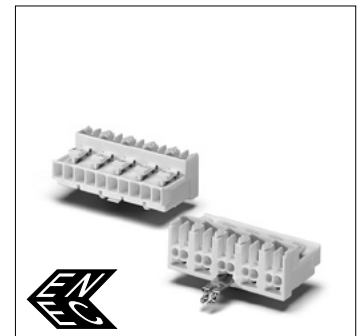
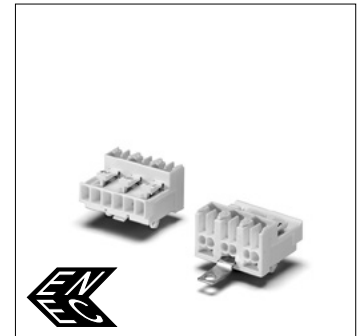
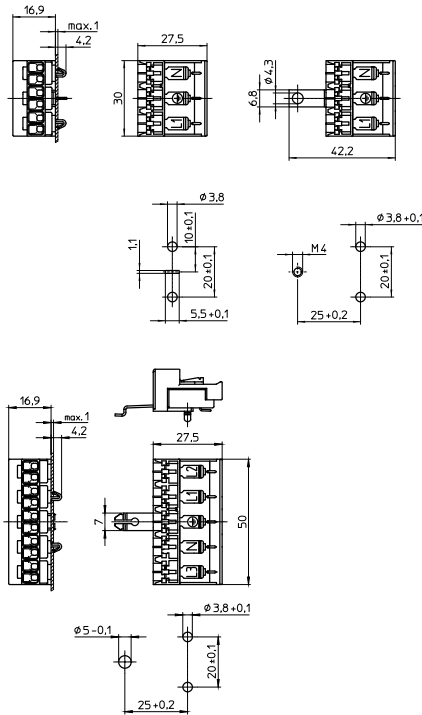

Type	Ref. No.	Number of poles	Earth-contact connection	Mark	Weight (g)	Unit (pcs.)
41510	533313	3-poles	earth spike	N, PE, L1	9.4	500
41520	533314	3-poles	earth strap M4	N, PE, L1	10	500
41530	534948	3-poles	earth finger	N, PE, L1	10	500
41550	533316	5-poles	earth spike	L1, N, PE, L2, L3	15.3	500
41560	533317	5-poles	earth strap M4	L1, N, PE, L2, L3	16	500
41570	534954	5-poles	earth finger	L1, N, PE, L2, L3	16	500

Starter Holders and Terminal Blocks, Accessories

Terminal blocks

Casing: PC, white, T85

Nominal rating: 450 V

Primary connection:

screw terminals 2.5 mm²

Secondary connection:

push-in twin terminals 1.5 mm²

(with IDC contacts: 1 mm²)

push-in terminal 0.5 mm²

For the automatic luminaire wiring:

IDC terminals for leads H05V-U 0.5

Base split pins for wall thickness 0.6–1.2 mm

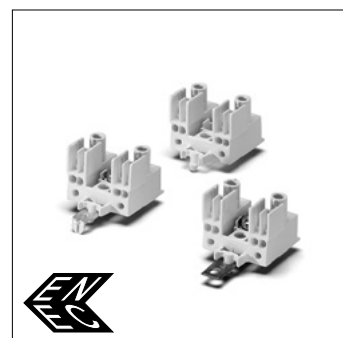
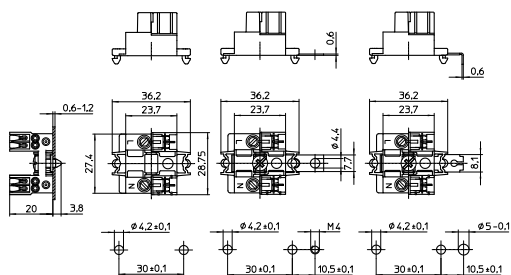

Type	Ref. No.	IDC	Number of poles	Earth-contact connection	Weight (g)	Unit (pcs.)
40660	543793	no	3-poles	not earthed	5.7	1000
40662	543795	no	3-poles	earth strap M4	8.4	1000
40666	543800	no	3-poles	earth finger	8.3	1000
40661	543794	yes	3-poles	not earthed	6	1000
40663	543796	yes	3-poles	earth strap M4	8.7	1000
40667	547801	yes	3-poles	earth finger	8.6	1000

Terminal blocks with fuse holder

Material: PC, white, T70

nominal rating: 250 V

Primary connection: screw terminals 2.5 mm²

Secondary connection:

push-in twin terminals 1.5 mm²

(with IDC contacts: 1 mm²)

push-in terminal 0.5 mm²

For the automatic luminaire wiring:

IDC terminals for leads H05V-U 0.5

With retaining clip for fuses 5x20 mm

With integrated fuse on request

Base split pins for wall thickness 0.6–1.2 mm

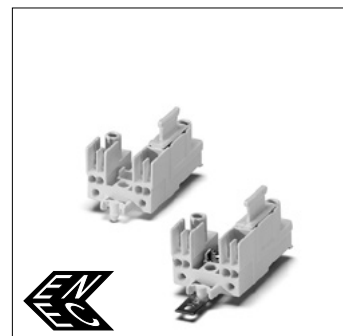
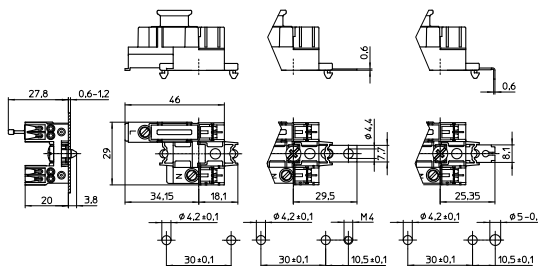

Type	Ref. No.	IDC	Number of poles	Earth-contact connection	Weight (g)	Unit (pcs.)
40670	543802	no	3-poles	not earthed	8.7	1000
40672	543805	no	3-poles	earth strap M4	11.5	1000
40676	543809	no	3-poles	earth finger	14.1	1000
40671	543803	yes	3-poles	not earthed	9.0	1000
40673	543806	yes	3-poles	earth strap M4	11.8	1000
40677	543810	yes	3-poles	earth finger	14.4	1000

Starter Holders and Terminal Blocks, Accessories

Terminal blocks

Casing: PC, grey, T85

Nominal rating: 450 V

Primary connection:

screw terminals 2.5 mm²

Secondary connection:

push-in twin terminal 1.5 mm²

(with IDC contacts: 1 mm²)

push-in terminal 0.5 mm²

For the automatic luminaire wiring:

IDC terminals for leads H05V-U 0.5

Base split pins for wall thickness 0.6–1.2 mm

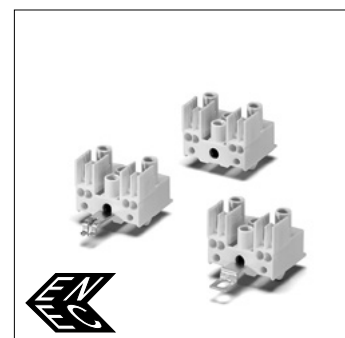
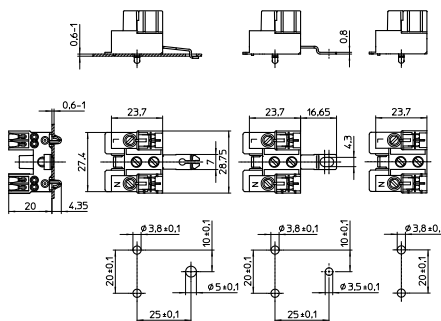

1

2

3

4

Type	Ref. No.	IDC	Type	Number of poles	Earth-contact connection	Weight (g)	Unit (pcs.)
40560	543770	no		3-poles	not earthed	8	1000
40562	543772	no		3-poles	earth strap M4	8.7	1000
40566	543777	no		3-poles	earth finger	8.8	1000
40561	543771	yes		3-poles	not earthed	8.3	1000
40563	543773	yes		3-poles	earth strap M4	9	1000
40567	543778	yes		3-poles	earth finger	9.1	1000

Terminal blocks with fuse holder

Material: PBT, grey, T70

Nominal rating: 250 V

Primary connection: screw terminals 2.5 mm²

Secondary connection:

push-in twin terminals 1.5 mm²

(with IDC contacts: 1 mm²)

push-in terminal 0.5 mm²

For the automatic luminaire wiring:

IDC terminals for leads H05V-U 0.5

With retaining clip for fuses 6x25 mm

With integrated fuse on request

Base split pins for wall thickness 0.6–1.2 mm

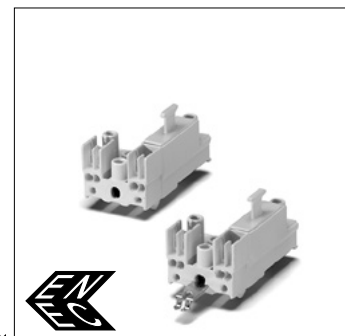
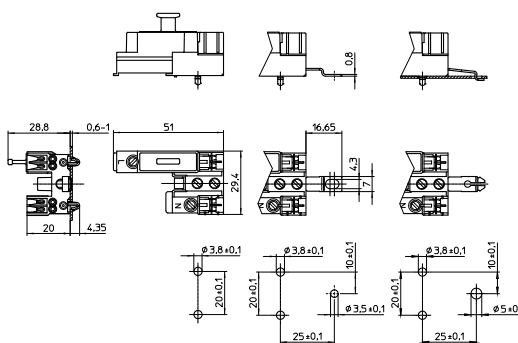

5

6

Type	Ref. No.	IDC	Type	Number of poles	Earth-contact connection	Weight (g)	Unit (pcs.)
40570	543781	no		3-poles	not earthed	11	500
40572	543783	no		3-poles	earth strap M4	11.7	500
40576	543787	no		3-poles	earth finger	11.8	500
40571	543782	yes		3-poles	not earthed	11.3	500
40573	543784	yes		3-poles	earth strap M4	12	500
40577	543788	yes		3-poles	earth finger	12.1	500

7

8

9

10

Built-in Rocker Switches

Built-in rocker switch 1-pole

For cut-out 16x26 mm

Casing: PC, white, T100

Contact pillar and rocker: PBT, white

Terminal: nichrome steel

Nominal rating: 6(2)/250~

Push-in terminals: 0.5–1 mm²

Lateral fixing clips for wall thickness 0.6–1 mm

Weight: 7.2 g, unit: 500 pcs.

Type: 20200

Ref. No.: 100437

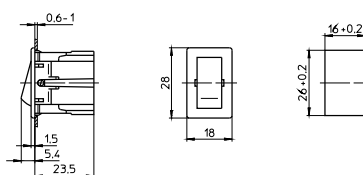

3

Components for Fluorescent Lamps

Electronic ballasts	124-131
Assembly instructions for mounting and installing	125-131
Circuit diagrams	131
Electromagnetic ballasts	132-136
Assembly instructions for mounting and installing	133-136
Circuit diagrams	136
Connection terminals	137
Lampholders for fluorescent lamps	138
Lamp table	139-141
Key to lamp designations	141
Energy efficiency classification	142-143
General technical details	228-236
Glossary	237-239

1

2

3

4

5

6

7

8

9

10

Ballasts for fluorescent lamps

The operation of a fluorescent lamp depends on a ballast that stabilises the lamp's preheat current after connection to the mains and, in conjunction with the starter, also supplies the required lamp ignition voltage after preheating. After ignition, the ballast then serves to limit the lamp current. As fluorescent lamps are characterised by a negative characteristic current-voltage curve, lamp current stabilisation is essential with regard to both the lamp's stable operation and a long service life, which is also dependent on compliance with the starting conditions (preheat current and ignition voltage). Unfavourable starting conditions cause damage to the electrodes every time the lamp is started and thus reduce the lamp's service life. Furthermore, care should be taken to prevent crossdischarge in the electrode area during preheating, which also shortens lamp service life.

Electromagnetic (inductive) ballasts have to be operated in conjunction with starters for lamp ignition and capacitors for blind current compensation. In addition, capacitors for RFI suppression will also be required for certain circuits. Electronic ballasts do not require any additional components.

Electronic ballasts (EB)

VS electronic ballasts are designed for mains voltages of 220 V to 240 V (exceptions are devices for the North American market where the nominal mains voltage is 120 V or 277 V) and are used to operate fluorescent lamps at high frequencies. The lamps are ignited with an internally generated ignition voltage, thereby removing the need for an external starter. The power factor (λ) > 0.95 also removes the need for compensation, unlike with electromagnetic ballasts. Luminaires fitted with electronic ballasts are characterised by low energy consumption as they draw substantially less system power than conventional, inductive applications. This is firstly because the lamp consumes less power to achieve the same luminous flux and secondly because the internal loss of an electronic ballast only amounts to approx. 8% to 10% of the lamp's output. Furthermore, thanks to their modern circuitry, the power input of VS electronic ballasts remains constant even in the event of mains voltage fluctuations, thus ensuring permanently low energy consumption.

VS electronic ballasts permit a broad range of applications. For instance, the VS product range includes many ballast types for multiple lamp operation. These ballasts reduce installation and component costs and thus enable particularly efficient luminaires. Twin-lamp electronic ballasts permit so-called master-slave operation. The lamps of two single-lamp luminaires are operated by a twin-lamp electronic ballast that is built into the so-called master luminaire. The lamp of the slave luminaire is electrically connected to the electronic ballast.

The use of electronic ballasts makes a lighting system both more convenient and efficient to operate:

- reduced power consumption (up to 30%) at undiminished light output
- 50% longer service life
- stabilised lamp output
- overvoltage protection
- no stroboscopic effect
- flicker-free lamp start
- no need for a starter or capacitor
- low wiring effort
- no radiated electromagnetic interference
- low self-heating due to minimal power loss
- automatic shutdown of defective lamps
- automatic restart once the lamp has been changed

Vossloh-Schwabe electronic ballasts are developed on the basis of the latest technological and component standards and are produced using state-of-the-art technology, whereby consideration is taken of our customers' quality standards in our quality assurance system.

Assembly Instructions for Electronic Ballasts

For mounting and installing of electronic ballasts for fluorescent lamps

Mandatory regulations

EN 61347-1	Lamp controlgear – part 1: general and safety requirements
EN 61347-2-3	Lamp controlgear – part 2-3: particular requirements for a.c. supplied electronic ballasts for fluorescent lamps
EN 60929	AC-supplied electronic ballasts for tubular fluorescent lamps
DIN VDE 0100	Erection of low voltage installations
EN 60598-1	Luminaires – part 1: general requirements and tests
EN 61000-3-2	Electromagnetic compatibility (EMC) – part 3: maximum values – main section part 2: maximum values for mains harmonics (device input current up to and including 16 A per conductor)
EN 55015	Maximum values and methods of measurement for RFI suppression in electrical lighting installations and similar electrical appliances
EN 61547	Installations for general lighting purposes – EMC immunity requirements

1

2

3

4

5

6

7

8

9

10

Descriptions of VS electronic ballasts (EBs)

ELXc ballasts (warm start)

ELXc ballasts have a power factor of better than 0.95 and cover the complete capacity range. ELXc ballasts ensure the lamp is started following a defined lamp electrode preheating period of approx. 1–2.5 seconds using a fixed ignition voltage. This particularly gentle lamp start makes over 20,000 lamp starts possible. ELXc ballasts should be used for applications with high switching frequencies (e.g. hotels or offices) where energy savings as well as low maintenance costs are desired. The average service life of these ballasts totals 50,000 hours with a failure rate of $\leq 0.2\%$ per 1,000 operating hours.

To guarantee trouble-free operation and a long service life of the various types of electronic ballast, attention should be paid to the regulations and mounting instructions. In addition, the installation instructions for lighting systems must be observed when installing luminaires with electronic ballasts.

Mechanical mounting

Surface	Solid, flat surface for good heat dissipation required. Avoid mounting on protruding surfaces.
Mounting location	Electronic ballasts must be protected against moisture and heat. Installation in external luminaires: water protection rate of ≥ 4 (e.g. IP54 required)
Fastening	With M4 screws in the designated holes
Heat transfer	If the ballast is destined for installation in a luminaire, sufficient heat transfer must be ensured between the ballast and the luminaire casing. Electronic ballasts should be mounted with the greatest possible clearance to heat sources or lamps. During operation, the temperature measured at the t_c point of the ballast must not exceed the specified maximum value.

Supplement for independent electronic ballasts

Mounting position	Any
Clearance	Min. of 0.10 m from walls, ceilings, insulation Min. of 0.10 m from other electronic ballasts Min. of 0.25 m from sources of heat (lamp)
Surface	Solid; device must not be allowed to sink into insulation materials

Technical specifications

Operating voltage range	AC: 220 to 240 V ($\pm 10\%$) DC: please observe the specifications on the individual product pages
Preheat time	ELXc ballasts $t = 0.5$ or 1.5 to 2.5 seconds (warm start)
Leak current	≤ 0.5 mA per electronic ballast

Product features

Overheating VS EBs for fluorescent lamps are not protected against overheating

Overvoltage protection

AC: up to 48 hours at $U_{NAC} = 320\text{ V}$

DC: no disorders occur with input voltages of up to $U_{NDC} 285\text{ V}$.
 U_{NDC} voltages in excess of 288 V destroy the ballast.

Shutdown of defective lamps

During starting operation, the electronic ballast will detect whether a lamp is connected. If no lamp is present, the ballast will cancel the starting operation. Deactivated lamps or interrupted electrodes are detected and lead to the high-frequency supply being switched off after an unsuccessful ignition attempt. Changing a lamp during operation will lead to the high-frequency supply being switched off.

EOL effect

Up to now, it has not been possible to conclusively reproduce the end-of-life effect under laboratory conditions. However, it can be qualitatively described for fluorescent lamps as follows: when the emitter material of the cathode (i.e. the filament in conventional bi-pin lamps) has been fully consumed or has otherwise lost its emitting power, the emission of electrons is hampered, which leads to a voltage drop at the cathode. Frequent cold starts accelerate active emitter loss.

Operating a lamp with a constant current (an electronic ballasts (EB) provides a near-constant current) results in high dissipation losses that also cause the lamp base and lampholder to heat up and can even cause damage to both. This is often referred to as the EOL effect; from an electrical point of view, this is manifested in the so-called "partial rectifier effect".

The EOL cut-out ensures that a ballast is safely switched off and the lamp base does not overheat at the end of a lamp's service life.

EN 61347-2-3:2011 + AC:2011 describes three possible tests.

The first are now in widespread use and are described in more detail here.

The third test is not conducted at VS.

1. EOL Test 1 (61347-2-3:2011 + AC:2011 17.2)
Asymmetric pulse test
2. EOL Test 2 (61347-2-3:2011 + AC:2011 17.3)
Asymmetric power test
3. EOL Test 3 (61347-2-3:2011 + AC:2011 17.4)
Exposed filament test

The first two tests attempt to simulate the rectifier effect:

- Test 1 pulse switching of rectifying effect
- Test 2 by applying a DC voltage that is constantly higher than required by the lamp.

VS EBs are capable of suitably assessing the altered voltage signal in comparison to normal operation so as to meet EOL requirements.

Protection against transient mains peaks

Values are in compliance with EN 61547 (interference immunity)
(1 kV for AC and 0.5 kV for DC and control conductors).

1

2

3

4

5

6

7

8

9

10

Electrical installation

Wiring The wiring between the mains, electronic ballast and lamp must comply with the respective circuit diagram.
The electronic ballast must be earthed using a toothed washer or similar (protection class I, ignition help, compliance with RFI/BCI standards).
To ensure compliance with RFI-suppression limits, mains conductors should not be wired in parallel to high-frequency carrying lamp conductors; maximum clearance should be ensured and all conductors marked with an * must be kept short. As a general rule, a maximum conductor length should not be exceeded when using conventional conductors (see table on page 131 for precise details). Luminaire must be tested for compliance with the RFI suppression limits stipulated by EN 55015.

Conductors must not exceed 3 m in length in the event of master-slave operation.

Dimmable electronic ballasts are unsuitable for master/slave operation.

Cord grip EBs with cord grip can be used with the following conductors, for instance:

Designation	Lead type
Mains lead	H03VV-F 3X0.75 mm ² or NYM 3X1.5 mm ²
Control lead	H03VV-F 2X0.5 mm ²
Mains and control lead in one lead	H03VV-F 5X0.75 mm ²
Lamp lead	H05WF 4X1 mm ² or 5X1 mm ²

Connection terminals for automatic luminaire wiring (ALF connections)

- Use copper (not stranded) wire
- Required diameter for push-in connection 0.5–1 mm²
- Stripped lead length 8–9 mm
- Required diameter for IDC 0.5 mm², max. Ø 2 mm including insulation, no wire stripping required; mounting requires a special tool

Push-in terminals The integrated terminals can be used with flexible or rigid leads with a crosssection of 0.5–1.5 mm². The stripped lead length ranges between 8.5–9.5 mm for a 3.5 mm terminal grid.

Error current Impulse-resistant leak-current protection must be installed. Distribute the luminaires to phases L1, L2 and L3; install tri-phase FI switches. If permissible, install FI switches with 30 mA leak current; connect no more than 15 luminaires as FI switches can be triggered at half the leak current value.

Tri-phase connection of luminaires with EB

- Prior to operating newly installed lighting systems: check the mains voltage is appropriate to the electronic ballast's mains voltage range (AC, DC).
- The N-type conductor must be properly connected to all luminaires or ballasts.
- Conductors can only be connected or disconnected if the ballast is disconnected from the mains. Attention: N-type conductors must never be disconnected individually or as the first element.
- Insulation resistance test: from L to PE (L and N must not be connected)
- The neutral conductor must be reconnected after completion of the test.

Power factor/compensation

Luminaires with electronic ballasts do not require compensation: power factor ≥ 0.95.

Selection of automatic cut-outs

Dimensioning automatic cut-outs

High transient currents occur when an EB is switched on because the capacitors have to load. Lamp ignition occurs almost simultaneously. This also causes a simultaneous high demand for power. These high currents when the system is switched on put a strain on the automatic conductor cut-outs, which must be selected and dimensioned to suit.

Release reaction The release reaction of the automatic conductor cut-outs comply with VDE 0641, part 11, for B and C characteristics.

No. of electronic ballasts (see the table on pages 131)

The maximum number of VS ballasts applies to cases where the devices are switched on simultaneously. Specifications apply to single-pole fuses. The number of permissible ballasts must be reduced by 20% for multi-pole fuses. The considered circuit impedance equals 400 mΩ (approx. 20 m of conductor [2.5 mm²] from the power supply to the distributor and a further 15 m to the luminaire). Doubling circuit impedance to 800 mΩ increases the possible number of ballasts by 10%.

EB output voltage Electronic ballasts bear the information "U_{OUT}" on their type plates. All subsequently connected components must be designed for this EB output voltage. When using T5 lamps, any components connected to the output side of the EB must be approved for a voltage of ≥ 430 V (especially lampholders).

Lamps and dimmed operation

For lighting systems with dimmable electronic ballasts, Vossloh-Schwabe recommends that fluorescent lamps always be replaced as a **full complement** to maintain uniform lighting levels and colour impressions. New lamps must be burnt in at maximum brightness for approx. 100 hours.
Without restrictions, VS electronic ballasts can be used to operate T8 fluorescent lamps.

Potential interference with IR systems

Operating lamps at frequencies of 20 to 50 kHz can cause interference with infrared systems (remote controls, sound transmission, personal pager systems).
Countermeasures: optical filters, switching to infrared systems with higher carrier frequencies (over 400 kHz).

Electromagnetic Compatibility (EMC)

Vossloh-Schwabe's electronic ballast range was developed in accordance with valid EMC standards (interference, interference immunity and mains harmonics) and specially designed to ensure safe compliance with the limiting values.

It is assumed that that any remarks regarding conductor wiring and conductor length in the instructions for installing electronic ballasts in luminaires or for independent ballasts will be observed.

Vossloh-Schwabe electronic ballasts are also tested in commercially available luminaires in addition to the CISPR 30 sample luminaires.

Mains harmonics: the maximum values laid down in EN 61547 (Interference Immunity) are satisfied.

1

2

3

4

5

6

7

8

9

10

Additional information

Information on the installation of electronic ballasts for optimising EMC

To ensure good radio interference suppression and the greatest possible operating safety, the following points should be observed when installing electronic ballasts:

- Conductors between the EB and the lamp (HF conductors) must be kept short (reduction of electromagnetic interference). High-potential lamp conductors must be kept as short as possible, in particular with tubular lamps. Lamp conductors of this kind are labelled with an * in the wiring diagram on the type plate (see page 131).
- Mains and lamp conductors must be kept separate and if possible should not be laid in parallel to one another. The distance between HF and mains conductors should be as large as possible, ideally > 5 cm. (This prevents the induction of interference between the mains and lamp conductors.)
- The mains conductor within the luminaire must be kept short (to reduce the induction of interference).
- Devices must be properly earthed. EBs require secure contacts to the luminaire casing or must be earthed using a PE connection. This PE connection should be effected using an independent conductor to achieve better dissipation of the leak current. EMC improves at frequencies greater than 30 MHz.
- The mains conductor must not be laid too close to the EB or the lamp (this is especially important in the event of through-wiring).
- Mains and lamp conductors must not be crossed. Should this be impossible to avoid, conductors should be crossed at right angles to one another to avoid inducing interference between mains and HF conductors.
- Should conductors be wired through metal parts, such conductors must always be additionally shielded (e.g. with an insulating sleeve or grommet).

Temperature

Reference point temperature t_c

The safe operation of electronic ballasts is dependent on the maximum permissible temperature not being exceeded at the measuring point. Vossloh-Schwabe has determined a casing temperature measuring point – $t_{c \max}$ – on all EB casings. To avoid shortening the service life or diminishing operating safety, the stipulated maximum temperature must not be exceeded at this t_c point. This point is determined by testing the convertor during normal, IEC-standardised operation at the specified ambient temperature (t_a), which is also indicated on the type plate. As both the design-related ambient temperature and the ballast's inherent heat, as determined by the installed load, are subject to great variation, the casing temperature should be tested at the t_c point under real installation conditions.

Ambient temperature t_a

The ambient temperature – as specified on every EB – denotes the permissible temperature range within the luminaire.

Reliability and service life

If the max. temperature at the t_c reference point (as specified on the type plate and the technical documentation of the ballast) is not exceeded, the defined service life can be expected to be achieved, assuming a switching cycle of 165 minutes on and 15 minutes off. See page 126 for service life details regarding the various electronic ballast families.

Emergency lighting

All Vossloh-Schwabe EBs that are suitable for DC voltage operation can be used in emergency lighting systems. Consideration must, however, be taken of system requirements.

Circuit diagrams for Vossloh-Schwabe electronic ballasts

The circuit diagrams shown here are wiring examples for Vossloh-Schwabe electronic ballasts, whereby the number and configuration of the contacts differ. See the table below for details.

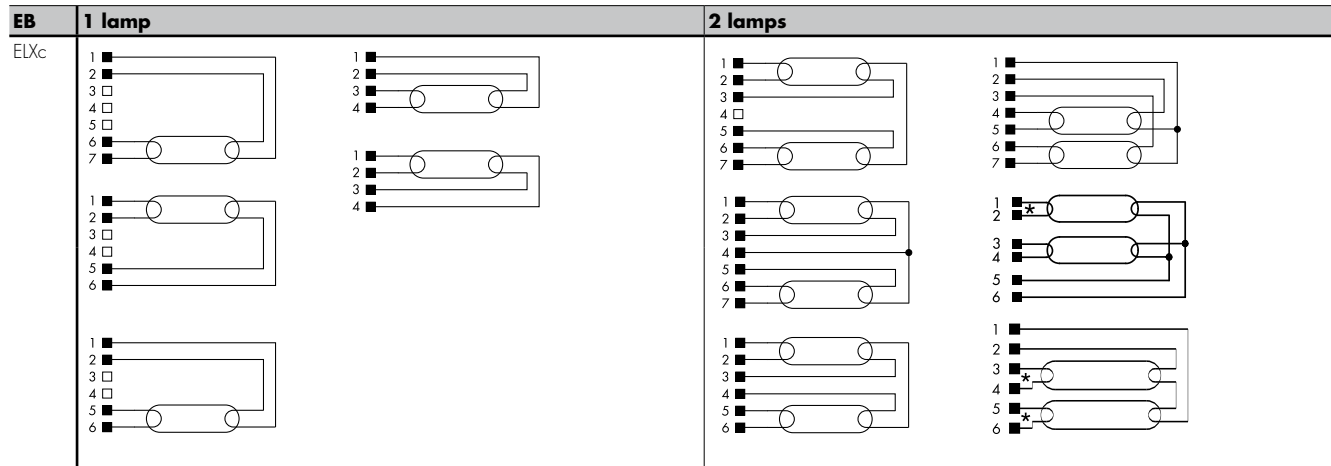

Explanation of circuit diagrams for Vossloh-Schwabe electronic ballasts (see above)

Electronic ballasts		Lamp	Electronic ballasts													Max. lead length		Operation	Output	THD	Possible quantity of EB/automatic cut-outs						
Ref. No.	Type	Quantity	Terminals													hot*	cold	frequency	U _{OUT}	%	B	B	C	C			
			1	2	3	4	5	6	7	8	9	10	11	12	13	14	15	(m/pf)	(m/pf)	kHz	V		(10A)	(16A)	(10A)	(16A)	
ELXc																											
188095	ELXc 149.858	1	x*	x*	x	x	-	-	-	-	-	-	-	-	-	-	-	1/100	2/200	28	330	< 10	11	18	18	30	
188140	ELXc 140.862	1	x*	x*	x	x	-	-	-	-	-	-	-	-	-	-	-	1/100	2/200	45	250	< 10	11	18	18	30	
188142	ELXc 154.864	1	x*	x*	x	x	-	-	-	-	-	-	-	-	-	-	-	1/100	2/200	34	300	< 10	9	15	15	25	
188144	ELXc 180.866	1	x*	x*	x	x	-	-	-	-	-	-	-	-	-	-	-	1/100	2/200	45	300	< 10	9	15	15	25	
188616	ELXc 240.863	2	x*	x*	x	-	x	x	x	-	-	-	-	-	-	-	-	1/100	2/200	46	360	< 15	7	12	12	20	
188617	ELXc 249.859	2	x*	x*	x	x	x	x*	x*	-	-	-	-	-	-	-	-	1/100	2/200	43	480	< 10	7	12	12	20	
188618	ELXc 254.865	2	x*	x*	x	-	x	x	x	-	-	-	-	-	-	-	-	1/100	2/200	43	390	< 10	7	12	12	20	
188619	ELXc 280.538	2	x*	x*	x	x	x	x*	x*	-	-	-	-	-	-	-	-	1/100	2/200	50	420	< 10	-	10	-	10	
188704	ELXc 136.207	1	x	x	-	-	x*	x*	-	-	-	-	-	-	-	-	-	-	-	48	350	< 20	11	18	18	30	
188705	ELXc 236.208	2	x	x	x	x	x*	x*	-	-	-	-	-	-	-	-	-	-	-	45	250	< 20	11	18	18	30	
188707	ELXc 258.210	2	x	x	x	x	x*	x*	-	-	-	-	-	-	-	-	-	-	-	48	350	< 20	7	12	12	19	
188921	ELXc 135.220	1	x*	x*	x	x	-	-	-	-	-	-	-	-	-	-	-	1/100	2/150	41	300	< 10	11	18	18	30	
188922	ELXc 235.221	2	x	x	x	x	x	x*	x*	-	-	-	-	-	-	-	-	1/100	2/150	41	300	< 10	11	18	18	30	

Electromagnetic ballasts

Electromagnetic (inductive) ballasts are active components that in conjunction with starters preheat the lamp electrodes, supply the ignition voltage and stabilise lamp currents during operation. Series or parallel capacitors are required to compensate blind current.

For installation in luminaires, consideration must be taken of the mains voltage and mains frequency, the dimensions and maximum thermal values as well as any potential noise generation. To fulfil these special requirements, Vossloh-Schwabe provides a large variety of different ballasts.

VS magnetic ballasts have been optimised with regard to their magnetic fields and loads so that usually so that noise cannot usually be perceived. However, the luminaire design can cause magnetic vibrations to affect large areas. When designing luminaires, it might therefore be necessary to fit a concertina section or grooves to prevent vibrations from spreading and thus from noise being generated.

The service life of an inductive ballast is mainly determined by the material chosen for the winding insulation. The maximum winding temperature denotes the temperature (tw) that the insulation will withstand for a period of 10 years given continuous operation under rated conditions. This maximum winding temperature must not be exceeded in real conditions to ensure the ballast can achieve its full service life. The winding temperature of the ballast that is measured in the luminaire is made up of the ambient temperature of the luminaire, the thermal conditions within the luminaire and the power loss of the ballast. The Δt marking on the ballast type plate provides a measure of the power loss of the ballast. In addition to this, the power loss of ballast-lamp circuits is measured in accordance with EN 50294. This test method forms the basis for the CELMA energy classification of ballasts and is also applied in European Regulation 245/2009/EG "Definition of eco-design requirements regarding fluorescent lamps without an integrated ballast, high-pressure discharge lamps as well as ballasts and luminaires in their operation and the invalidation of Directive 2000/55/EC" (see pages 142–143 for further details).

As a result of their design features, inductive ballasts cause leak current that is discharged via the earth conductor of the luminaire. The maximum permissible leak current for protection class I luminaires is 1 mA, a value of which all Vossloh-Schwabe electronic ballasts fall clearly short. Values of max. 0.1 mA are measured per electromagnetic ballast. However, as these values accumulate with the number of installed ballasts, this should be taken into account when dimensioning the F1 protective switch.

Starters for fluorescent lamps

As mentioned above, the operation of fluorescent lamps also requires starters in addition to ballasts. A distinction is made between glow starters, which are also available with automatic cut-outs, and electronic starters. The correct choice of voltage and power range is crucial. Starters are available for 220–240 V and for 110–127 V mains voltage. The latter are also required for twin-lamp operation (e.g. 2x18 W at 230 V).

Assembly Instructions for Electromagnetic Ballasts

For mounting and installing of electromagnetic ballasts for fluorescent lamps

Mandatory regulations

DIN VDE 0100	Erection of low voltage installations
EN 60598-1	Luminaires – part 1: general requirements and tests
EN 61347-1	Operating devices for lamps – part 1: general and safety requirements
EN 61347-2-8	Operating devices for lamps – part 2-8: special requirements for ballasts for fluorescent lamps
EN 60921	Ballasts for fluorescent tube lamps – performance requirements
EN 50294	Methods for measuring the total input power of ballast-lamp circuits
EN 55015	Maximum values and methods of measurement for RFI suppression in electrical lighting installations and similar electrical appliances
EN 61000-3-2	Electromagnetic Compatibility (EMC) – part 3: maximum values – main section part 2: maximum values for mains harmonics (device input current up to and including 16 A per conductor)
EN 61547	Installations for general lighting purposes – EMC immunity requirements

Technical specifications

Operating voltage range	VS ballasts can be operated at the specified mains voltage within a tolerance range of $\pm 10\%$
Leak current	≤ 0.1 mA per ballast
Error current	Impulse-resistant leak-current protection must be installed. Distribute the luminaires to phases L1, L2 and L3; install tri-phase FI switches. If permissible, install FI switches with 30 mA leak current; connect no more than 15 luminaires as FI switches can be triggered at half the leak current value.
Power factor	Inductive ballasts: $\lambda \geq 0.5$ Parallel-compensated ballasts: $\lambda \geq 0.85$
Compensation	VS recommends the use of parallel capacitors owing to their technical advantages and power balance.
Possible interference with IR systems	Are not known to occur

1

2

3

4

5

6

7

8

9

10

Mechanical mounting

Mounting position

Any

Mounting location

Ballasts are designed for installation in luminaires or comparable devices. Independent ballasts do not need to be installed in a casing.

Fastening

Preferably using screws \varnothing 4 mm

Maximum temperatures

The stipulated winding temperature (tw 130, tw 140 and tw 150, respectively) must not be exceeded during normal operation. The corresponding maximum values (232 °C, 248 °C and 264 °C, respectively) must be observed during anomalous operation. These values must be checked by measuring resistance during operation.

Temperature increase

The lamp current flowing through the ballast generates a power loss that leads to an increase in winding temperature. The Δt values for normal and abnormal operation provide a measure of this temperature increase. The Δt values are ascertained using standardised connections for measurement and are provided on the ballast type plate in Kelvin.

Example: $\Delta t = 55 \text{ K}/140 \text{ K}$:

The first Δt value indicates the temperature increase for normal operation at the lamp's operating current. The second value, 140 K in this case, denotes the temperature increase of the winding that results from the current that flows when the lamp's discharge path is short-circuited. The current that flows in this state is the preheat current through the lamp's electrodes.

Electromagnetic compatibility (EMC)

Interference

Interference voltage measurements have to be taken at the connection terminals for luminaires with magnetic ballasts as these are systems that operate with lamp voltages of under 100 Hz. These low-frequency interference voltages are generally not critical with magnetic ballasts.

Interference immunity

Thanks to the robust design and choice of materials, magnetic ballasts provide a high degree of interference immunity and are not impaired by admissible mains power interference.

Mains Harmonics

After every zero crossing of the lamp current, fluorescent lamps experience a re-ignition peak as the lamps go out for a brief (imperceptible) moment. These re-ignition peaks generate mains harmonics that are smoothed by the ballast's impedance. The right design, i.e. determining the operating point of the magnetic ballast, ensures mains harmonics are limited to the maximum values permitted by EN 61000-3-2. VS electromagnetic ballasts all comply with the stipulated maximum values.

Selection of automatic cut-outs for VS electromagnetic ballasts

Dimensioning automatic cut-outs

When a ballast is switched on, high transient current peaks occur due to parasite capacitances that can accumulate with the number of luminaires. These high system switch-on currents put a strain on the automatic conductor cut-outs. For this reason, only surge-current-proof automatic cut-outs should be used for lighting systems.

Release reaction The release reaction of the automatic conductor cut-outs comply with VDE 0641, part 11, for B and C characteristics.

No. of ballasts The following values are meant as guidelines only and may vary depending on the respective lighting system. The maximum number of VS ballasts applies to cases where the devices are switched on simultaneously. Specifications apply to single-pole fuses. The number of permissible ballasts must be reduced by 20% for multi-pole fuses. The considered circuit impedance equals 400 mΩ (approx. 20 m of [2.5 m²] conductor from the power supply to the distributor and a further 15 m to the luminaire). Doubling circuit impedance to 800 mΩ increases the possible number of ballasts by 10%. The values quoted in the following tables are guidelines and can be affected by systemspecific factors.

Possible number of ballasts connected to automatic cut-outs for compact fluorescent lamps (single lamp operation)

Lamp output W	10 A (B)		16 A (B)	
	Inductive	Parallel compensation	Inductive	Parallel compensation
5/7/8/9/10/11/13	50	90	80	130
18 (TC-L)	27	32	43	51
18 (TC-D)	40	65	65	110
24	25	32	40	51
26	27	32	43	51
36	23	32	37	51

Possible number of ballasts connected to automatic cut-outs for tubular and U-shaped fluorescent lamps (single lamp operation)

Lamp output W	10 A (B)		16 A (B)	
	Inductive	Parallel compensation	Inductive	Parallel compensation
4/6/8/10	50	90	80	130
13	45	80	70	115
15/18/20	27	32	43	51
30/36/38/40	23	32	37	51
58/65	15	20	22	32
70	13	18	20	30

1

2

3

4

5

6

7

8

9

10

Reliability and service life

Provided the specified maximum values for the winding temperature are complied with, a service life of 10 years can be expected. Failure rate: $\leq 0.025\%/1,000$ hours.

Electrical installation

Connection terminals (combination terminals)

- Use copper (not stranded) wire
- Required diameter for push-in connection 0.5–1 mm²
- Stripped lead length 8 mm
- Required cross-section for IDC zone 0.5 mm²; max. \varnothing 2 mm including insulation, no wire stripping required; mounting requires a special tool

Push-in terminals The integrated terminals can only be used with rigid leads.
Rigid leads: 0.5–1.5 mm². The stripped lead length totals 8 mm.

Wiring The wiring between the mains, ballasts and lamps must comply with the respective circuit diagram.

Circuit diagrams for the operation of fluorescent lamps with Vossloh-Schwabe electromagnetic ballasts

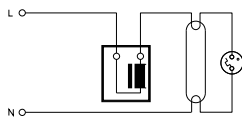

Inductive single circuit

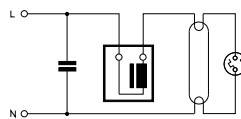

Parallel-compensated single circuit

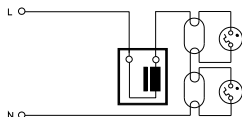

Inductive tandem circuit

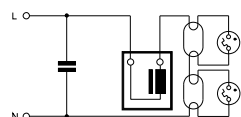

Parallel-compensated tandem circuit

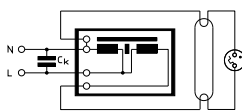

Parallel-compensated single circuit with high-reactance transformer

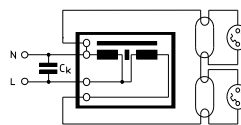

Parallel-compensated tandem circuit with high-reactance transformer

Connection terminals

In the interest of ensuring firm contacts and long component service life, Vossloh-Schwabe uses only top-quality materials for plastic or metal parts during the production of connection terminals. These quality features apply to both Vossloh-Schwabe's luminaire connection terminals as well as to the terminals fitted to ballasts and lampholders.

Notes on connection terminals on electronic ballasts

Vossloh-Schwabe electronic ballasts are fitted with installation-friendly push-in connectors. In addition, many models for linear fluorescent lamps are also available with IDC terminals (for solid conductors 0.5 mm²) and supplementary push-in terminals (for solid conductors 0.5–1 mm²), stripped length 8–9 mm. IDC terminals permit automated luminaire wiring and testing using the ALF system and are thus particularly efficient.

Notes on connection terminals on electromagnetic ballasts

Standard issue Vossloh-Schwabe electromagnetic ballasts are fitted with installation-friendly push-in terminals. The terminals are designed for use with solid conductors with cross-sections of 0.5–1.5 mm² and are approved for current loads of up to 16 A. The lead stripping length totals 7–9 mm for push-in terminals. On request, many ballasts can also be provided with screw terminals (current load up to 16 A) for conductor cross-sections of 0.5 to 2.5 mm².

Notes on connection terminals on lampholders

Vossloh-Schwabe usually equips lampholders for T and TC lamps as well as starter lampholders with installation-friendly push-in terminals for solid conductors of 0.5–1 mm². Most lampholders are fitted with twin push-in terminals and thus permit through-wiring. The required lead stripping length amounts to 8–9 mm for all types.

IDC terminals

In order to fully exploit the vast potential for rationalisation offered by automated wiring and testing, a totally new component family was developed that is equipped with the VDE-tested IDC terminal technology. This technology has already been used very successfully on a large scale in other branches of industry. This connection technology dispenses with the stripping of conductors that is required for the push-in, screw or crimping methods. The tried-and-tested IDC terminal technology has created the foundation for efficient automation as it ensures both high connection quality and rapid contacting. Components equipped in this fashion make it possible to through-wire several terminals with a single conductor. This constitutes a further economic advantage as it significantly reduces the required conductor lengths. Furthermore, this design principle makes it possible to use adapters to simply and reliably make electrical contact from above for a VDE-compatible final luminaire inspection.

ALF connection

Height: 12 mm

Release by twisting and pulling the conductor at the same time

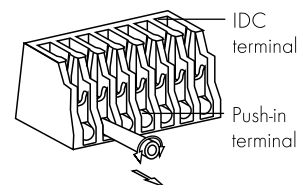

1. Insert release tool above the conductor
2. Pull out the conductor

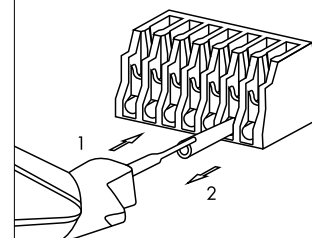

Stripping the conductor for push-in terminal 0.5–1 mm²: 8–9 mm

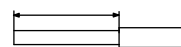

IDC/ Push-in terminal for electromagnetic ballasts

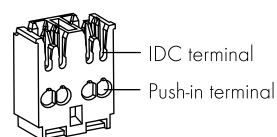

Stripping the conductor for push-in terminal 0.5–1 mm²: 7–9 mm

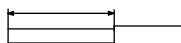

1

2

3

4

5

6

7

8

9

10

Lampholders for Fluorescent Lamps

Lampholders for compact fluorescent lamps

Vossloh-Schwabe produces the majority of lampholders for TC lamps using PBT, a thermoplastic material. This highly heat-resistant material is responsible for the T140 temperature rating. Leading lamp manufacturers also use PBT for the lamp bases they produce. This material harmonisation in conjunction with fatigue-free, stainless steel lamp mounting springs ensures a permanently secure lamp fit.

Lampholders for double-ended fluorescent lamps

VS lampholders for T lamps are characterised by a number of technical features that guarantee a high degree of reliability and safety. The heat-resistant PBT rotor with which most VS lampholders are fitted is a recognised trademark. In addition to the lampholders with the field-tested large rotor, VS also provides a generation of lampholders featuring innovative "Rotoclic" rotor technology. This VS technology constitutes a further milestone in the development of highly heat-resistant rotor systems.

Among the special features of this technology is a T140 temperature rating thanks to a front plate made entirely of PBT as well as a clearly audible click when the lamp is inserted or replaced. As a result, the motion of turning the lamp from "replacement" to "operating" position is aided acoustically.

In addition to this, VS produces a further series of lampholders with a rotor-like function, whose front plates are also made of highly heat-resistant PBT and have similarly been given a T140 temperature rating. The maximum permissible temperature at the back of all lampholders is T_m 110 °C. Another key feature common to all VS lampholders is a highly effective support for the lamp pin that reliably prevents any base pin deflection, even with older lamps, and guarantees a durable and firm contact.

Push-through lampholders

Push-through lampholders are inserted from below through a cut-out in the luminaire casing and are secured by lateral catches. This type of lampholder is frequently used in luminaires on which the lampholder remains visible from the outside, e.g. in so-called strip lighting. The electrical leads are laid beneath the sheet metal level. Luminaire directive EN 60598-1 Para. 8.2 must be observed with regard to the luminaire.

Push-fit lampholders

This lampholder type, which is frequently found in surface-mounted ceiling and built-in luminaires, is pushed into the luminaire casing from above. The lampholder foot should protrude by no more than 4 mm to match the usual height of the spacing cams in the luminaire casing. These lampholders are mostly wired above the luminaire casing to the side of the lampholder. However, there are also lampholders on which the wiring runs through the lampholder foot, with the leads laid beneath the luminaire casing.

Built-in lampholders

This design is also predominantly used for recessed ceiling and surface-mounted luminaires. However, unlike push-fit lampholders, built-in lampholders are usually fitted at the ends of the luminaire boxes. In addition to the usual fixing with split pins attached to the rear, there are also countless versions with fixing clips, push-fit studs or screw-in holes, which are also available with spring-loaded length compensation. Built-in lampholders offer luminaire designers a wealth of scope regarding the choice of lamp position in relation to the reflector. This enables great variation in light distribution as the lampholder does not dictate the distance of the centre of the lamp from the metal casing.







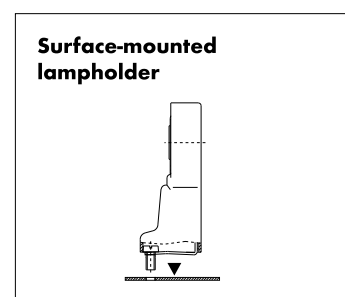
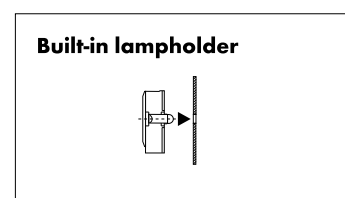
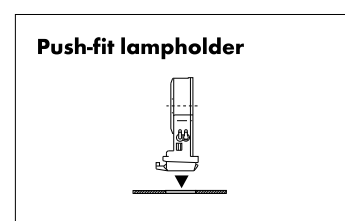
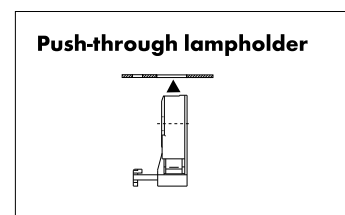
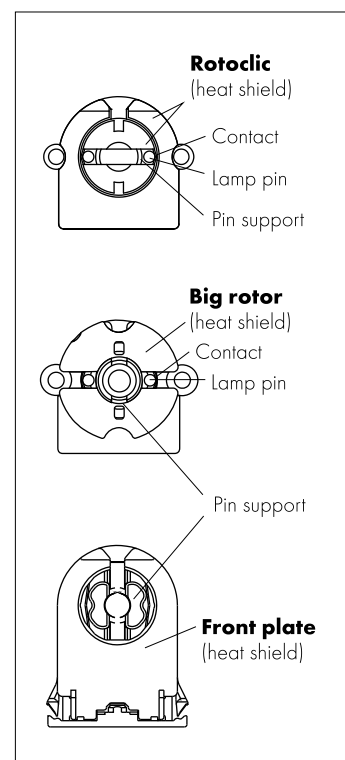



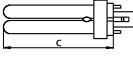

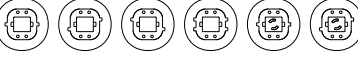
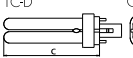
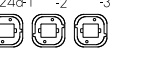

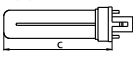



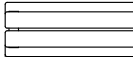

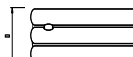
Surface-mounted lampholders

The fastening system of surface-mounted lampholders usually consists of screws or rivets above a fixing level, along which the wiring is also laid. As this type of installation is usually too costly nowadays for large unit numbers, these lampholders are used almost exclusively for special applications, e.g. displays or illuminated advertisements.

VS lampholders for the UL market and UL approved leads are available for all common lamp types. Further information can be found at www.unvlt.com/products/legacy/lampholders.

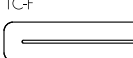

Lamp Table – Fluorescent Lamps

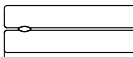
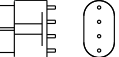
Lamp type/lamp base	Base	Output (W)	Max. length (C) acc. to IEC			
TC-DEL  G24q-1 -2 -3 	G24q-1	10 13	95 130			
	G24q-2	18	140			
	G24q-3	26	160			
TC-TEL  GX24q-1 -2 -3 -4 -5 -6 	GX24q-1	13	90			
	GX24q-2	18	110			
	GX24q-3	26	130			
		32	145			
	GX24q-4	42	155			
	GX24q-5	57	191			
TC-D  G24d-1 -2 -3 	G24d-1	8	73*			
		10	95			
		13	130			
TC-T  GX24d-1 -2 -3 	GX24d-1	13	90			
		18	110			
		26	130			
TC-S  G23 	G23	5	85			
		7	115			
		9	145			
		11	215			
TC-SEL  2G7 	2G7	5	85			
		7	115			
		9	145			
		11	215			
TC-TEL  2G8-1 	2G8-1	60	167			
		85	208			
		120	285			
TC-TEL  GR14q-1 	GR14q-1	14	A	B	C	D
		17	99.7	120	126.6	41*
TC-DD  GR8  GR10q  GRY10q-3  GRZ10d  GRZ10t 	GR8	16	A			
		28	B			
	GR10q	10	92			
		16	138			
		21	141			
		28	138			
		38	205			
	GRY10q-3	55	205			
GRZ10d	18	137				
GRZ10t	30	202				
TC-F  2G10 	2G10	18	122			
		24	165			
		36	217			
TC-L  2G11 	2G11	18	225			
		24	320			
		34	533*			
		36	415			
		40	535			
		55	535			
		80	565			

*not included in IEC standard (non-committal specifications)

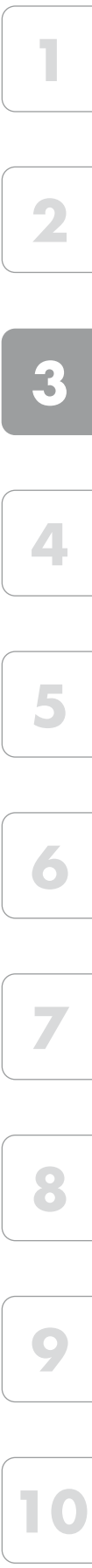

Lamp Table – Fluorescent Lamps

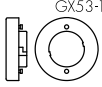
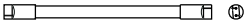
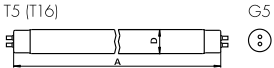
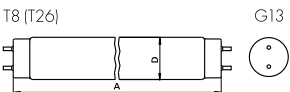
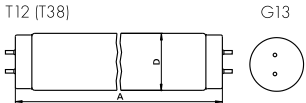
Lamp type/lamp base	Base	Output (W)	Ø D (mm)	Length A/C (mm) acc. to IEC 60081/60901 (for circular lamps B)
	GX53-1	7 9		
	W4.3x8.5d	6 8 11 13	7 7 7 7	219.3 320.9 422.5 524.1
	G5	4 6 8 13 14 20 21 24 25 28 32 34 35 39 45 49 50 54 73 80	16 16 16 16 16 16 16 16 16 16 16 16 16 16 16 16 16 16 16 16	135.9 212.1 288.3 516.9 549.0 549.0 849.0 549.0 1149.0 1149.0 1449.0 849.0 1449.0 849.0 1449.0 1449.0 1449.0 1149.0 1449.0 1449.0
	G13	10 14 15 16 16 18 20*1 23 30 32 33 34 36 36 38 50 51 58 70	26 26 26 26 26 26 26 26 26 26 26 26 26 26 26 26 26 26 26 26	470.0*2 360.0*2 437.4 589.8 720.0*2 589.8 438.0*2 970.0*2 894.6 1199.4 1149.0 1047.0*2 1199.4 970.0*2 1047.0 1500.0 1500.0 1500.0 1763.8
	G13	20 25 30 40 65 75 80*1 85 85*1 100 100*1 115 125 140 140*1 160*1	38 38 38 38 38 38 38 38 38 38 38 38 38 38 38 38 38	589.8 970.0 894.6 1199.4 1500.0 1763.8 1500.0 2374.3 1763.8 2374.3 1800.0*2 1200.0*2 2374.3 1500.0*2 1800.0*2 1800.0*2

*1 UV solarium lamps

*2 Not included in IEC standard
(non-committal specifications)

Lamp Table – Fluorescent Lamps

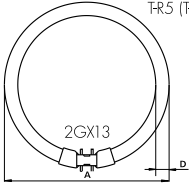
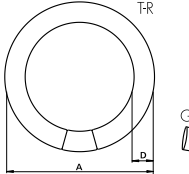
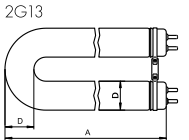
Lamp type/lamp base	Base	Output (W)	Ø D (mm)	A (mm)
 <p>TR5 (FR16)</p>	2GX13	22 40 55 60	16 16 16 16	230.0 305.0 305.0 379.0
 <p>TR</p>	G10q	22 32 40 60	29 29 29 30	215.9 304.8 406.4 408.8*
 <p>2G13</p>	2G13-92	18 36 58	26 26 26	304* 566, 601* 566, 759*

* Not yet included in IEC standard (non-committal specifications)

Tube lengths of plastic and glass protective tube

Ø D (mm)	Length L (mm)
38 ^{+0.5}	L = A-20 ^{±1}
50 ^{+0.8}	L = A-30 ^{±1}

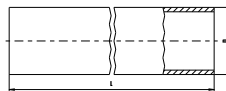

Key to lamp designations

TC-S	Tube Compact-Single
TC-SEL	Tube Compact-Single Electronic
TC-D	Tube Compact-Double
TC-DEL	Tube Compact-Double Electronic
TC-T	Tube Compact-Triple
TC-TEL	Tube Compact-Triple Electronic
TC-Q	Tube Compact-Quad
TC-QEL	Tube Compact-Quad Electronic
TC-DD	Tube Compact-Double D-Shape
TC-L	Tube Compact-Long
TC-F	Tube Compact-Flat
T2 (T7)	Tube Ø 2/8" (7 mm)
T5 (T16)	Tube Ø 5/8" (16 mm)
T8 (T26)	Tube Ø 8/8" (26 mm)
T12 (T38)	Tube Ø 12/8" (38 mm)
T-U	Tube, U-Shape
T-R	Tube, Ring-Shape
T-R5 (T-R16)	Tube, Ring-Shape Ø 5/8" (16 mm)

Energy efficiency classification

Based on Directive 2009/125/EC, the European Commission has revised and redefined the limit values from Regulations (EC) 244/2009, (EC) 245/2009 and (EU) 1194/2012 in the third stage with Regulation (EU) 2019/2020 laying down ecodesign requirements for light sources and separate control gear. This regulation will enter into force on 1 September 2021. In the process, the scope was extended to LED light sources and separate control gear of any kind. In addition, limit values for losses in the so-called standby mode, no-load mode and the standby mode in network operation were added. The energy classes for separate control gears are no longer applicable and the limit values of the former class A2 apply. This means that within the EU, only control gears of energy class A2 and better are permitted.

Furthermore, regulation (EU) 2019/2020 sets higher efficiency requirements for the most common T8 lamps from 1 September 2023, which de facto prohibits the placing of T8 lamps on the EU market.

The following table summarises the minimum energy efficiencies based on the energy classifications of ballasts valid until 1.9.2021. From 1.9.2021, classes A3 to B2 will be banned in the EU and the only minimum energy efficiency requirement will be the values of class A2, which are highlighted in the following table.

Lamp data					Ballast efficiency (PLS/P _{Input}) (non-dimmable ballasts)				
Type	Nominal output W	ILCOS-Code	Typical rating		A2 BAT %	A2 %	A3 %	B1 %	B2 %
			50 Hz W	HF W					
T8	15	FD-15-E-G13-26/450	15	13.5	87.8	84.4	75.0	67.9	62.0
	18	FD-18-E-G13-26/600	18	16	87.7	84.2	76.2	71.3	65.8
	30	FD-30-E-G13-26/900	30	24	82.1	77.4	72.7	79.2	75.0
	36	FD-36-E-G13-26/1200	36	32	91.4	88.9	84.2	83.4	79.5
	38	FD-38-E-G13-26/1050	38.5	32	87.7	84.2	80.0	84.1	80.4
	58	FD-58-E-G13-26/1500	58	50	93.0	90.9	84.7	86.1	82.2
	70	FD-70-E-G13-26/1800	69.5	60	90.9	88.2	83.3	86.3	83.1
TC-L	18	FSD-18-E-2G11	18	16	87.7	84.2	76.2	71.3	65.8
	24	FSD-24-E-2G11	24	22	90.7	88.0	81.5	76.0	71.3
	36	FSD-36-E-2G11	36	32	91.4	88.9	84.2	83.4	79.5
TC-F	18	FSS-18-E-2G10	18	16	87.7	84.2	76.2	71.3	65.8
	24	FSS-24-E-2G10	24	22	90.7	88.0	81.5	76.0	71.3
	36	FSS-36-E-2G10	36	32	91.4	88.9	84.2	83.4	79.5
TC-D/ TC-DE	10	FSQ-10-E-G24q=1 FSQ-10+G24d=1	10	9.5	89.4	86.4	73.1	67.9	59.4
	13	FSQ-13-E-G24q=1 FSQ-13+G24d=1	13	12.5	91.7	89.3	78.1	72.6	65.0
	18	FSQ-18-E-G24q=2 FSQ-18+G24d=2	18	16.5	89.8	86.8	78.6	71.3	65.8
	26	FSQ-26-E-G24q=3 FSQ-26+G24d=3	26	24	91.4	88.9	82.8	77.2	72.6
TC-T/ TC-TE	13	FSM-13-E-GX24q=1 FSM-13+GX24d=1	13	12.5	91.7	89.3	78.1	72.6	65.0
	18	FSM-18-E-GX24q=2 FSM-18+GX24d=2	18	16.5	89.8	86.8	78.6	71.3	65.8
	26	FSM-26-E-GX24q=3 FSM-26+GX24d=3	26.5	24	91.4	88.9	82.8	77.5	73.0
TC-DD/ TC-DDE	10	FSS-10-E-GR10q FSS-10-L/P/H-GR10q	10.5	9.5	86.4	82.6	70.4	68.8	60.5
	16	FSS-16-E-GR10q FSS-16+GR10q FSS-10-L/P/H-GR10q	16	15	87.0	83.3	75.0	72.4	66.1
	21	FSS-21-E-GR10q FSS-21+GR10q FSS-21-L/P/H-GR10q	21	19	89.4	86.4	79.2	73.9	68.8
	28	FSS-28-E-GR10q FSS-28+GR10q FSS-28-L/P/L-GR10q	28	26	89.7	86.7	81.3	78.2	73.9
	38	FSS-38-E-GR10q FSS-38-L/P/L-GR10q	38.5	36	92.3	90.0	85.7	84.1	80.4

Lamp types

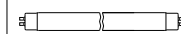

T8

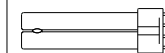

TC-L

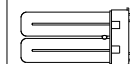

TC-F

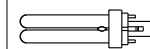

TC-D/TC-DE

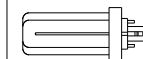

TC-T/TC-TE

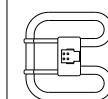

TC-DD/TC-DDE

Lamp data					Ballast efficiency (P_{LS}/P_{Input}) (non-dimmable ballasts)				
Type	Nominal output W	ILCOS-Code	Typical rating		Ballast efficiency (%)				
			50 Hz W	HF W	A2	A3	B1	B2	
TC	5	FSD-5I-G23 FSD-5-E-2G7	5.4	5	72.7	66.7	58.8	49.3	41.4
	7	FSD-7I-G23 FSD-7-E-2G7	7.1	6.5	77.6	72.2	65.0	55.7	47.8
	9	FSD-9I-G23 FSD-9-E-2G7	8.7	8	78.0	72.7	66.7	60.3	52.6
	11	FSD-11I-G23 FSD-11-E-2G7	11.8	11	83.0	78.6	73.3	66.7	59.6
T5	4	FD-4-E-G5-16/150	4.5	3.6	64.9	58.1	50.0	45.0	37.2
	6	FD-6-E-G5-16/225	6	5.4	71.3	65.1	58.1	51.8	43.8
	8	FD-8-E-G5-16/300	7.1	7.5	69.9	63.6	58.6	48.9	42.7
	13	FD-13-E-G5-16/525	13	12.8	84.2	80.0	75.3	72.6	65.0
T9-C	22	FSC-22-E-G10q-29/200	22	19	89.4	86.4	79.2	74.6	69.7
	32	FSC-32-E-G10q-29/300	32	30	88.9	85.7	81.1	80.0	76.0
	40	FSC-40-E-G10q-29/400	40	32	89.5	86.5	82.1	82.6	79.2
T2	6	FDH-6-L/P-W4.3x8.5d7/220		5	72.7	66.7	58.8	—	—
	8	FDH-8-L/P-W4.3x8.5d7/320		7.8	76.5	70.9	65.0	—	—
	11	FDH-11-L/P-W4.3x8.5d7/420		10.8	81.8	77.1	72.0	—	—
	13	FDH-13-L/P-W4.3x8.5d7/520		13.3	84.7	80.6	76.0	—	—
	21	FDH-21-L/P-W4.3x8.5d7		21	88.9	85.7	79.2	—	—
	23	FDH-23-L/P-W4.3x8.5d7		23	89.8	86.8	80.7	—	—
T5-E	14	FDH-14-L/P-G5-16/550		13.7	84.7	80.6	72.1	—	—
	21	FDH-21-L/P-G5-16/850		20.7	89.3	86.3	79.6	—	—
	24	FDH-24-L/P-G5-16/550		22.5	89.6	86.5	80.4	—	—
	28	FDH-28-L/P-G5-16/1150		27.8	89.8	86.9	81.8	—	—
	35	FDH-35-L/P-G5-16/1450		34.7	91.5	89.0	82.6	—	—
	39	FDH-39-L/P-G5-16/850		38	91.0	88.4	82.6	—	—
	49	FDH-49-L/P-G5-16/1450		49.3	91.6	89.2	84.6	—	—
	54	FDH-54-L/P-G5-16/1150		53.8	92.0	89.7	85.4	—	—
	80	FDH-80-L/P-G5-16/1150		80	93.0	90.9	87.0	—	—
	95	FDH-95-L/P-G5-16/1150		95	92.7	90.5	84.1	—	—
	120	FDH-120-L/P-G5-16/1450		120	92.5	90.2	84.5	—	—
T5-C	22	FSCH-22-L/P-2GX13-16/225		22.3	88.1	84.8	78.8	—	—
	40	FSCH-40-L/P-2GX13-16/300		39.9	91.4	88.9	83.3	—	—
	55	FSCH-55-L/P-2GX13-16/300		55	92.4	90.2	84.6	—	—
	60	FSCH-60-L/P-2GX13-16/375		60	93.0	90.9	85.7	—	—
TC-LE	40	FSDH-40-L/P-2G11		40	91.4	88.9	83.3	—	—
	55	FSDH-55-L/P-2G11		55	92.4	90.2	84.6	—	—
	80	FSDH-80-L/P-2G11		80	93.0	90.9	87.0	—	—
TC-TE	32	FSMH-32-L/P-GX24q=3		32	91.4	88.9	82.1	—	—
	42	FSMH-42-L/P-GX24q=4		43	93.5	91.5	86.0	—	—
	57	FSM6H-57-L/P-GX24q=5 FSM8H-57-L/P-GX24q=5		56	91.4	88.9	83.6	—	—
	70	FSM6H-70-L/P-GX24q=6 FSM8H-70-L/P-GX24q=6		70	93.0	90.9	85.4	—	—
	60	FSM6H-60-L/P-2G8=1		63	92.3	90.0	84.0	—	—
	62	FSM8H-62-L/P-2G8=2		62	92.2	89.9	83.8	—	—
	82	FSM8H-82-L/P-2G8=2		82	92.4	90.1	83.7	—	—
	85	FSM6H-85-L/P-2G8=1		87	92.8	90.6	84.5	—	—
	120	FSM6H-120-L/P-2G8=1 FSM8H-120-L/P-2G8=1		122	92.6	90.4	84.7	—	—
TC-DD	55	FSSH-55-L/PGR10q		55	92.4	90.2	84.6	—	—

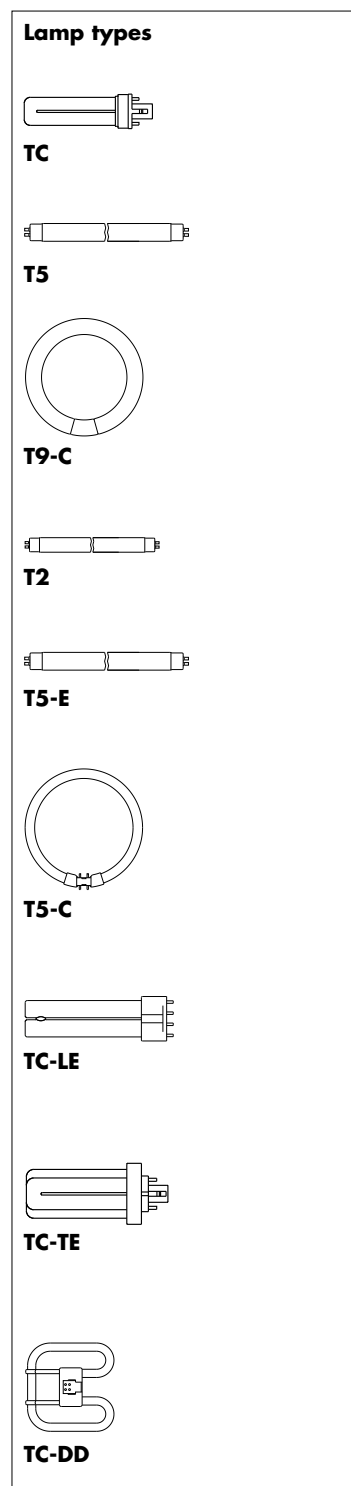

With the Ecodesign Regulation (EU) 2019/2020, the minimum energy efficiency values of the 3rd stage from 2017 corresponding to class A2 are prescribed, which are calculated as follows:

$$\begin{aligned}
 &\text{If } P_{LS} \leq 5 \text{ W} && \eta_{\min.} = 0.71 \\
 &\text{If } 5 \text{ W} < P_{LS} \leq 100 \text{ W} && \eta_{\min.} = P_{LS}/[2 \cdot \sqrt{P_{LS}/36} + 38/36 \cdot P_{LS} + 1] \\
 &\text{If } P_{LS} > 100 \text{ W} && \eta_{\min.} = 0.91
 \end{aligned}$$

(P_{LS} = measured light source power)

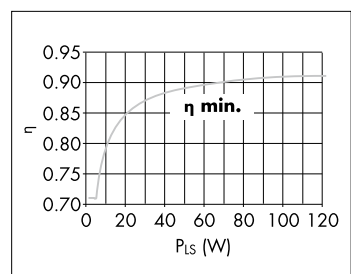

SYSTEM- OPTIMISING COMPENSATION



PARALLEL CAPACITORS

Capacitors are designed to compensate inductive reactive current of discharge lamps in 50/60 Hz networks when operated with electromagnetic ballasts. As required by utility companies, capacitors serve to compensate the reactive current generated by the respective ballast. A power factor of $\lambda \geq 0.9$ is achieved.

In addition, capacitors can also be used to compensate or generate phase displacements. Careful selection of the raw materials as well as special thermal treatment of the capacitor coil guarantee a long service life and stable capacitance.



4

Parallel Capacitors

Parallel capacitors

146–147

Technical details for parallel capacitors

148–155

General technical details

228–236

Glossary

237–239

1

2

3

4

5

6

7

8

9

10

Parallel Connected Capacitors with Leads 250 V, 50/60 Hz

Capacitors type A

Casing: plastics, white

Fastening: male nipple M8x10 with nut and washer included

Discharge resistance

Leads: H05V2U 0,5 mm², length: 250 mm

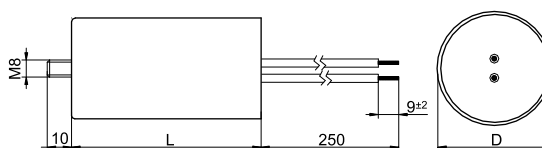

Ref. No.	Capacity μF (±10%)	Temperature range °C	Ø (D) mm	Length (L) mm	Male nipple/ length (mm)	Weight g	Packaging unit pcs.
571653	2.5	-25 to 85	29	50	M8x10	26	400
526169	4.0	-25 to 85	29	50	M8x10	27	400
571654	4.5	-25 to 85	29	50	M8x10	27	400
526170	6.0	-25 to 85	29	50	M8x10	28	400
526171	8.0	-25 to 85	29	50	M8x10	35	400
571655	9.0	-25 to 85	33	63	M8x10	40	250
529665	10.0	-25 to 85	33	63	M8x10	42	250
526172	12.0	-25 to 85	33	63	M8x10	45	250
543402	13.5	-25 to 85	33	63	M8x10	47	250
529666	16.0	-25 to 85	40	63	M8x10	61	150
551644	18.0	-25 to 85	40	63	M8x10	65	150
528552	20.0	-25 to 85	40	63	M8x10	69	150
508484	25.0	-25 to 85	40	63	M8x10	71	150
536743	30.0	-25 to 85	45	88	M8x10	95	130
528554	35.0	-25 to 85	45	88	M8x10	105	130
571656	40.0	-25 to 85	45	88	M8x10	113	130
528555	45.0	-25 to 85	45	88	M8x10	123	130
571657	50.0	-25 to 85	45	88	M8x10	127	130
571658	55.0	-25 to 85	50	94	M8x10	147	90
571659	60.0	-25 to 85	50	94	M8x10	157	90
571660	65.0	-25 to 85	55	94	M8x10	167	80

Parallel Connected Capacitors with Break-action Mechanism

Capacitors type B

- Casing: aluminium
- Filling material: based on vegetable oil
- Fastening: male nipple with nut and washer included
- Discharge resistance
- Overpressure protection
- On request further capacities or connectors



A Push-in twin terminals 0.5–1 mm²

B Double spade connector 6.3x0.8 acc. to IEC 61210

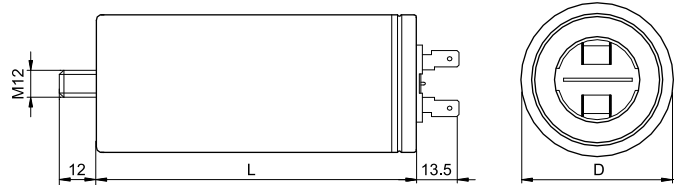
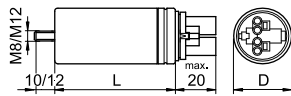

Ref. No.	Capacity µF (±10%)	Temperature range °C	Drawing	Ø (D) mm	Length (L) mm	Male nipple/ length (mm)	Weight g	Packaging unit pcs.
250 V, 50/60 Hz								
536379	4.0	-40 to 100	A	30	60	M8x10	35	250
536380	6.0	-40 to 100	A	30	60	M8x10	40	250
536381	8.0	-40 to 100	A	35	72	M8x10	42	250
536382	10.0	-40 to 100	A	35	72	M8x10	46	250
536383	12.0	-40 to 100	A	35	72	M8x10	49	250
536386	18.0	-40 to 100	A	40	72	M8x10	76	180
536387	20.0	-40 to 100	A	40	72	M8x10	80	180
536388	25.0	-40 to 100	A	40	72	M8x10	82	180
536389	30.0	-40 to 100	A	40	97	M8x10	101	162
536390	32.0	-40 to 100	A	40	97	M8x10	105	162
536392	40.0	-40 to 100	A	45	97	M8x10	132	144
536393	45.0	-40 to 100	A	45	97	M8x10	142	144
536394	50.0	-40 to 100	A	45	97	M8x10	150	144
536396	60.0	-40 to 100	A	45	121	M8x10	175	35
537058	65.0	-40 to 100	B	60	105	M12x12	201	25
506360	85.0	-40 to 100	B	60	130	M12x12	248	25
506363	100.0	-40 to 100	B	60	130	M12x12	286	25

Ref. No.	Capacity µF (±10%)	Temperature range °C	Drawing	Ø (D) mm	Length (L) mm	Male nipple/ length (mm)	Weight g	Packaging unit pcs.
450 V, 50/60 Hz								
536400	32.0	-40 to 100	A	45	97	M8x10	179	144
536401	37.0	-40 to 100	A	45	121	M8x10	200	35
536402	50.0	-40 to 100	B	55	130	M12x12	360	30
536404	60.0	-40 to 100	B	55	130	M12x12	270	30
536405	85.0	-40 to 100	B	60	130	M12x12	420	25

4

Capacitors for Fluorescent and Discharge Lamps

Idle current compensation	149
Parallel compensation	150
MPP capacitor technology	150-152
Assembly instructions - Capacitors	152-154
Capacitor tables	154-155
General technical details	228-236
Glossary	237-239

Compensation of idle current

When using magnetic ballasts a phase shift occurs between the mains voltage and the current drawn. This phase shift is expressed by the power factor λ , which generally ranges between a value of 0.3 and 0.7 with inductive circuits.

As a result of this phase shift, idle current, which does not boost the efficiency of the lighting unit, is also taken up from the power supply network in addition to real power. Power utility companies therefore require an increase of the power factor to values of over 0.85 for systems exceeding a certain rating (usually upwards of 250 W per external conductor).

Compensation capacitors are used to counteract idle current (by increasing the power factor) and can be connected either in parallel or in series.

Thanks to a power factor of approx. 0.95, electronic ballasts do not need to be operated with compensation capacitors.

Compensation using series capacitors

Series compensation employs a so-called dual circuit (two fluorescent lamp circuits connected in parallel), whereby the capacitor, which is connected in a branch of the circuit, over compensates the inductive idle current to such an extent that it covers the idle current of both ballasts. This type of circuit is only used with fluorescent lamps. As series capacitors are dimensioned for nominal-voltage and ballast tolerances, the lamp in the capacitor branch of the dual circuit operates with a higher current and thus also with a higher rating. Apart from differences in lamp brightness, the power loss in the circuit branch with the capacitor will also be greater.

An advantage of the dual circuit is that it prevents the radiated light from flickering.

The higher current in the so-called capacitive lamp circuit causes an up to 14% increase in lamp rating and a reduction of the lamp service life by as much as 20%. This goes hand in hand with substantial technical, ecological and economic disadvantages.

Series capacitors have to meet very high technical requirements to suit various aspects like temperature, nominal voltage, tolerances of the capacitance values, etc.

As defined by EC directive 2000/55/EC (European Standard EN 50294 governing the measurement of total power consumption), a series capacitor is considered to be a part of the ballast. If the system rating of the capacitive circuit containing the lamps and ballasts is then determined in line with the above definition, rating increases of up to 14% will become apparent in comparison to operation without a series capacitor. Experience has shown that this increased power consumption often means devices fall in the directive's "banned" category. It is therefore strongly advised that due consideration be given to the elevated power consumption values common to using series capacitors for compensation purposes.

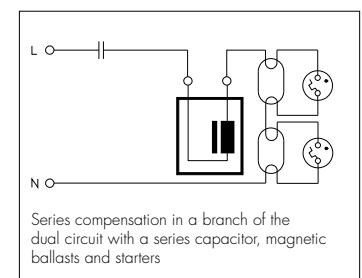

1

2

3

4

5

6

7

8

9

10

Parallel compensation

During parallel compensation, each lamp circuit is assigned to a capacitor connected in parallel to the mains. Only one capacitor providing sufficient capacitance is needed for luminaires with several lamps. Parallel compensation does not affect current flow through a discharge lamp. The requirements placed on parallel capacitors are clearly lower than those for series capacitors.

However, parallel compensation can be subject to limitations when using audio-frequency ripple control pulses if the system operates with a connected rating of over 5 kVA and ripple control frequencies of over 300 Hz are used. The respective power utility company should be consulted for advice in such cases.

Parallel compensation is used in fluorescent lamp and high-pressure discharge lamp circuits.

As parallel compensation offers substantial advantages, this has become the accepted method in the last few years.

Metallised polypropylene film capacitors

Metallised polypropylene film capacitors are designed to compensate the inductive idle current drawn by discharge lamps (fluorescent lamps, high-pressure mercury vapour lamps, high-pressure sodium vapour lamps and metal halide lamps with a ceramic discharge tube) in 50 Hz/60 Hz grids. All Vossloh-Schwabe compensation capacitors for luminaires feature a metallised polypropylene film dielectric. Compensation capacitors help to increase the power factor to values of over λ 0.85 as required by power utility companies.

Construction of metallised polypropylene film capacitors

VS MPP capacitors contain a low-loss metallised polypropylene film dielectric, which is produced by depositing a thin layer of zinc and aluminium or pure aluminium vapour onto one side of the polypropylene film. The contacts at either end of the capacitor coil are created by spraying on a layer of metal and thus guarantee a high current-carrying capacity as well as a low-inductive connection between the terminals and the coils.

All capacitors with a nominal voltage upwards of 280 V are filled with oil or resin after the coils have been inserted and then hermetically sealed. This protects the coils from environmental influences and reduces partial discharge, which contributes to a long service life and stable capacitance. The effects of partial discharge only play a minor role for capacitors with a nominal voltage of under 280 V so that these devices do not need to be filled.

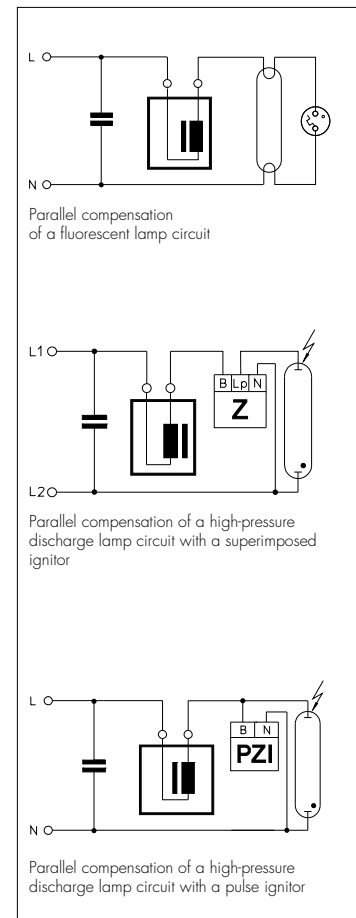

Hermetically sealed, filled capacitors with an overpressure contact breaker should always be used in critical ambient conditions (high humidity, aggressive atmospheres, high temperatures), if the workload and power supply conditions are unknown as well as in situations that demand increased attention to safety.

VS MPP capacitors feature a self-healing dielectric. In the event of a dielectric breakdown in the coil (short circuit), the metal coating vaporises around the breakdown site owing to the high temperature of the transient arc that is produced. Owing to the excess pressure generated during such a breakdown, the metal vapour is pushed outwards away from the centre of the site within the space of just a few microseconds. This creates a coating-free corona around the breakdown site that completely isolates it and means the capacitor remains fully functional during a dielectric breakdown.

The self-healing properties of a capacitor can decrease with time and with constant overloading. This bears the risk of a non-healing breakdown with a permanent short circuit. Therefore self-healing must not be confused with failsafe.

Compensation capacitors are divided into two type families (A and B) in accordance with IEC 61048 A2.

- Type A capacitors defined:
"Self-healing parallel capacitors; without an (overpressure) contact breaker in the event of failure".
They are referred to as unsecured capacitors.
- Type B capacitors defined:
"Self-healing capacitors for series connection in lighting circuits or self-healing parallel capacitors; with an (overpressure) contact breaker in the event of failure".
These are referred to as hermetically sealed, secured capacitors.

In accordance with the standard, the discharge resistor of both capacitor families must be capable of reducing capacitor voltage to a value of under 50 V in the space of 60 seconds after disconnection from the mains.

Capacitors without a contact breaker, unsecured, Type A capacitors in accordance with IEC 61048 A2

IEC 61048 A2-compliant Type A capacitors are self-healing and require no short-circuit protection for normal operation.

Type A capacitors are not fitted with a specific failsafe mechanism as prescribed by the standards for Type B capacitors. Nevertheless, the requirements laid down in the standard for Type A capacitors, especially with regard to temperature and service life tests, are designed to ensure a sufficient degree of device safety and availability **provided the device was correctly installed and operated under calculable and known ambient operating conditions.**

Even so, in very rare cases these capacitors can still develop erratic behaviour due to overloading or at the end of the device's service life.

For that reason, Type A capacitors should only be integrated into luminaires for operation in ambient conditions that are uncritical with regard to flammable materials. Luminaires should feature protection against secondary damage inside and outside the luminaire in the event of a defect.

1

2

3

4

5

6

7

8

9

10

Capacitors with a contact breaker, secured Type B capacitors in accordance with IEC 61048 A2

Self-healing capacitors do not require short-circuit protection for normal operation as they automatically regenerate after a dielectric breakdown. However, as a result of frequent self-healing caused by overloading (voltage, current, temperature) or towards the end of the capacitor's service life, overpressure can build up inside the capacitor (due to the decomposition products of the vaporised polypropylene).

In order to prevent the capacitor casing from exploding in such cases, hermetically sealed capacitors in accordance with IEC 61048 A2 (Type B capacitors) are fitted with an overpressure contact breaker. If excess pressure builds up within these capacitors, e.g. due to undue thermal loading or excessive voltages or at the end of the capacitor's service life, a concertina section opens out that causes the casing to expand lengthways. As a result, the wire contacts rupture at a predetermined breaking point, which irreversibly interrupts the current (contact breaker).

This type of overpressure-protected capacitor with a contact breaker is also referred to as a flame- and explosion-proof capacitor with a break-action mechanism.

Type B capacitors with a contact breaker are available in an aluminium casing.

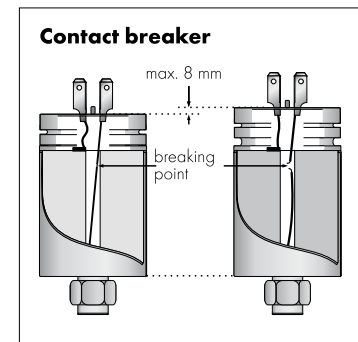

Assembly Instructions for Capacitors

For mounting and installing compensation capacitors

Mandatory regulations

- DIN VDE 0100 Erection of low voltage installations
- EN 60598 Luminaires – part 1: General requirements and tests
- EN 55015 Maximum values and testing methods for radio disturbance of electrical lighting facilities and similar electrical equipment
- EN 61000-3-2 Electromagnetic Compatibility (EMC) – part 3: maximum values – main section part 2: maximum values for mains harmonics (ballast input current up to and including 16 A per conductor)
- EN 61048 Operating devices for lamps – capacitors for fluorescent lamp circuits and other discharge lamp circuits; general and safety requirements
- EN 61049 Operating devices for lamps – capacitors for fluorescent lamp circuits and other discharge lamp circuits; performance requirements

Mechanical mounting

- Fastening Base screw (permissible torque):
- M8x10 – 5 Nm (aluminium casing)
 - M8x10 – 2.2 Nm (plastic casing)

Mounting location

Any

Capacitors fitted with overpressure protection require clearance of at least 10 mm above the contacts so ensure the casing can expand unhindered if the contact breaker is triggered.

Heat transfer	Capacitors should be mounted with the greatest possible clearance to heat sources or lamps. During operation, the temperature measured at the t_c point must not exceed the specified maximum value.
t_c point	The t_c point is defined as an arbitrary point on the surface of the capacitor, which is not specifically marked.
UV Radiation	Capacitors should not be installed in an unprotected manner directly next to any sources of light, heat radiation or convection (ballasts, lamps, heating elements, etc.) as both high temperatures and constant exposure to UV radiation can lead to premature ageing. In combination with high temperatures, UV radiation or other substances and influencing factors, chemicals such as ozone and chlorine can lead to accelerated ageing and material embrittlement.
Thermal load	All capacitor casings are made of flame-retardant materials. However, the potting material, oils and the winding material are flammable and consideration must be taken of this fact during installation. The thermal load of an MKP capacitor is approx. 40 MJ/kg.

Safety functions

Type A capacitors

are not fitted with any special protective functions in case of defect. Temperature-protected capacitors are a further development of Type A capacitors and feature a thermal fuse that is triggered by excess temperatures and disconnects the capacitor from the mains.

Type B capacitors

are fitted with an overpressure contact breaker in case of defects at the end of the capacitor's service life.

Connection

Parallel capacitors for fluorescent lamps:

- Casing diameter 25–30 mm: push-in terminals for 0.5–1 mm² conductors
- Casing diameter > 30 mm: push-in terminals for 0.5–1 mm² conductors

Parallel capacitors for high-pressure lamps:

- Casing diameter 25–30 mm: push-in terminals for 0.5–1 mm² conductors
- Casing diameter > 30 mm: push-in terminals for 0.5–1 mm² conductors

Reliability and service life

Provided the max. specified voltage and current loads, temperature, humidity and mains harmonics values are observed,

- approx. 50,000 hours for overpressure-protected parallel capacitors
- approx. 30,000 hours for parallel capacitors without overpressure protection in a plastic or aluminium casing

A 3–10% decrease in capacitance must be expected in the course of the capacitor's service life.

Failure rate: 1‰ per 1,000 operating hours when maximum voltage, current and temperature values are not exceeded.

1

2

3

4

5

6

7

8

9

10

Technical Details – Capacitors for Fluorescent and Discharge Lamps

Electrical installation

Nominal voltage 250 V, 50/60 Hz; 450 V, 50/60 Hz
(dependent on type)

Capacitance tolerance
±10% (±5% dependent on type)

Temperature range
-25/-40 °C to +85/+100 °C (dependent on type, details see product page)

Optional thermal fuse

Relative humidity Class F for Type B capacitors: 75% annual mean, 95% peak value on 30 days
Class G for Type A capacitors: 65% annual mean, 85% peak value on 30 days

Condensation Impermissible

Capacitors for fluorescent lamp circuits

Lamp		Parallel compensation capacitor (µF ±10% at 250 V)	
Output W	Type	220–240 V/50 Hz µF	220–230 V/60 Hz µF
4	T	2**	2**
6	T	2**	2**
8	T	2**	2**
10	T	2	2
13	T	2	2
14	T	4.5	4.5
15	T	3.5 or 4*	3 or 4*
16	T	2	2
18	T	4.5 or 4*	4**
20	T	4.5 or 4*	4**
23	T	3.5	3
25	T	3.5	3
30	T	4.5	4
36	T	4.5	4
36-lm	T	6.5	—
38	T	4.5	4
40	T	4.5	4
42	T	6.5	—
58	T	7	6
65	T	7	6
70	T	6	—
75	T	6	—
80	T	9	8
85	T	8	6.5
100	T	10	9
115	T	18	16
140	T	14	14
160	T	14	14
16	T-U	2	2
18/20	T-U	4.5 or 4*	4**
36/40	T-U	4.5	4
58/65	T-U	7	6
22	T-R	5	4.5
32	T-R	5	4.5
40	T-R	4.5	4

Lamp		Parallel compensation capacitor ($\mu\text{F} \pm 10\%$ at 250 V)	
Output W	Type	220–240 V/50 Hz μF	220–230 V/60 Hz μF
5/7/9/11	TC-S	2**	2**
10	TC-D/TC-T	2	2
13	TC-D/TC-T	2	2
18	TC-D/TC-T	2	2
26	TC-D/TC-T	3.5	3
10	TC-DD	2	2
16	TC-DD	2	2
21	TC-DD	3	3
28	TC-DD	3.5	3
38	TC-DD	4.5	4
18	TC-L/TC-F	4.5 or 4*	4**
24	TC-L/TC-F	4.5	4
34	TC-L/TC-F	4.5	4
36	TC-L/TC-F	4.5	4

*) Two lamps connected to a ballast in series

***) Applies to one lamp connected to a ballast or two lamps connected in series

Capacitors for discharge lamp circuits

Lamp		Compensation capacitor ($\mu\text{F} \pm 10\%$)			
Output W	Type	220/230/240/252 V 50 Hz (μF)	220 V 60 Hz (μF)	380/400/420 V, 50 Hz (μF)	380 V/60 Hz 60 Hz (μF)

high-pressure mercury vapour lamp circuits

50	HM	7	6		
80	HM	8	7		
125	HM	10	10		
250	HM	18	15		
400	HM	25	25		
700	HM	40	35		
1000	HM	60	50		

high-pressure sodium vapour lamp circuits

35	HS	6	5		
50	HS	8	8		
70	HS	12	10		
100	HS	12	10		
150	HS	20	16		
250	HS	32	25		
400	HS	45	40		
600	HS	65	55	25	20
750	HS	70	60	25	25
1000	HS	100	85		

metal halide lamp circuits

35	HI	6	5		
70	HI	12	10		
100	HI	12	10		
150	HI	20	16		
250	HI	32	25		
400	HI	35/45	35/45		
1000	HI	85	75		
2000	HI	125	125		
2000	HI			37	37
2000	HI			60	60
2000	HI			60	60
2000	HI			100	100

1

2

3

4

5

6

7

8

9

10

ELECTRONIC CONVERTERS

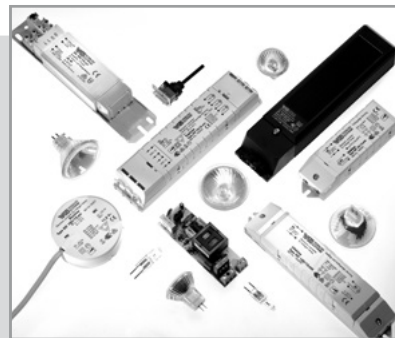

FOR LOW-VOLTAGE HALOGEN INCANDESCENT LAMPS

The operating voltage of low-voltage halogen lamps is normally 12 V (6 and 24 V are also used for special applications). As a result, transformers are required in order to connect such lamps to the normal mains supply within buildings, whereby international requirements governing building installations specify that safety transformers or converters (electronic transformers) be exclusively used for such purposes nowadays. These devices are designed in such a way as to prevent both personal injury and the outbreak of fire should the lighting system malfunction.

Electronic converters

The following chapter provides an overview of the VS range of electronic converters that feature a whole range of advantages: light and compact, superior efficiency (approx. 95%), short-circuit protection, integrated overheating and overload protection, soft start for longer lamp life, broad part-load range and dimmability.



5

Electronic Converters for Low-voltage Halogen Incandescent Lamps

Independent electronic converters

158

Technical details for incandescent lamps

206-215

General technical details

228-236

Glossary

237-239

1

2

3

4

5

6

7

8

9

10

Independent Electronic Converters – LiteLine

Electronic safety converters for low-voltage halogen incandescent lamps 12 V
 Casing: heat-resistant polyamide
 Mains frequency: 50–60 Hz
 Protection against "no load" operation
 Protection against short-circuit:
 electronic switch-off with automatic restart
 Electronically controlled overload and temperature protection
 Suitable for installation in furniture and on combustible surfaces
 Power factor: > 0.95
 Efficiency: ≥ 94%
 Dimming: optional with phase-cutting leading-edge or phase-cutting trailing-edge dimmer
 Screw terminals: 2.5 mm²
 (EST 60/12.635 primary: 4 mm²)
 Quantity of screw terminals:
 1x2-poles primary
 1x2-poles secondary
 With integrated cord grip
Protection class II
 SELV
 Degree of protection: IP20
 RFI-suppressed

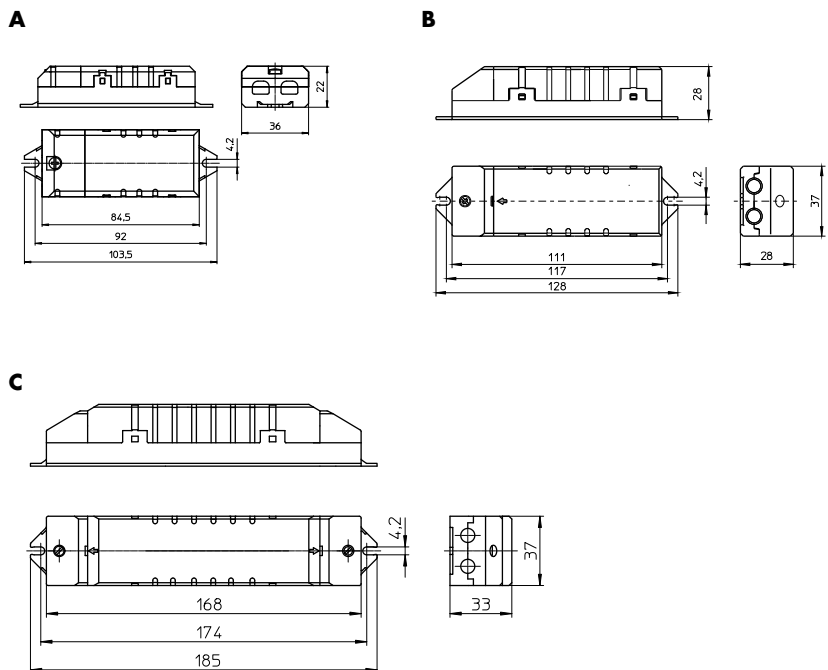
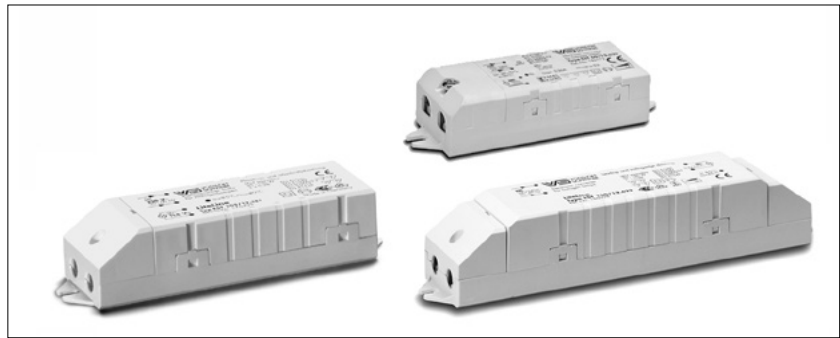

Type	Ref. No.	Capacity range (W)	Voltage (V) prim. (±10%)	sec.	Nominal current A	Ambient temperature t_a (°C)	Casing temperature t_c (°C)	Drawing	Weight g
Dimensions: 22x36x103.5 mm									
EST 60/12.635	186173	10–60	220–240	10.2–12	0.258–0.260	–20 to 45	max. 85	A	70
Dimensions: 28x37x128 mm									
EST 70/12.380	186072	20–70	230–240	11.3–11.7	0.30–0.31	–20 to 45	max. 70	B	85
EST 105/12.381	186077	20–105	230–240	11.2–11.7	0.435–0.445	–20 to 40	max. 85	B	95
Dimensions: 33x37x185 mm									
EST 150/12.622	186098	50–150	230–240	11.2–11.6	0.595–0.605	–20 to 45	max. 85	C	175

1

2

3

4

5

6

7

8

9

10

LOW- AND MAINS VOLTAGE LAMP HOLDERS

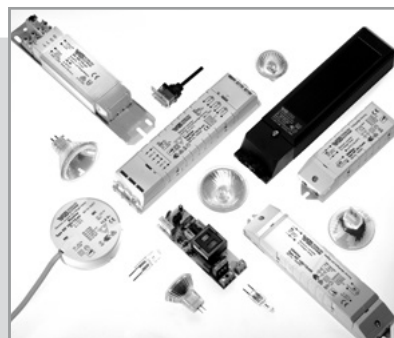

LAMP HOLDERS FOR HALOGEN INCANDESCENT LAMPS

As the tungsten-halogen cycle and the high lamp current can cause very high temperatures when operating low-voltage halogen lamps, close attention must be paid to the luminaire's thermal conditions and components must be made of high-grade materials.

VS lampholders for low-voltage halogen lamps

The following chapter contains Vossloh-Schwabe's comprehensive range of connection elements, lampholders and accessories for safe and reliable installation in accordance with the latest regulations and developments.

VS lampholders for mains voltage halogen lamps

The following chapter contains Vossloh-Schwabe's comprehensive range of lampholders for single-ended halogen lamps (GU/GZ10 and G9 bases), lampholders for bayonet lamps (B22d bases) as well as lampholders for double-ended tubular lamps (R7s base).



5

Lampholders for Halogen Incandescent Lamps

Lampholders for low-voltage halogen incandescent lamps

G4, GZ4, G5.3, GX5.3, G6.35, GY6.35 lampholders, accessories

Lampholders with separate mounting spring for GU4 lamps

GX5.3 lamp connectors

GU5.3 lampholders

Lampholders with separate mounting spring for GU5.3 lamps

G53 lamp connectors

162-167

162-163

164

165

165

166

167

Lampholders for mains voltage halogen incandescent lamps

G9 lampholders, accessories

GU10, GZ10 lampholders, accessories

R7s ceramic lampholders

R7s metal lampholders

Connectors

167-173

167-168

169-170

170-172

172

173

Technical details for incandescent lamps

General technical details

Glossary

206-215

228-236

237-239

1

2

3

4

5

6

7

8

9

10

G4, GZ4, G5.3, GX5.3, G6.35, GY6.35 Lampholders, Accessories

For low-voltage halogen incandescent lamps

The lampholders listed in this chapter permit the use of lamps with different bases. It is important to ensure that under no circumstances a lamp

with a smaller pin diameter is used if a lamp with a larger pin diameter has already been used.

G/GZ4, G/GX5.3, G/GY6.35 lampholder

Casing: LCP, black, T270

Nominal rating: 8/24 (for G4/GZ4 lamps: 4/24)

Multipoint contacts: CuNiZn

Push-in terminals for stranded conductors with ferrule on bare end of core \varnothing 1.4–1.8 mm

Fixing holes for screws M3

Weight: 2.4 g, unit: 1000 pcs.

Type: 33300

Ref. No.: 109547

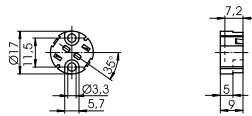

Cover caps

For push-fit onto lampholders type 333

External thread 20.8x2

Material: LCP

Moulded thread: M10x1

Weight: 3.8 g, unit: 1000 pcs.

Type: 97255

Ref. No.: 109548

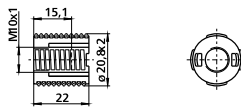

Screw rings

For components with external thread 20.8x2

Material: LCP

Weight: 1.4 g, unit: 1000 pcs.

Type: 97257

Ref. No.: 507490

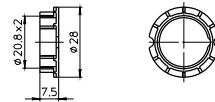

G/GZ4, G/GX5.3, G/GY6.35 lampholder

Casing: LCP, black, T270

Nominal rating: 8/24 (for G4/GZ4 lamps: 4/24)

Multipoint contacts: CuNiZn

Push-in terminals for stranded conductors with ferrule on bare end of core \varnothing 1.4–1.8 mm

Fixing holes for screws M3

Weight: 2.6 g, unit: 1000 pcs.

Type: 33400

Ref. No.: 109674

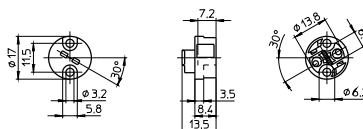

Lampholders for Halogen Incandescent Lamps

G/GZ4, G/GX5.3, G/GY6.35 lampholder

Casing: ceramic, cover plate: mica

T350

Nominal rating: 10/24

Contacts: Ni

Leads: Cu nickel-plated, stranded conductors

0.75 mm², PTFE-insulation, length: 140 mm

Fixing holes for screws M3

Weight: 6.8 g, unit: 500 pcs.

Type: 32400

Ref. No.: 100939

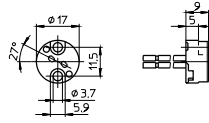

1

2

G/GZ4, G/GX5.3, G/GY6.35 lampholder

Casing: ceramic, cover plate: mica

T300

Nominal rating: 10/24

Multipoint contacts: CuNiZn

Leads: Cu nickel-plated, stranded conductors

0.75 mm², PTFE-insulation, length: 140 mm

Fixing holes for screws M3

Weight: 7.1 g, unit: 1000 pcs.

Type: 32700

Ref. No.: 101258

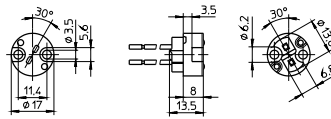

3

4

G/GZ4, G/GX5.3, G/GY6.35 lampholder

Casing: ceramic, cover plate: mica

T300, nominal rating: 10/24

Multipoint contacts: CuNiZn

Leads: Cu nickel-plated, stranded conductors

0.75 mm², PTFE-insulation, length: 140 mm

Fixing plate: zinc-coated polished steel

Fixing holes for screws M3

Weight: 8.8 g, unit: 1000 pcs.

Type: 32720

Ref. No.: 101274

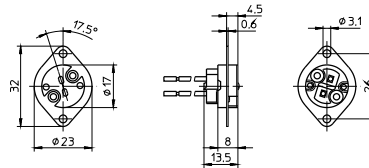

5

6

7

8

9

10

Lampholders with Separate Mounting Spring for GU4 Lamps

For low-voltage halogen incandescent lamps

G/GZ4, G/GX5.3, G/GY6.35 lampholder

Casing: LCP, black, T270

Nominal rating: 8/24 (for G4/GZ4 lamps: 4/24)

Multipoint contacts: CuNiZn

Push-in terminals for stranded conductors

with ferrule on bare end of core \varnothing 1.4–1.8 mm

Fixing holes for screws M3

For cover cap (see p. 162)

Weight: 2.4 g, unit: 1000 pcs.

Type: 33300

Ref. No.: 109547

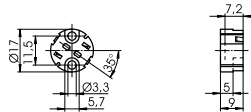

GU4 mounting spring for lamp

Material: stainless steel

For push-fit onto lampholders type 333 and 32210

Weight: 0.8 g, unit: 1000 pcs.

Type: 94095

Ref. No.: 109553

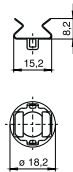

G/GZ4, G/GX5.3, G/GY6.35 lampholder

Casing: ceramic, cover plate: mica

T350

Nominal rating: 10/24

Contacts: Ni

Leads: Cu nickel-plated, stranded conductors

0.75 mm², PTFE-insulation, length: 140 mm

Fixing holes for screws M3

Weight: 6.8 g, unit: 500 pcs.

Type: 32400

Ref. No.: 100939

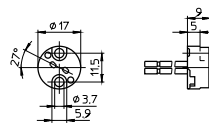

GX5.3 Lamp Connectors

For low-voltage halogen incandescent lamps

GX5.3 lamp connectors

Casing: ceramic, cover plate: mica
T300, nominal rating: 10/24

Multipoint contacts: Ni

Leads: Cu nickel-plated, stranded conductors
0.75 mm², PTFE-insulation, length: 140 mm

Weight: 7.8/8.5 g, unit: 500 pcs.

Type: 32600 holes for screws M3

Ref. No.: 101162

Type: 32620 threaded bushes M3

Ref. No.: 101207

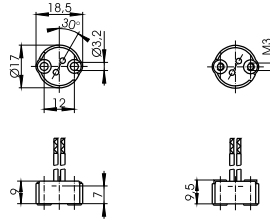

GU5.3 Lampholders

For low-voltage halogen incandescent lamps

GU5.3 lampholder

Casing: ceramic, cover plate: mica
T350, nominal rating: 10/24

Contacts: Ni

Leads: Cu nickel-plated, stranded conductors
0.75 mm², PTFE-insulation, length: 140 mm

Fixing holes for screws ST2.9

Mounting spring for lamp: stainless steel

Weight: 9.1 g, unit: 1000 pcs.

Type: 32480

Ref. No.: 106457

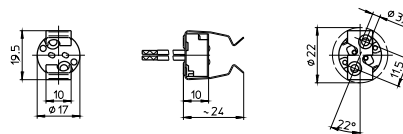

GU5.3 lampholders

Casing: ceramic, cover plate: mica

T300, nominal rating: 10/24, multipoint contacts: Ni

Leads: Cu nickel-plated, stranded conductors
0.75 mm², PTFE-insulation, length: 140 mm

Mounting spring for lamp: stainless steel

Weight: 11/12 g, unit: 500 pcs.

Type: 32680 holes for screws M3

Ref. No.: 101248

Type: 32690 threaded bushes M3

Ref. No.: 101253

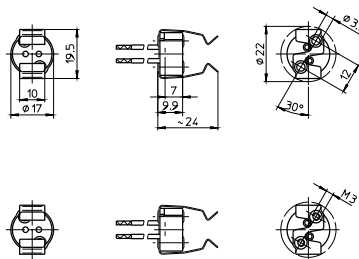

Lampholders with Separate Mounting Spring for GU5.3 Lamps

For low-voltage halogen incandescent lamps

G/GZ4, G/GX5.3, G/GY6.35 lampholder
 Casing: LCP, black, T270
 Nominal rating: 8/24 (for G4/GZ4 lamps: 4/24)
 Multipoint contacts: CuNiZn
 Push-in terminals for stranded conductors with ferrule on bare end of core \varnothing 1.4–1.8 mm
 Fixing holes for screws M3
 For cover cap (see p. 162)
 Weight: 2.4 g, unit: 1000 pcs.
 Type: 33300

Ref. No.: 506199

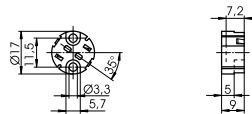

GU5.3 mounting spring for lamp
 Material: stainless steel
 For push-fit onto lampholders type 333
 Weight: 1.1 g, unit: 1000 pcs.
 Type: 94096

Ref. No.: 109554

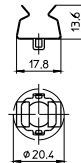

G/GZ4, G/GX5.3, G/GY6.35 lampholder
 Casing: ceramic, cover plate: mica
 T350
 Nominal rating: 10/24
 Contacts: Ni
 Leads: Cu nickel-plated, stranded conductors
 0.75 mm², PTFE-insulation, length: 140 mm
 Fixing holes for screws M3
 Weight: 6.8 g, unit: 500 pcs.
 Type: 32400

Ref. No.: 100939

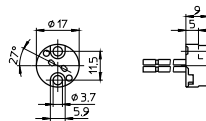

GU5.3 mounting spring for lamp
 Material: stainless steel
 The mounting spring has to be fastened to the lampholder 100939.
 The luminaire manufacturer is responsible for the attachment.
 Weight: 2 g, unit: 1000 pcs.
 Type: 94060

Ref. No.: 106256

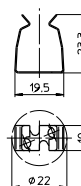

G53 Lamp Connectors

For low-voltage halogen incandescent lamps

G53 lamp connector

Casing: PPS, black

Nominal rating: 10/24

Contacts: CuNiZn

Lead: Cu tinned, stranded conductors 0.75 mm²,
Si-insulation, length: 140 mm

Fixing hole for screw M4

Lead exit: lateral

Weight: 4.4 g, unit: 1000 pcs.

Type: 33100

Ref. No.: 107694

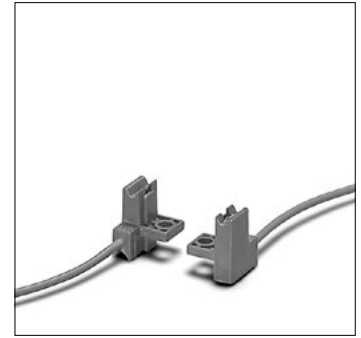
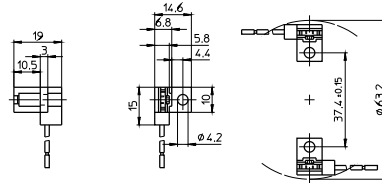

G9 Lampholders, Accessories

For mains voltage halogen incandescent lamps

For luminaires of protection class II

G9 lampholder

Casing: ceramic, cover plate: LCP, natural

T300, nominal rating: 2/250

Push-in twin terminals for stranded conductors
with ferrule on bare end of core ϕ 1.4–1.8 mm

Weight: 7.5 g, unit: 1000 pcs.

Type: 33800

Ref. No.: 568006

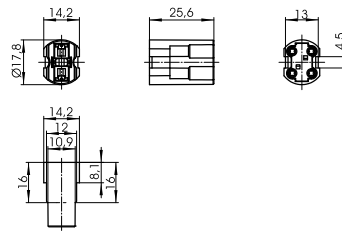

G9 lampholder

Casing: ceramic, T300, nominal rating: 2/250

Leads: Cu nickel-plated, stranded conductors
0.75 mm², double PTFE-insulation,
length: 180 mm

Weight: 12.8 g, unit: 1000 pcs.

Type: 33906

Ref. No.: 532610

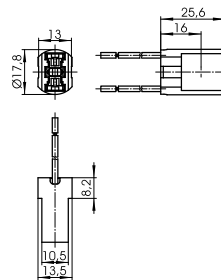

Metal bracket with nipple

For G9 lampholders type 338/339

Material: zinc-coated steel

Female nipple: M10x1

Weight: 7.8 g, unit: 1000 pcs.

Type: 94455

Ref. No.: 520880

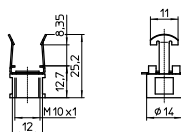

Lampholders for Halogen Incandescent Lamps

Cover cap for G9 lampholders type 339

Material: LCP

External thread 20.8x2

Moulded thread: M10x1

Weight: 3.2 g, unit: 1000 pcs.

Type: 97760

Ref. No.: 525583

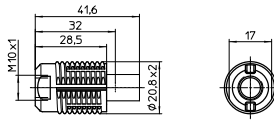

Screw rings

For components with external thread 20.8x2

Material: LCP

Weight: 1.4 g, unit: 1000 pcs.

Type: 97257

Ref. No.: 507490

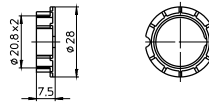

G9 lampholder

Casing: ceramic, cover plate: LCP, natural

T270, nominal rating: 2/250

Push-in twin terminals for stranded conductors with ferrule on bare end of core Ø 1.4–1.8 mm

Fixing holes for screws M3

Weight: 14.4 g, unit: 1000 pcs.

Type: 33500

Ref. No.: 502004

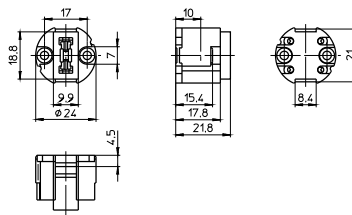

Cover caps for G9 lampholder 502004

Material: LCP

External thread 28x2 IEC 60399

Fixing holes for screws M3

Weight: 8.7/4.6 g, unit: 1000 pcs.

Type: 83310 female nipple: M10x1

Ref. No.: 505951

Type: 97268 moulded thread: M10x1

Ref. No.: 501942

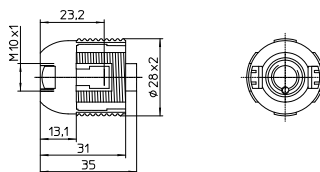

Screw ring

For components with external thread 28x2

Material: LCP

Ø 34 mm, height: 7.5 mm

Weight: 1.9 g, unit: 1000 pcs.

Type: 05202

Ref. No.: 508458

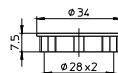

GU10, GZ10 Lampholders, Accessories

For mains voltage halogen incandescent lamps

GU10, GZ10 lampholders

Casing: LCP, black, T270, nominal rating: 2/250

Push-in twin terminals for stranded conductors with ferrule on bare end of core \varnothing 1.4–1.8 mm

Fixing holes for screws M3

Weight: 7 g, unit: 1000 pcs.

Type: 31000/31010

Ref. No.: 108979 GU10, GZ10 lampholder

Ref. No.: 109007 GU10 lampholder

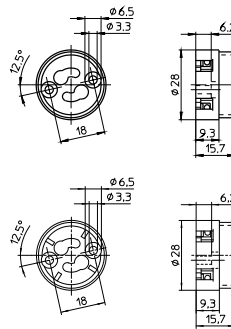

GU10, GZ10 lampholders

For luminaires of protection class II

Casing: LCP, black, T270, nominal rating: 2/250

Push-in twin terminals for stranded conductors with ferrule on bare end of core \varnothing 1.4–1.8 mm

Fixing holes for screws M3

Weight: 8 g, unit: 1000 pcs.

Type: 31020/31030

Ref. No.: 502111 GU10, GZ10 lampholder

Ref. No.: 502112 GU10 lampholder

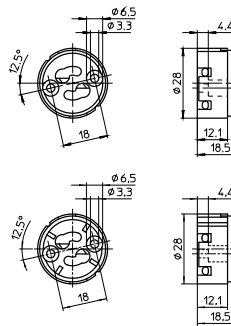

Cover cap for GU10, GZ10 lampholders type 310

Material: PA GF, black

Moulded thread: M10x1

Fixing holes for screws M3

Weight: 3.4 g, unit: 1000 pcs.

Type: 97244

Ref. No.: 109411

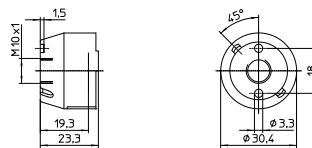

Cover cap for lampholders 502111/502112

External thread 32x2

Material: LCP

Moulded thread: M10x1

Weight: 6 g, unit: 1000 pcs.

Type: 97320

Ref. No.: 502064

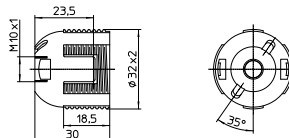

Lampholders for Halogen Incandescent Lamps

Screw ring

For components with external thread 32x2

Ø 38.9 mm, height: 7.5 mm

Material: PPS, black

Weight: 2.3 g, unit: 1000 pcs.

Type: 97282

Ref. No.: 502416

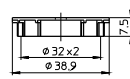

R7s Ceramic Lampholders

For mains voltage halogen incandescent lamps

The luminaire design must ensure protection from electric shock as well as sufficient creepage distances and clearances from live parts on the back of lampholder.

If the central hole on the bracket is used for fixing there must be a support within the luminaire to ensure that the bracket cannot be deformed.

Partly enclosed R7s lampholder

Casing: ceramic, T350

Contact pin: Cu, silver bulb

Nominal rating: 8/250

Leads: Cu nickel-plated, stranded conductors

0.75 mm², PTFE-insulation, length: 200 mm

With fixing screw M4

Weight: 25.4 g, unit: 400 pcs.

Type: 32300

Ref. No.: 100912

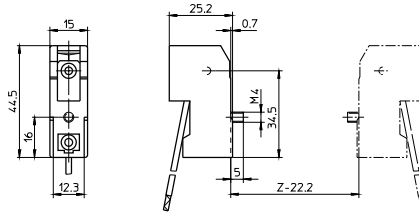

Partly enclosed R7s lampholder

Casing: ceramic, T350

Contact pin: Cu, silver bulb

Nominal rating: 8/250

Leads: Cu nickel-plated, stranded conductors

0.75 mm², PTFE-insulation, length: 200 mm

Oblong holes for screws M3/M4

Central hole for screw M4

Weight: 59.3 g, unit: 200 pcs.

Type: 32390 contact distance: 74.9 mm

Ref. No.: 107213

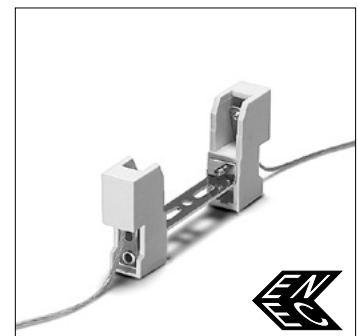
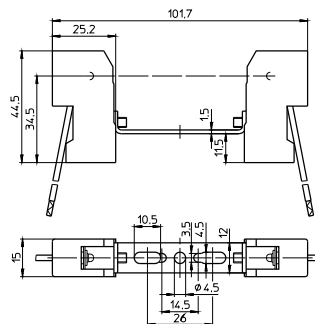

Partly enclosed R7s lampholder

Casing: ceramic, T350

Contact pin: Cu, silver bulb

Nominal rating: 8/250

Leads: Cu nickel-plated, stranded conductors

0.75 mm², PTFE-insulation, length: 200 mm

Oblong holes for screws M3/M4

Central hole for screw M4

Weight: 61 g, unit: 200 pcs.

Type: 32391 contact distance: 74.9 mm

Ref. No.: 107214

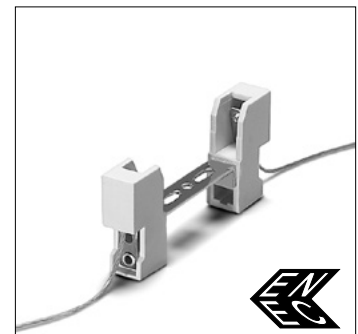
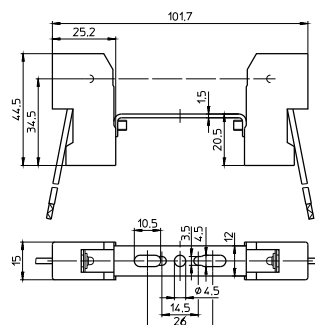

Lampholders for Halogen Incandescent Lamps

Partly enclosed R7s lampholder

Casing: ceramic, T350

Contact pin: Cu, silver bulb

Nominal rating: 8/250

Leads: Cu nickel-plated, stranded conductors

0.75 mm², PTFE-insulation, length: 200 mm

Oblong holes for screws M3/M4

Central hole for screw M4

Weight: 61.3 g, unit: 200 pcs.

Type: 32395 contact distance: 74.9 mm

Ref. No.: 107215

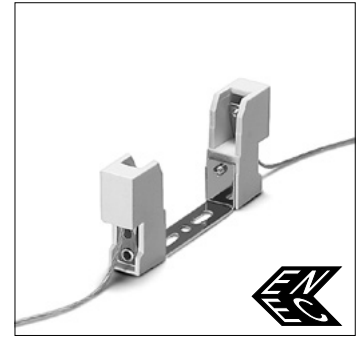
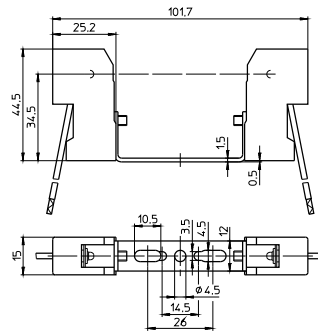

1

2

Partly enclosed R7s lampholder

Casing: ceramic, T350

Contact pin: Cu, silver bulb

Nominal rating: 8/250

Leads: Cu nickel-plated, stranded conductors

0.75 mm², PTFE-insulation, length: 200 mm

Oblong holes for screws M4

Central hole for screw M4

Weight: 64.9 g, unit: 200 pcs.

Type: 32310 contact distance: 114.2 mm

Ref. No.: 107195

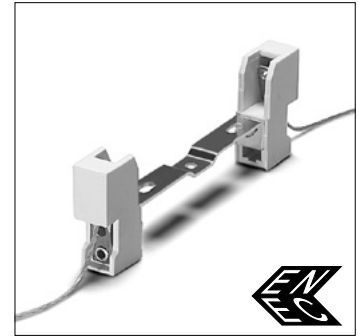
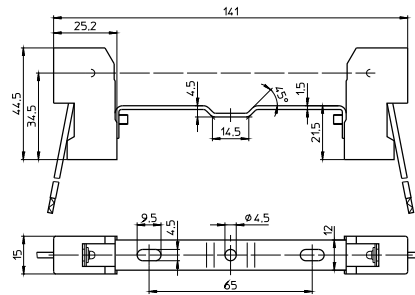

3

4

Partly enclosed R7s lampholder

Casing: ceramic, T350

Contact pin: Cu, silver bulb

Nominal rating: 8/250

Leads: Cu nickel-plated, stranded conductors

0.75 mm², PTFE-insulation, length: 200 mm

Oblong holes for screws M4

Central threaded bush M4

Weight: 66.5 g, unit: 200 pcs.

Type: 32320 contact distance: 114.2 mm

Ref. No.: 107194

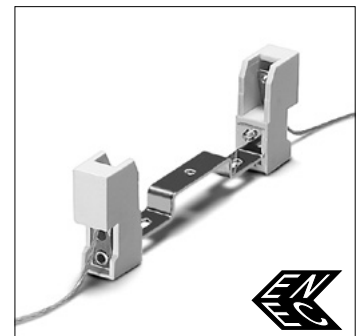
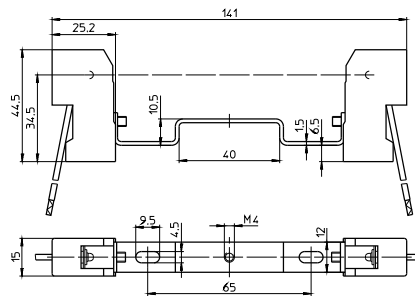

5

6

Partly enclosed R7s lampholder

Casing: ceramic, T350

Contact pin: Cu, silver bulb

Nominal rating: 8/250

Leads: Cu nickel-plated, stranded conductors

0.75 mm², PTFE-insulation, length: 200 mm

Oblong holes for screws M4

Central hole for screw M4

Weight: 65.4 g, unit: 200 pcs.

Type: 32340 contact distance: 114.2 mm

Ref. No.: 107193

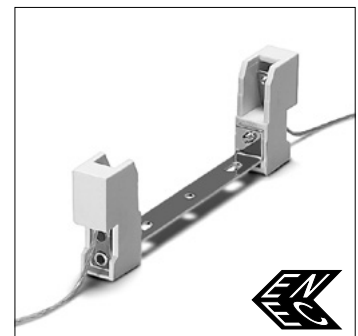
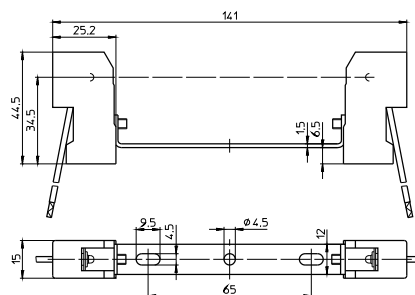

7

8

Partly enclosed R7s lampholder

Casing: ceramic, T350

Contact pin: Cu, silver bulb

Nominal rating: 8/250

Leads: Cu nickel-plated, stranded conductors

0.75 mm², PTFE-insulation, length: 200 mm

Oblong holes for screws M4

Central hole for screw M5

Weight: 66.7 g, unit: 200 pcs.

Type: 32360 contact distance: 114.2 mm

Ref. No.: 107192

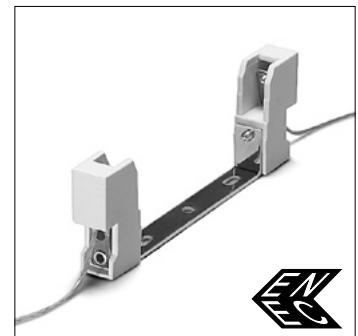
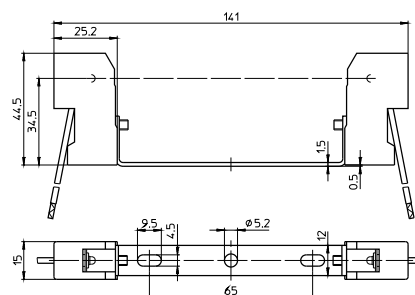

9

10

Lampholders for Halogen Incandescent Lamps

Partly enclosed R7s lampholder

Casing: ceramic, T350

Contact pin: Cu, silver bulb

Nominal rating: 8/250

Leads: Cu nickel-plated, stranded conductors

0.75 mm², PTFE-insulation, length: 200 mm

Oblong holes for screws M4

Central hole for screw M5

Weight: 71.3 g, unit: 200 pcs.

Type: 32380 contact distance: 114.2 mm

Ref. No.: 109497

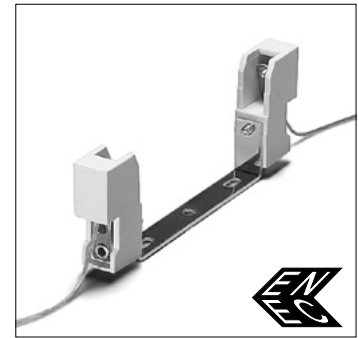
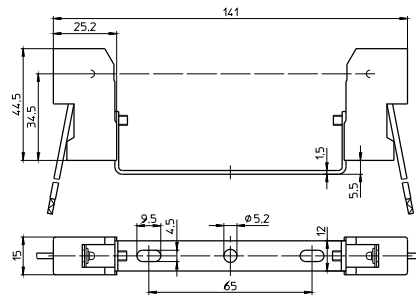

R7s Metal Lampholders

For mains voltage halogen incandescent lamps

R7s lampholder

Casing: Al, T300, contact pin: Cu, silver bulb

Nominal rating: 10/250

Lead: Cu nickel-plated, stranded conductors

1 mm², PTFE-insulation, length: 300 mm

Fixing flange

Fixing holes for screws M3

Weight: 15.7 g, unit: 1000 pcs.

Type: 30523

Ref. No.: 100710

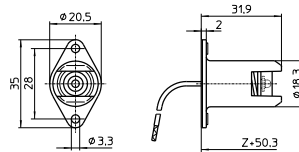

R7s lampholder

Casing: Al, T300, contact pin: Cu, silver bulb

Nominal rating: 10/250

Lead: Cu nickel-plated, stranded conductors

1 mm², PTFE-insulation, length: 350 mm

Fixing bracket

Fixing holes for screws M4

Weight: 24.8 g, unit: 500 pcs.

Type: 30550

Ref. No.: 100720

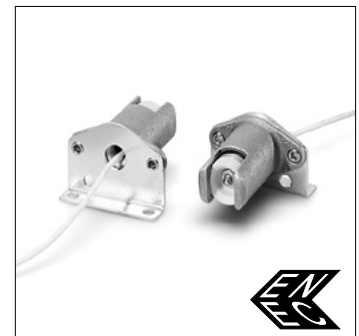
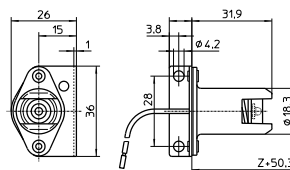

Connectors

Modular system for various assembly options
 VDE registered
 Connectors can be delivered pre-assembled
 with lampholder and lead assemblies

Male and female plug
 Nominal rating: 7/600
 For cable: 0.3–0.9 mm²
 For crimping on the end of lead
 Material: brass, tinned
 Weight: 0.1 g, unit: 5000 pcs.

Type: 93088 male plug

Ref. No.: 505251

Type: 93089 female plug

Ref. No.: 506807

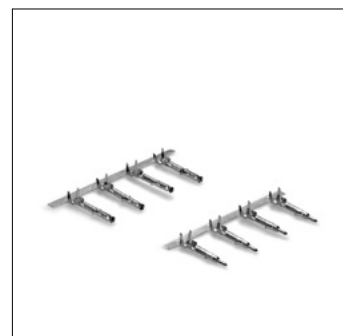
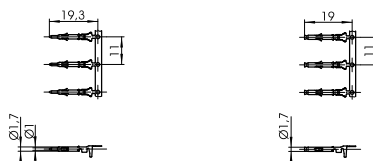

Male and female casing
 For male and female plug
 For push-fit assembly
 Material: PA, natural
 Weight: 0.8/1 g, unit: 2500 pcs.

Type: 97355 male casing

Ref. No.: 509295 UL94V-0

Ref. No.: 508562 UL94V-2

Type: 97356 female casing

Ref. No.: 509296 UL94V-0

Ref. No.: 508563 UL94V-2



1

2

3

4

5

6

7

8

9

10

LAMPHOLDERS MADE OF THERMO- PLASTICS, METAL AND PORCELAIN



LAMPHOLDERS FOR GENERAL-SERVICE INCANDESCENT LAMPS AND LED RETROFIT LAMPS

The general-service light bulb owes its name to its bulbous shape, which has remained almost unchanged to this day. The tungsten filament contained within the bulb's glass shell, in which there used to be a vacuum but which is nowadays more usually filled with an inert gas, begins to glow as electricity is passed through it. Despite the considerable technical progress that has been made, the typical disadvantages associated with light bulbs still remain. For instance, incandescent lamps mainly radiate heat with no more than 5–10% light output and have a service life of approx. 1000 operating hours. As a result of energy-efficiency regulations in the various regions of the world, the use of all-purpose incandescent lamps has been limited or even banned.

LED Retrofit lamps that comply with energy-efficiency regulations are being used as a replacement for all-purpose incandescent lamps and use the same lampholder systems found with E12/E14, E26/E27, E39/E40, B15d and B22d bases.

This makes it easy to switch to the more economical LED retrofit lamp when replacing a defective incandescent lamp. It is not necessary to replace the lampholder.

VS lampholders

Depending on the operating conditions, lampholders can be made of thermoplastics, metal or porcelain. Metal lampholders are most often used for high-grade decorative luminaires. In accordance with protection class I, metal lampholders must be included in the measures taken to earth the luminaire.

Due to their heat resistance, Edison lampholders made of porcelain are frequently used for higher-output lamps. Classic lampholder materials like metal and porcelain are increasingly being displaced by modern thermoplastics.



E14 lampholders

E14 thermoplastic lampholders, one-piece and cover caps
 E14 thermoplastic lampholders, three-piece
 E14 metal lampholders, three-piece

176–183

176–179
 180–182
 182–183

E27 lampholders

E27 thermoplastic lampholders, one-piece and cover caps
 E27 renovation kit lampholders
 E27 thermoplastic lampholders, three-piece
 E27 porcelain lampholders
 E27 metal lampholders, three-piece
 E27 metal pull-switch lampholders
 E27 thermoplastic rocker switch lampholders
 E27 festoon lampholders

184–199

184–188
 189
 189–192
 193–194
 195
 196
 197
 198

B22d lampholders, accessories**199****Accessories for E14, E27 and B22d lampholders****200–203****E40 porcelain lampholders****204****Technical details for incandescent lamps****206–215**

General technical details
 Glossary

228–236
 237–239

1

2

3

4

5

6

7

8

9

10

E14 Thermoplastic Lampholders, One-piece

For incandescent lamps with base E14

E14 lampholders with temperature marking
Brass-finished versions are available on request.

E14 lampholders, for cover caps

Plain casing

Casing: PET GF, T210, nominal rating: 2/250

Push-in twin terminals: 0.5–1.5 mm²

Rear fixing holes for self-tapping screws

acc. to ISO 1481/7049-ST2.9-C/F

Weight: 11.3/11.4 g, unit: 1000 pcs.

Type: 64001

Ref. No.: 109384 white

Ref. No.: 109383 black

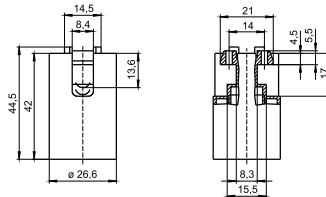

E14 lampholders, for cover caps

External thread 28x2 IEC 60399

Casing: PET GF, T210, nominal rating: 2/250

Push-in twin terminals: 0.5–1.5 mm²

Rear fixing holes for self-tapping screws

acc. to ISO 1481/7049-ST2.9-C/F

Weight: 12.5/12.2 g, unit: 1000 pcs.

Type: 64101

Ref. No.: 109387 white

Ref. No.: 109386 black

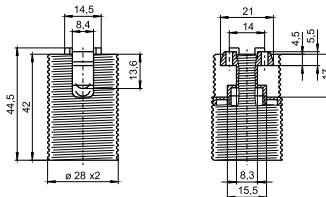

E14 lampholders, for cover caps

External thread 28x2 IEC 60399, with flange

Casing: PET GF, T210, nominal rating: 2/250

Push-in twin terminals: 0.5–1.5 mm²

Rear fixing holes for self-tapping screws

acc. to ISO 1481/7049-ST2.9-C/F

Weight: 12.7 g, unit: 1000 pcs.

Type: 64201

Ref. No.: 503924 white

Ref. No.: 503923 black

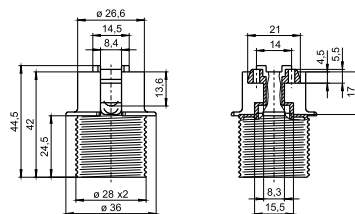

E14 lampholders, for cover caps

Profiled shape, short external thread 28x2 IEC 60399

Casing: PET GF, T210, Nominal rating: 2/250

Push-in twin terminals: 0.5–1.5 mm²

Rear fixing holes for self-tapping screws

acc. to ISO 1481/7049-ST2.9-C/F

Weight: 8.5/8.4 g, unit: 1000 pcs.

Type: 64370

Ref. No.: 546456 white

Ref. No.: 546454 black

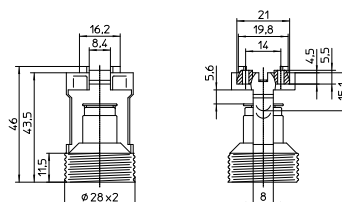

Lampholders for General-service Incandescent

E14 lampholders

Profiled shape, short external thread 28x2 IEC 60399

Casing: PET GF, T210, nominal rating: 2/250

Push-in twin terminals: 0.5–1.5 mm²

For clipping-in

Weight: 6.6/6.8 g, unit: 1000 pcs.

Type: 64360

Ref. No.: 506247 white

Ref. No.: 506249 black

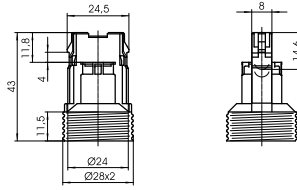

1

2

E14 lampholders

Profiled shape, nominal rating: 2/250

Push-in twin terminals: 0.5–1.5 mm²

Lateral push-fit foot for cut-out 10x20 mm

for wall thickness 0.6–1.3 mm

Tilt of lamp axis: 6°

For cover cap 503579

Weight: 9.1/9.2 g, unit: 1000 pcs.

Type: 64307

Ref. No.: 108983 PBT GF, white, T180/–20

Ref. No.: 509263 PET GF, natural, T210

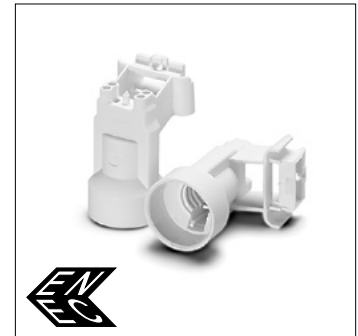
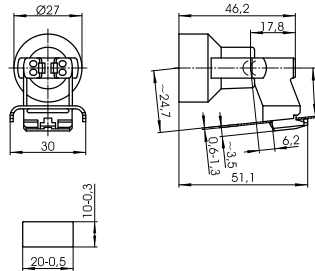

3

4

E14 lampholder

Profiled shape

Casing: PBT GF, white, T180/–20

Nominal rating: 2/250

Push-in twin terminals: 0.5–1.5 mm²

For insertion, clipping-in or bayonet fixing

for plastic cut-out: Ø 27.5 mm

with wall thickness: 2.5 mm

Weight: 7.1 g, unit: 1000 pcs.

Type: 64308

Ref. No.: 533818

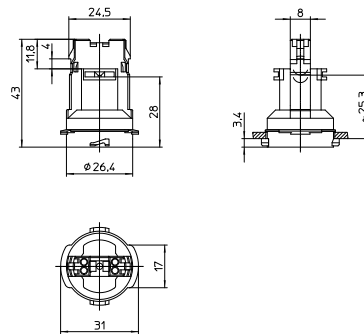

5

6

E14 lampholder

Profiled shape

Casing: PBT GF, white, T180/–20

Nominal rating: 2/250

Push-in twin terminals: 0.5–1.5mm²

For insertion: clipping-in for

a profiled hole with wall thickness 0.6–0.7 mm

Weight: 9 g, packaging unit: 1000 pcs.

Type: 64314

Ref. No.: on request

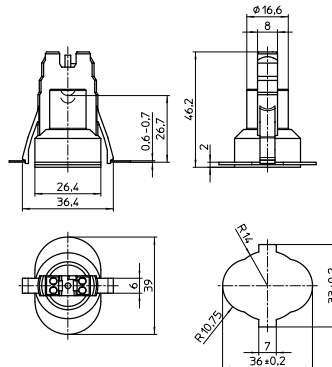

7

8

E14 double lampholder

Profiled shape

Casing: PBT GF, white

Nominal rating: 2/250

Push-in twin terminals: 0.5–1.5mm²

For insertion: clipping-in for a profiled hole

Weight: 29 g, packaging unit: 100 pcs.

Type: 64380

Ref. No.: 565816

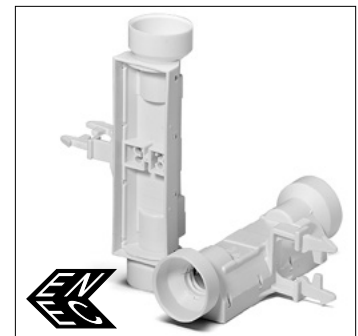
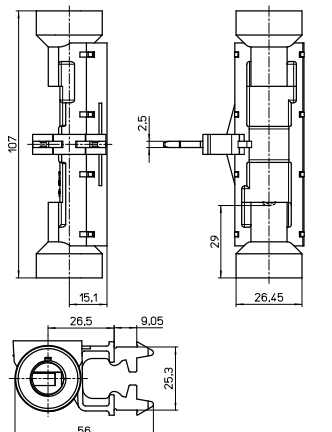

9

10

Cover Caps

For E14 thermoplastic lampholders, one-piece

Brass-finished versions are available on request.

Cover cap for lampholders type 64307

For luminaires of protection class II

Material: PP, white

Weight: 2.4 g, unit: 1000 pcs.

Type: 97322

Ref. No.: 503579

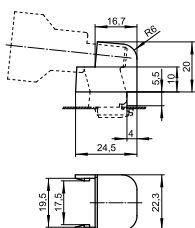

Cover caps

Material: PA GF

Female nipple: M10x1

Weight: 7.6/8.8 g, unit: 1000 pcs.

Type: 85075

Ref. No.: 109110 white

Ref. No.: 109112 black

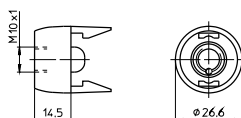

Cover caps

Material: PA GF

Moulded thread: M10x1

Rotation stop: external

Weight: 2.7 g, unit: 1000 pcs.

Type: 97636

Ref. No.: 109676 white

Ref. No.: 109677 black

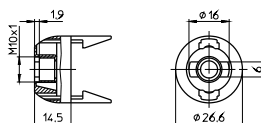

Cover caps

Material: PA GF

Moulded thread: M10x1

Rotation stop: external

With locking screw

Weight: 3 g, unit: 1000 pcs.

Type: 85076

Ref. No.: 400818 white

Ref. No.: 400817 black

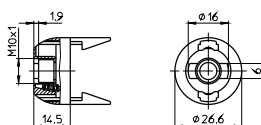

Lampholders for General-service Incandescent

Cover caps

Height: 19 mm

Material: PA GF

Moulded thread: M10x1

Rotation stop: external

With locking screw

Weight: 3.6/3.5 g, unit: 1000 pcs.

Type: 85074

Ref. No.: 520735 white

Ref. No.: 520736 black

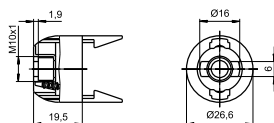

1

2

Cover caps

Height: 19 mm

Material: PA GF

Profiled hole: Ø 10.4 mm

Rotation stop: internal and external

Weight: 2.7 g, unit: 1000 pcs.

Type: 97708

Ref. No.: 520759 white

Ref. No.: 520760 black

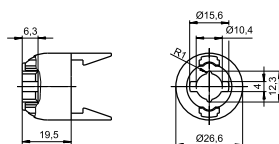

3

4

Cover caps

With peg

With integrated cord grip

For leads H03VVH2-F 2X0.75

Material: PA GF

Weight: 4.2/4.3 g, unit: 1000 pcs.

Type: 97000

Ref. No.: 503457 white

Ref. No.: 503458 black

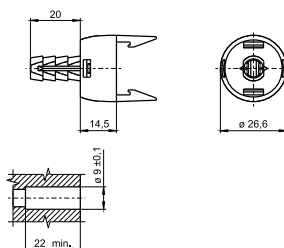

5

6

Cover cap

With male nipple: M10x1

With rotation stop

With integrated cord grip

For leads H03VVH2-F 2X0.75

Material: PA GF, white

Weight: 4.1 g, unit: 1000 pcs.

Type: 97037

Ref. No.: 508067

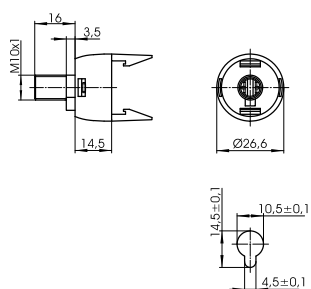

7

8

9

10

E14 Thermoplastic Lampholders, Three-piece

For incandescent lamps with base E14

Nominal rating: 2/250
 Temperature marking: T190
 Brass-finished versions are available on request.

Inserts

Material: PET GF, black

Casing lock

Weight: 3.9/3.2 g, unit: 1000 pcs.

Type: 81095 screw terminals: 0.5–2.5 mm²

Ref. No.: 103424

Type: 81096 push-in twin terminals: 0.5–1.5 mm²

Ref. No.: 107716



Plain casings

Material: PET GF

Weight: 9/8.5 g, unit: 1000 pcs.

Type: 81093

Ref. No.: 103415 white

Ref. No.: 103414 black

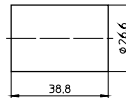

Threaded casings 28x2 IEC 60399

Material: PET GF

Weight: 9.8/9.6 g, unit: 1000 pcs.

Type: 81109

Ref. No.: 103431 white

Ref. No.: 103430 black

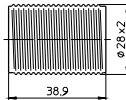

Threaded casings 28x2 IEC 60399

With flange

Material: PET GF

Weight: 10.6/10.4 g, unit: 1000 pcs.

Type: 81120

Ref. No.: 103443 white

Ref. No.: 103442 black

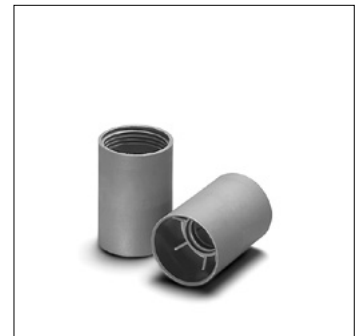
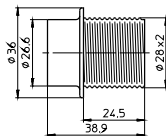

Lampholders for General-service Incandescent

Caps

Material: PA GF

Female nipple: M10x1

Height: 13.7 mm

Weight: 6.9/7.2 g, unit: 1000 pcs.

Type: 81002

Ref. No.: 109102 white

Ref. No.: 109103 black

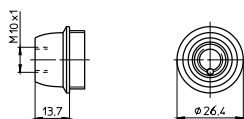

1

Caps

Material: PA GF

Female nipple: M10x1

Height: 18.7 mm

Weight: 7/7.3 g, unit: 1000 pcs.

Type: 81024

Ref. No.: 109805 white

Ref. No.: 109145 black

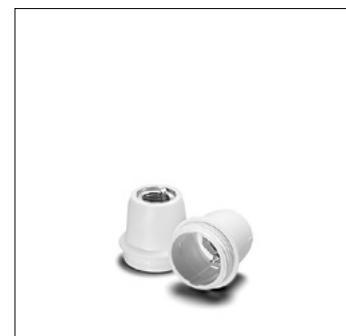
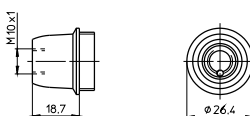

3

4

Caps

Material: PA GF

Moulded thread: M10x1

Rotation stop: external

Height: 13.7 mm

Weight: 3.3/3.7 g, unit: 1000 pcs.

Type: 96159

Ref. No.: 109095 white

Ref. No.: 109084 black

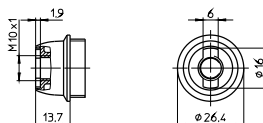

5

6

Caps

Material: PA GF

Moulded thread: M10x1

Rotation stop: external

Height: 18.7 mm

Weight: 3.6/3.9 g, unit: 1000 pcs.

Type: 96211

Ref. No.: 109149 white

Ref. No.: 109150 black

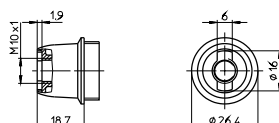

7

8

Caps

Material: PA GF

Moulded thread: M10x1

Rotation stop: external

With locking screw

Height: 13.7 mm

Weight: 3.7/4 g, unit: 1000 pcs.

Type: 81130

Ref. No.: 109041 white

Ref. No.: 109054 black

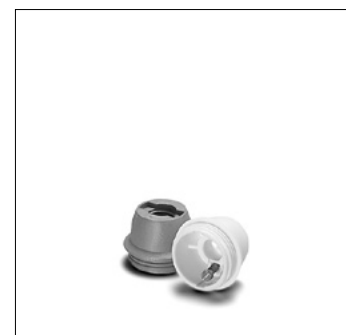
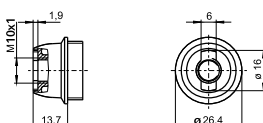

9

10

Lampholders for General-service Incandescent

Caps

Material: PA GF
 Moulded thread: M10x1
 Rotation stop: external
 With locking screw
 Height: 18.7 mm
 Weight: 3.9/4.3 g, unit: 1000 pcs.
 Type: 81132

Ref. No.: 109152 white

Ref. No.: 109153 black

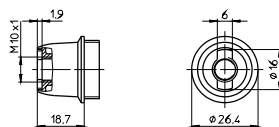

Caps

Material: PA GF
 Round hole: \varnothing 10.5 mm
 Rotation stop: internal
 Height: 13.7 mm
 Weight: 3.3 g, unit: 1000 pcs.
 Type: 96004

Ref. No.: 508352 white

Ref. No.: 508353 black

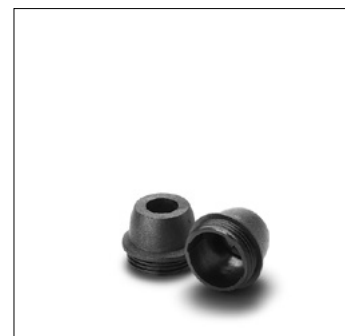
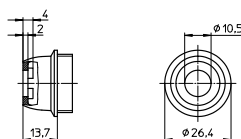

E14 Metal Lampholders, Three-piece

For incandescent lamps with base E14

Nominal rating: 2/250
 Temperature marking: T190/T240
 Type: 513 plain casing
 Type: 514 threaded casing 28x2

Insert

Material: porcelain, white
 Casing lock
 Screw terminals: 0.5–2.5 mm²
 Weight: 10.3 g, unit: 500 pcs.
 Type: 83142

Ref. No.: 550375



Plain casings

Material: zinc-coated polished steel
 Weight: 14.3/14.2/18.3/18.2 g
 Unit: 500 pcs.
 Type: 81019 insulating threaded ring: PET, T190

Ref. No.: 103359 chrome-finish

Ref. No.: 103360 brass-finish

Type: 81018 insulating threaded ring: steatite, T240

Ref. No.: 507049 chrome-finish

Ref. No.: 507050 brass-finish

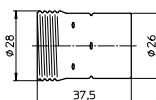

Lampholders for General-service Incandescent

Threaded casings 28x2 IEC 60399

Material: zinc-coated polished steel

Weight: 14.4/14.4/18.9/18.9 g

Unit: 500 pcs.

Type: 81022 insulating threaded ring: PET, T190

Ref. No.: 103365 chrome-finish

Ref. No.: 103366 brass-finish

Type: 81017 insulating threaded ring: steatite, T240

Ref. No.: 507052 chrome-finish

Ref. No.: 507053 brass-finish

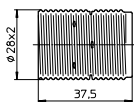

1

2

Caps

Material: zinc-coated polished steel

Female nipple: M10x1

Weight: 7.2/7.1/7.9/7.8 g

Unit: 500 pcs.

Type: 80006

Ref. No.: 102946 chrome-finish

Ref. No.: 102947 brass-finish

Type: 80003 with earth terminal

Ref. No.: 102938 chrome-finish

Ref. No.: 102939 brass-finish

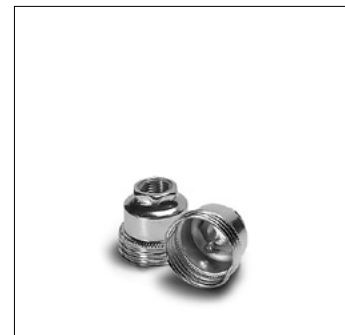
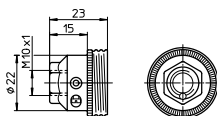
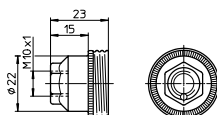

3

4

5

6

7

8

9

10

E27 Thermoplastic Lampholders, One-piece

For incandescent lamps with base E27

E27 lampholders

Brass-finished versions are available on request.

E27 lampholders, for cover caps

Plain casing

Casing: PET GF, T210

Nominal rating: 4/250

Push-in twin terminals: 0.5–2.5 mm²

Fixing holes for screws M4

Weight: 17.4 g, unit: 500 pcs.

Type: 64401

Ref. No.: 108936 white

Ref. No.: 500810 black

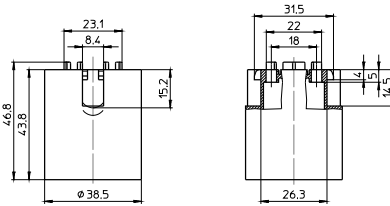

E27 lampholders, for cover caps

External thread 40x2.5 IEC 60399

Casing: PET GF, T210

Nominal rating: 4/250

Push-in twin terminals: 0.5–2.5 mm²

Fixing holes for screws M4

Weight: 19.1/18.8 g, unit: 500 pcs.

Type: 64501

Ref. No.: 108965 white

Ref. No.: 109429 black

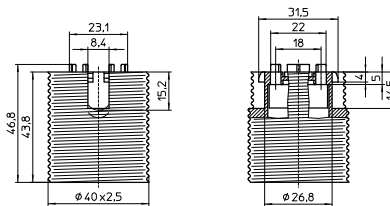

E27 lampholders, for cover caps

External thread 40x2.5 IEC 60399, with flange

Casing: PET GF, T210

Nominal rating: 4/250

Push-in twin terminals: 0.5–2.5 mm²

Fixing holes for screws M4

Weight: 21.4 g, unit: 500 pcs.

Type: 64601

Ref. No.: 501358 white

Ref. No.: 501356 black

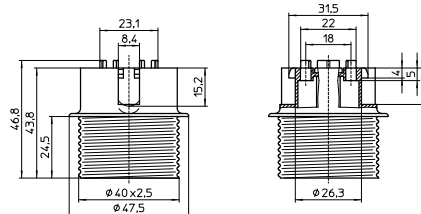

E27 lampholders, for cover caps

Profiled shape, external thread 40x2.5 IEC 60399

Casing: PET GF, T210, nominal rating: 4/250

Push-in twin terminals: 0.5–2.5 mm²

Fixing holes for screws M3

Rear fixing holes for self-tapping screws

acc. to ISO 1481/7049-ST3.9-C/F

Weight: 14.8/14.9 g, unit: 500 pcs.

Type: 64719

Ref. No.: 504303 white

Ref. No.: 504302 black

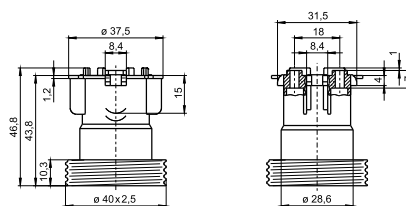

Lampholders for General-service Incandescent

E27 lampholders, for cover caps
 Profiled shape, external thread 40x2.5 IEC 60399
 Casing: PET GF, T210, nominal rating: 4/250
 Push-in twin terminals: 0.5–2.5 mm²
 Fixing holes for screws M3
 Rear fixing holes for self-tapping screws
 acc. to ISO 1481/7049-ST3.9-C/F
 Weight: 11.4/11.3 g, unit: 500 pcs.
 Type: 64775

Ref. No.: 506255 white
Ref. No.: 506257 black

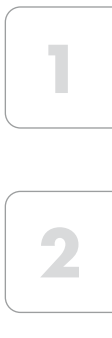
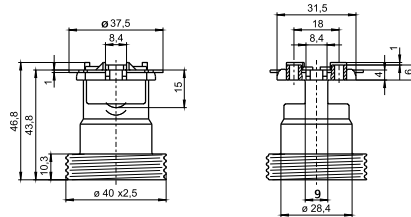

E27 lampholders
 Profiled shape, plain, nominal rating: 4/250
 Screw terminals: 0.5–2.5 mm²
 Fixing holes for screws M3
 Rear fixing holes for self-tapping screws
 acc. to ISO 1481/7049-ST3.9-C/F
 Weight: 11.7/11.5 g, unit: 500 pcs.
 Type: 64785

Ref. No.: 506263 PET GF, white, T210
Ref. No.: 506265 PET GF, black, T210

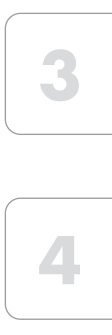
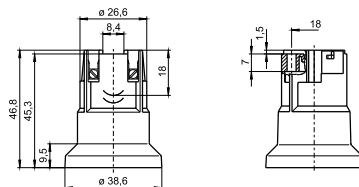

E27 lampholder
 For cover caps type 97545/80023 (see p. 187)
 Profiled shape, plain, nominal rating: 4/250
 Push-in twin terminals: 0.5–2.5 mm²
 Fixing holes for screws M3
 Rear fixing holes for self-tapping screws
 acc. to ISO 1481/7049-ST3.9-C/F
 Weight: 11.5 g, unit: 500 pcs.
 Type: 64770

Ref. No.: 108953 PET GF, natural, T210

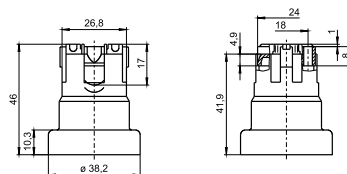

E27 lampholder
 For luminaires of protection class II
 Profiled shape, plain
 Casing: PET GF, white, T210
 Nominal rating: 4/250
 Screw terminals: 0.5–2.5 mm²
 Lateral fixing hole for screw M4
 Tilt of lamp axis: 3°
 Weight: 15.2 g, unit: 500 pcs.
 Type: 64781

Ref. No.: 503041

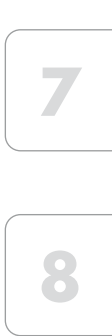
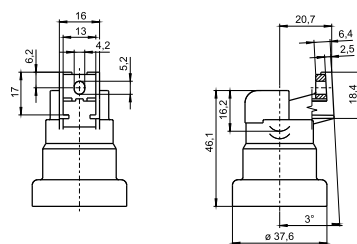

E27 lampholders
 Profiled shape, plain
 Casing: PET GF, T210
 Nominal rating: 4/250
 Push-in twin terminals: 0.5–2.5 mm²
 Lateral fixing hole for screw M4
 Tilt of lamp axis: 3°
 Weight: 13.3 g, unit: 500 pcs.
 Type: 64740

Ref. No.: 108747 white
Ref. No.: 529599 natural

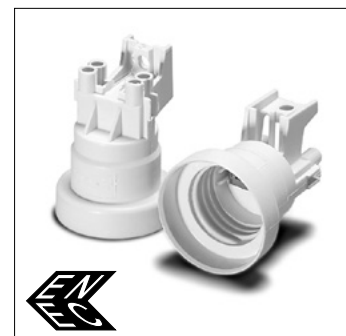
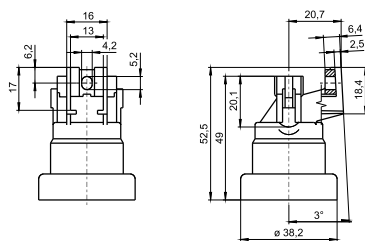

Lampholders for General-service Incandescent

E27 lampholder

Profiled shape, external thread 40x2.5 IEC 60399

Casing: PET GF, natural, T210, nominal rating: 4/250

Push-in twin terminals: 0.5–2.5 mm²

Lateral push-fit foot for cut-out 10x20 mm

Fixing clips for wall thickness 0.4–1 mm

Tilt of lamp axis: 12°

For cover cap 504615 (see below)

Weight: 14.7 g, unit: 500 pcs.

Type: 64741

Ref. No.: 108758

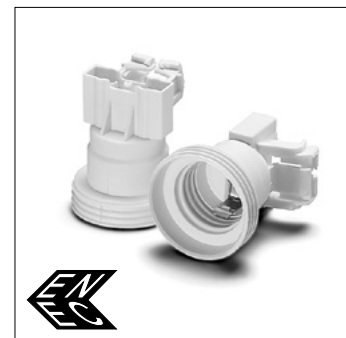
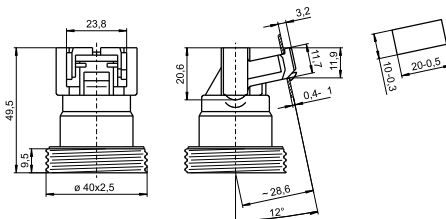

Cover Caps

For E27 thermoplastic lampholders, one-piece and for B22d thermoplastic lampholders

Cover cap for lampholder 108758 (see above)

For luminaires of protection class II

Material: PA GF, white

Weight: 2.7 g, unit: 500 pcs.

Type: 97321

Ref. No.: 504615

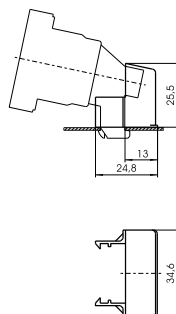

Protection caps for E27 lampholders with bracket with earth connection 400772 (s. p. 201)

For lampholder type 64770/64785 (s. p. 185)

For luminaires of protection class II

Material: PA GF, natural

Weight: 4.8 g, unit: 500 pcs.

Type: 97497

Ref. No.: 526886

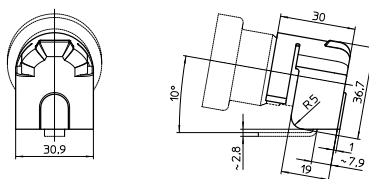

Cover caps

Material: PA GF

Female nipple: M10x1

Weight: 9.6/9.9 g, unit: 500 pcs.

Type: 85070

Ref. No.: 109077 white

Ref. No.: 109092 black

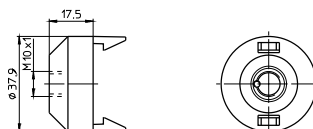

Lampholders for General-service Incandescent

Cover caps

Material: PA GF

Moulded thread: M10x1

Cross groove for rotation stop: external

Weight: 4.4/4.6 g, unit: 500 pcs.

Type: 97665

Ref. No.: 109679 white

Ref. No.: 109680 black

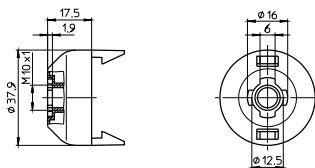

1

2

Cover caps

Material: PA GF

Moulded thread: M10x1

Cross groove for rotation stop: external

With lateral hole

Weight: 4.4/4.6 g, unit: 500 pcs.

Type: 97664

Ref. No.: 109795 white

Ref. No.: 109794 black

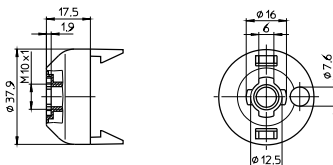

3

4

Cover caps

Material: PA GF

Moulded thread: M10x1

Cross groove for rotation stop: external

With locking screw

Weight: 4.7/4.9 g, unit: 500 pcs.

Type: 85077

Ref. No.: 400819 white

Ref. No.: 400820 black

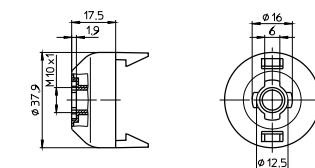

5

6

Cover caps

For E27 lampholders type 64770

Material: PA GF, black

Moulded thread: M10x1

Cross groove for rotation stop: external

Weight: 3.1/3.4 g, unit: 500 pcs.

Type: 97545

Ref. No.: 532390

Type: 80023 with locking screw

Ref. No.: 532391

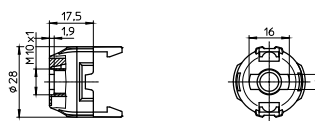

7

8

Cover caps

Material: PA GF

Profiled hole: Ø 10.4 mm

Rotation stop: internal and external

Weight: 5.7/5.9 g, unit: 500 pcs.

Type: 97698

Ref. No.: 109560 white

Ref. No.: 109184 black

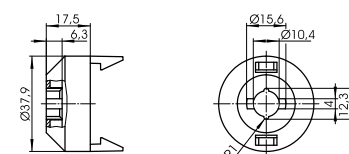

9

10

Lampholders for General-service Incandescent

Cover caps

Material: PA GF

Round hole: \varnothing 10.5 mm

Rotation stop: external

Fixing holes for screws M4

Weight: 5.4/5.5 g, unit: 500 pcs.

Type: 97511

Ref. No.: 109045 white

Ref. No.: 109062 black

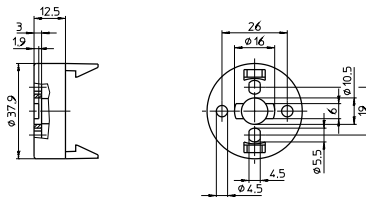

Cover caps

Conical shape

Material: PA GF

Moulded thread: M10x1

Cross groove for rotation stop: external

Weight: 8.9/8.8 g, unit: 500 pcs.

Type: 97260

Ref. No.: 109555 white

Ref. No.: 109556 black

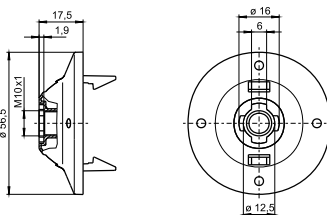

Cover caps

Conical shape

Material: PA GF

With integrated cord grip

For leads H03VV-F 2X0.5 or

H03VV-F 2X0.75

Weight: 10.6/10.5 g, unit: 500 pcs.

Type: 83282

Ref. No.: 109159 white

Ref. No.: 109462 black

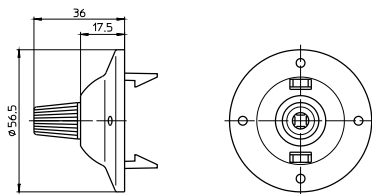

Cover caps

Material: PA GF

With integrated cord grip

For leads H03VV-F 2X0.5 or

H03VV-F 2X0.75

Weight: 6.6/5.8 g, unit: 500 pcs.

Type: 83283

Ref. No.: 504769 white

Ref. No.: 507075 black

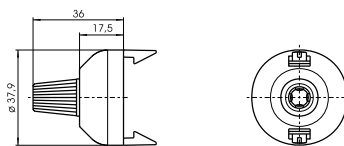

E27 Renovation Kit Lampholders

For incandescent lamps with base E27

E27 renovation kit lampholders with suspension
 Profiled shaped lampholder 64770 – T210
 Cover cap with cord grip 532394
 Nominal rating: 4/250
 Lead: Cu, stranded conductors 0.75 mm²,
 double PVC-insulation, length: 150 mm
 Weight: 25.8/26.2 g, unit: 150 pcs.
 Type: 64770

Ref. No.: 564680 black, with screw terminal
Ref. No.: 564681 black, with push-in terminal

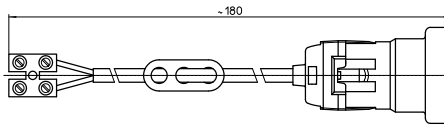

1

2

3

4

E27 Thermoplastic Lampholders, Three-piece

For incandescent lamps with base E27

Nominal rating: 4/250
 Temperature marking: T190
 Brass-finished versions are available on request.

Inserts

Material: PET GF, black

Casing lock

Weight: 5.7/6.1 g, unit: 500 pcs.

Type: 83285 push-in terminals: 0.5–1.5 mm²

Ref. No.: 103643

Type: 83011 screw terminals: 0.5–2.5 mm²

Ref. No.: 103520



Plain casings

Material: PET GF

Weight: 14.5/14.3 g, unit: 500 pcs.

Type: 83000

Ref. No.: 103468 white

Ref. No.: 103467 black

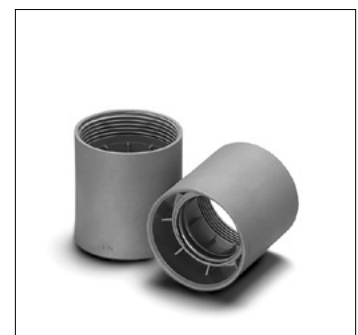
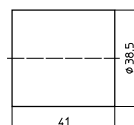

5

6

7

8

9

10

Lampholders for General-service Incandescent

Threaded casings 40x2.5 IEC 60399

Material: PET GF

Weight: 17/16.1 g, unit: 500 pcs.

Type: 83002

Ref. No.: 103484 white

Ref. No.: 103483 black

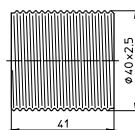

Threaded casings 40x2.5 IEC 60399

With flange

Material: PET GF

Weight: 16.7/17 g, unit: 500 pcs.

Type: 83173

Ref. No.: 103570 white

Ref. No.: 103569 black

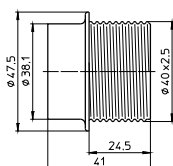

Caps

Material: PA GF

Profiled hole: \varnothing 10.5x8.6 mm

Fixing holes for screws M4

Height: 13.8 mm

Weight: 5.6/6 g, unit: 500 pcs.

Type: 96148

Ref. No.: 109188 white

Ref. No.: 109187 black

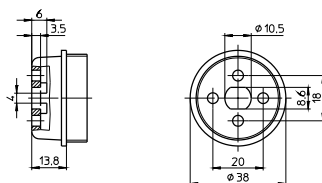

Caps

Material: PA GF

Female nipple: M10x1

Height: 17 mm

Weight: 9.8/10.1 g, unit: 500 pcs.

Type: 83007

Ref. No.: 109052 white

Ref. No.: 109039 black

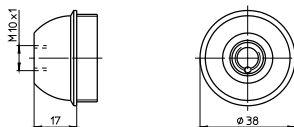

Caps with earth terminal

Material: PA GF

Female nipple: M10x1

Height: 17 mm

Weight: 10.7/11 g, unit: 500 pcs.

Type: 83035

Ref. No.: 109098 white

Ref. No.: 109099 black

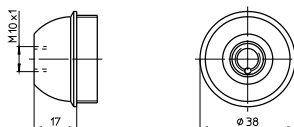

Lampholders for General-service Incandescent

Caps

Material: PA GF
 Moulded thread: M10x1
 Rotation stop: external
 Height: 17 mm
 Weight: 6.7/7 g, unit: 500 pcs.
 Type: 96147

Ref. No.: 109195 white

Ref. No.: 109196 black

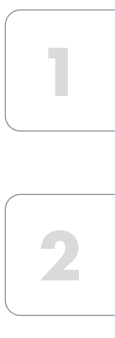
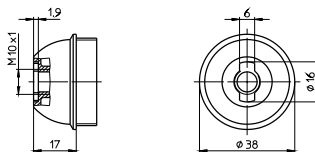

Caps

Material: PA GF
 Moulded thread: M10x1
 Rotation stop: external
 With locking screw
 Height: 17 mm
 Weight: 7.1/7.3 g, unit: 500 pcs.
 Type: 83293

Ref. No.: 109087 white

Ref. No.: 109074 black

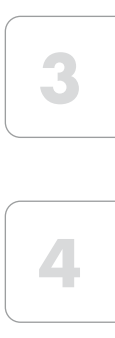
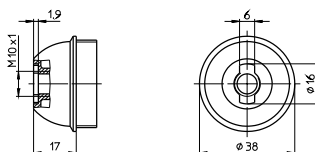

Caps

Material: PA GF
 Round hole: Ø 10.5 mm
 Rotation stop: internal and external
 Height: 17 mm
 Weight: 5.9/6.6 g, unit: 500 pcs.
 Type: 96154

Ref. No.: 109190 white

Ref. No.: 109191 black

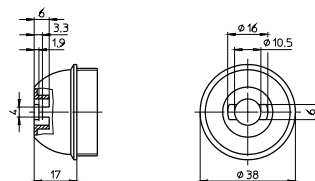

Caps

Material: PA GF
 Profiled hole: Ø 10.3 mm
 Rotation stop: internal and external
 Height: 17 mm
 Weight: 5.9/6.6 g, unit: 500 pcs.
 Type: 96124

Ref. No.: 109559 white

Ref. No.: 109512 black

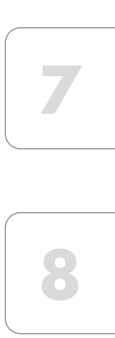
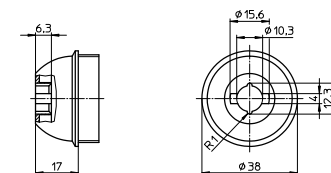

Caps

Conical shape
 Material: PA GF
 Female nipple: M10x1
 Height: 19.2 mm
 Weight: 14.2/15.2 g, unit: 500 pcs.
 Type: 83274

Ref. No.: 109081 white

Ref. No.: 109093 black

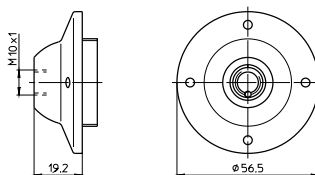

Lampholders for General-service Incandescent

Caps

Conical shape

Material: PA GF

Round hole: \varnothing 10.5 mm

Rotation stop: internal

Height: 19.2 mm

Weight: 10.4/10.6 g, unit: 500 pcs.

Type: 96172

Ref. No.: 109060 white

Ref. No.: 109044 black

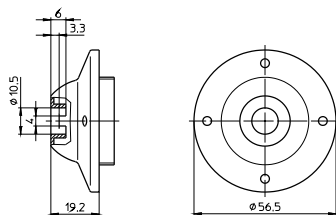

E27 Porcelain Lampholders

For incandescent lamps with base E27

E27 lampholders, one-piece
 Material: porcelain, white, T270
 Nominal rating: 4/250/5 kV
 Screw terminals: 0.5–2.5 mm²
 Spring loaded central contact
 Fixing oblong holes for screws M4
 Weight: 60.6 g, unit: 250 pcs.
 Type: 62050

Ref. No.: 102599

Type: 62010 with lamp safety catch (with spring)

Ref. No.: 102577

Type: 62009 with lamp safety catch (with crushing)

Ref. No.: 544605

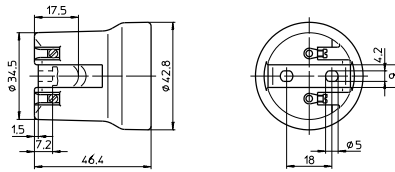

E27 lampholder, one-piece
 Material: porcelain, white, T270
 Nominal rating: 4/250/5 kV
 Screw terminals: 0.5–2.5 mm²
 Spring loaded central contact
 Fixing pillars for screws M3
 Weight: 66.3 g, unit: 250 pcs.
 Type: 62015

Ref. No.: 102582

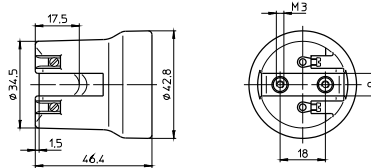

E27 lampholder, one-piece
 Material: porcelain, white, T270
 Nominal rating: 4/250/5 kV
 Screw terminals: 0.5–2.5 mm²
 Spring loaded central contact
 Fixing oblong holes for screws M4
 Weight: 60.5 g, unit: 200 pcs.
 Type: 62070

Ref. No.: 543304

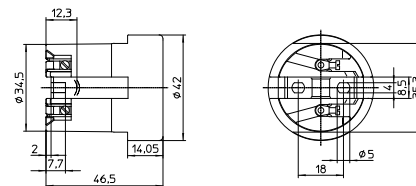

E27 lampholder, one-piece, for cover caps (see p. 186–188)

Material: porcelain, white, T270
 Nominal rating: 4/250/5 kV
 Screw terminals: 0.5–2.5 mm²
 Spring loaded central contact
 Fixing oblong holes for screws M4
 Weight: 66.5 g, unit: 250 pcs.
 Type: 62310

Ref. No.: 102624

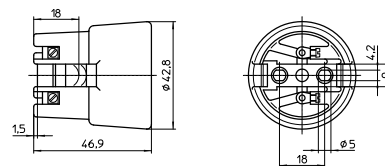

1

2

3

4

5

6

7

8

9

10

Lampholders for General-service Incandescent

E27 lampholder

Material: porcelain, white, T270

Nominal rating: 4/250/5 kV

Screw terminals: 0.5–2.5 mm²

Spring loaded central contact

Fixing holes for screw M4

Weight: 66.5 g, unit: 250 pcs.

Type: 62370

Ref. No.: 543303

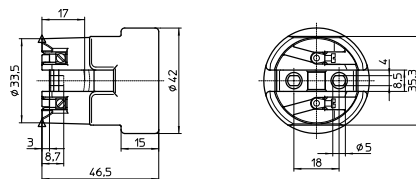

E27 lampholder, three-piece

Material: porcelain, white, T240, nominal

rating: 4/250, screw terminals: 0.5–2.5 mm²

Weight: 116/125/116/125/121.7/130.7 g

Unit: 25 pcs.

Type: 62061 female nipple: M10x1

Ref. No.: 535684

Ref. No.: 535685 with earth screw

Type: 62062 female nipple: M13x1

Ref. No.: 536451

Ref. No.: 536452 with earth screw

Type: 62063 female nipple: G3/8A

Ref. No.: 534832

Ref. No.: 534833 with earth screw

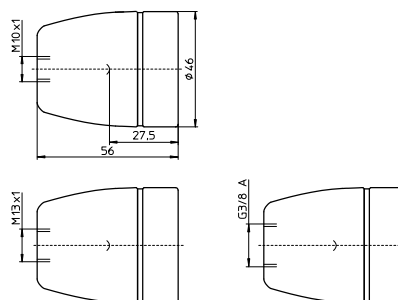

E27 Metal Lampholders, Three-piece

For incandescent lamps with base E27

Nominal rating: 4/250
 Type: 670 plain casing
 Type: 671 threaded casing 40x2.5
 Temperature marking: T240

Inserts

Material: porcelain, white
 Screw terminals: 0.5–2.5 mm²
 Spring loaded central contact, casing lock
 Weight: 22.8/23.3 g, unit: 500 pcs.
 Type: 83221

Ref. No.: 103595

Type: 83223 with earth terminal

Ref. No.: 103597

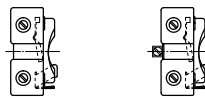

Plain casings

Material: zinc-coated polished steel
 Weight: 23.5/22.9/27.1/27.1g
 Unit: 500 pcs.
 Type: 83218 insulating threaded ring: PPS
Ref. No.: 103582 chrome-finish
Ref. No.: 103583 brass-finish
 Type: 83226 insulating threaded ring: steatite
Ref. No.: 504640 chrome-finish
Ref. No.: 504641 brass-finish

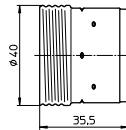

Threaded casings 40x2.5 IEC 60399

Material: zinc-coated polished steel
 Weight: 24/23.1/27.3/27.6 g
 Unit: 500 pcs.
 Type: 83219 insulating threaded ring: PPS
Ref. No.: 103590 chrome-finish
Ref. No.: 103591 brass-finish
 Type: 83227 insulating threaded ring: steatite
Ref. No.: 504643 chrome-finish
Ref. No.: 504644 brass-finish

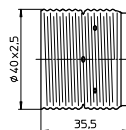

Caps

Material: zinc-coated polished steel
 Female nipple: M10x1
 Weight: 10.6/10.8/11.4/11.3 g
 Unit: 500 pcs.
 Type: 80342
Ref. No.: 103020 chrome-finish
Ref. No.: 103021 brass-finish
 Type: 80343 with earth terminal
Ref. No.: 103026 chrome-finish
Ref. No.: 103027 brass-finish

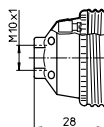
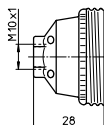

1

2



3

4



5

6



7

8



9

10

E27 Metal Pull-switch Lampholders

For incandescent lamps with base E27

Nominal rating: 2/250

Type: 55204 plain casing, with pull cord

Type: 55203 plain casing, with draw chain

Type: 55304 threaded casing 40x2.5, with pull cord

Type: 55303 threaded casing 40x2.5, with draw chain

Insert with pull cord

Material: porcelain, white

Screw terminals: 0.5–2.5 mm²

Length of cord: 250 mm, casing lock

Weight: 28 g, unit: 500 pcs.

Type: 83006

Ref. No.: 103504

End button for pull cord, material: PS, white

Weight: 0.8 g, unit: 500 pcs.

Type: 96010

Ref. No.: 105144

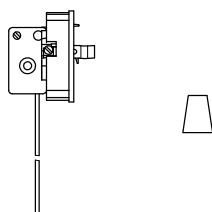

Insert for brass chain

Material: porcelain, white

Screw terminals: 0.5–2.5 mm²

Weight: 29.4 g, unit: 500 pcs.

Type: 83008

Ref. No.: 103515

Draw chain with end button

Material: brass, length of chain: 85 mm

Weight: 3.9 g, unit: 500 pcs.

Type: 94304

Ref. No.: 104928

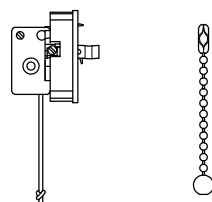

Casings

Material: brass, passivated

Insulating threaded ring: PPS

Weight: 21.5/22.7 g, unit: 500 pcs.

Type: 83218 plain casing

Ref. No.: 103587

Type: 83219 threaded casing 40x2.5

Ref. No.: 103594

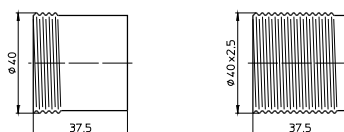

Cap with earth terminal

Material: brass, passivated

Female nipple: M10x1

With insulating insert

Weight: 20 g, unit: 500 pcs.

Type: 80014

Ref. No.: 102956

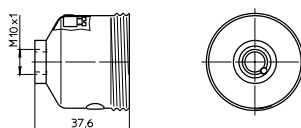

E27 Thermoplastic Rocker Switch Lampholders

For incandescent lamps with base E27

Nominal rating: 2/250

Temperature marking: T180

Suitable casings see page 189–190:

Type: 83000 plain casing

Type: 83002 threaded casing 40x2.5

Type: 83173 threaded casing 40x2.5, with flange

Inserts with switch

Material: PET GF, white

Screw terminals: 0.5–2.5 mm²

Weight: 11/11.1 g, unit: 500 pcs.

Type: 83015

Ref. No.: 107331 switch, white

Ref. No.: 107096 switch, black

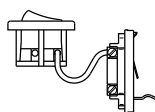

Caps

Material: PA GF

Female nipple: M10x1

Weight: 14.2/14.7 g, unit: 500 pcs.

Type: 83260

Ref. No.: 109198 white

Ref. No.: 109199 black

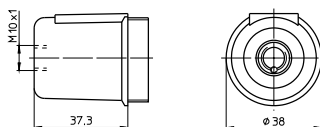

Caps

Material: PA GF

Profiled hole: Ø 10.4 mm

Rotation stop: internal and external

Weight: 8.2/10.4 g, unit: 500 pcs.

Type: 96229

Ref. No.: 109200 white

Ref. No.: 109201 black

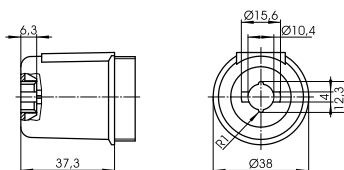

1

2

3

4

5

6

7

8

9

10



E27 Festoon Lampholders

For lighting chains of protection class II

Degree of protection: IP44

Type: 64710/11

The lampholders may only be operated with the lamp pointing downwards and with a gasket.

E27 festoon lampholder

For lamps max. 40 W

Material: PBT GF, black

Nominal rating: 4/250

Blade contacts

for festoon lead H05RN H2-F 2X1.5

To be used only with protection cap

Weight: 13.8 g, unit: 500 pcs.

Type: 83297

Ref. No.: 109158

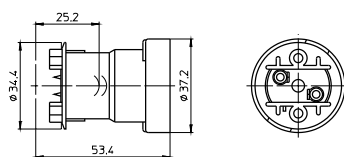

Protection cap

For E27 festoon lampholders

Material: PA GF, black

With ready-fitted stainless screws

Weight: 6.3 g, unit: 500 pcs.

Type: 83300 with non-removable screws

Ref. No.: 109243

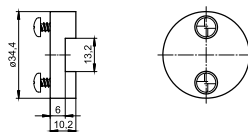

Protection cap

For E27 festoon lampholders

Material: PA GF, black

With ready-fitted stainless screws

Fixing holes for screws M4

Weight: 7.2 g, unit: 500 pcs.

Type: 83301 with non-removable screws

Ref. No.: 502515

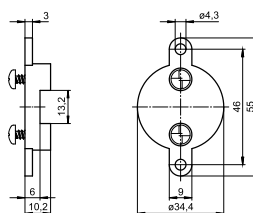

Gasket

For E27 festoon lampholders

Material: silicone

Weight: 4 g, unit: 500 pcs.

Type: 98006

Ref. No.: 106817

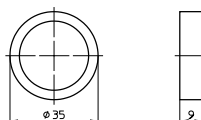

B22d Lampholders, Accessories

For mains voltage halogen incandescent lamps

B22d lampholders

For cover caps (see p. 186–188)

Nominal rating: 2/250

Push-in twin terminals: 0.5–1.5 mm²

Fixing holes for self-tapping screws
acc. to ISO 1481/7049-ST3.9-C/F

Weight: 12.7/12.3 g, unit: 500 pcs.

Type: 64800

Ref. No.: 108748 PET GF, T180, white

Ref. No.: 544621 PET GF, T210, white

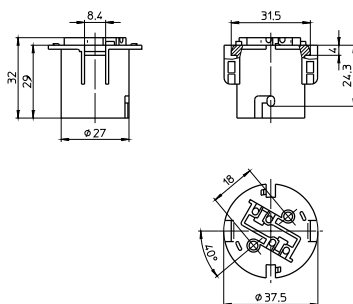

Plain casing

For B22d lampholders type 64800

For cover caps (see p. 186–188)

Threaded casing on request

Material: PA GF, white

Weight: 14.5 g, unit: 500 pcs.

Type: 96021

Ref. No.: 504749

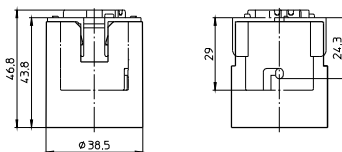

1

2

3

4

5

6

7

8

9

10

Accessories

For E14, E27 lampholders, one-piece and three-piece and B22d lampholders

The luminaire manufacturer is responsible for the right choice of accessories.
Brass-finished versions are available on request.

Plastic screw rings

For E14 lampholders
with external thread 28x2 IEC 60399
Weight: 3.6/3.2/1.8/1.6 g, unit: 1000 pcs.
Type: 03210 Ø 43 mm, height: 15 mm

Ref. No.: 100125 PET GF, white

Ref. No.: 109162 PA GF, black

Type: 05202 Ø 34 mm, height: 7.5 mm

Ref. No.: 107154 PET GF, white

Ref. No.: 109166 PA GF, black

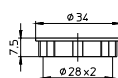
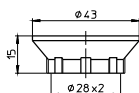

Metal screw ring

For E14 lampholders
with external thread 28x2 IEC 60399
Material: zinc-coated polished steel, chrome-finish
Ø 40 mm, height: 12 mm
Weight: 4.3 g, unit: 500 pcs.
Type: 06700

Ref. No.: 100194

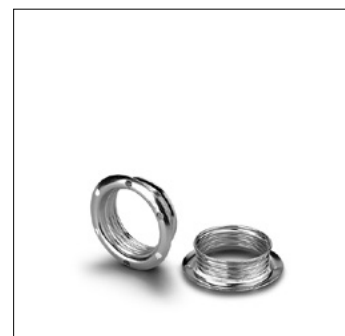
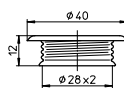

Front gasket

For E14 lampholders type 64308, 64360 and 64380
As lamp safety catch and for protection against moisture acc. to IEC 60079-15
Material: elastomer
Weight: 1.1 g, unit: 2000 pcs.
Type: 98013

Ref. No.: 534689



Plastic screw rings

For E27 and B22d lampholders
Weight: 4.9/4.4/3.3/3 g, unit: 500 pcs.
Type: 08610 Ø 55 mm, height: 15 mm

Ref. No.: 100270 PET GF, white

Ref. No.: 109285 PA GF, black

Type: 08701 Ø 47.8 mm, height: 9 mm

Ref. No.: 100273 PET GF, white

Ref. No.: 109291 PA GF, black

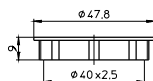
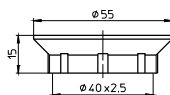

Lampholders for General-service Incandescent

Metal screw ring

For E27 and B22d lampholders

Material: zinc-coated polished steel, chrome-finish

Ø 56.5 mm, height: 13 mm

Weight: 7 g, unit: 500 pcs.

Type: 07400

Ref. No.: 100217

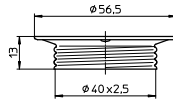

1

Brackets for E14 lampholders

For fastening with nipples 109249, 109247

Material: zinc-coated polished steel

Fixing holes for screws M3

Weight: 5.5/5.3 g, unit: 1000 pcs.

Type: 94068 internal bracket 90°

Ref. No.: 106767

Type: 94069 internal bracket 110°

Ref. No.: 106768

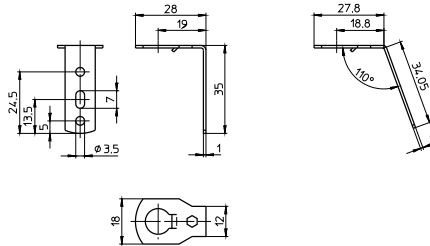

2

3

4

U-shaped clips

For E27 lampholders, one-piece

Material: zinc-coated polished steel, chrome-finish

For wall thickness: 0.5–2 mm

Weight: 3.7/4.3 g, unit: 2500 pcs.

Type: 94435

Ref. No.: 109621

Type: 80433 with earth terminal

Ref. No.: 103087

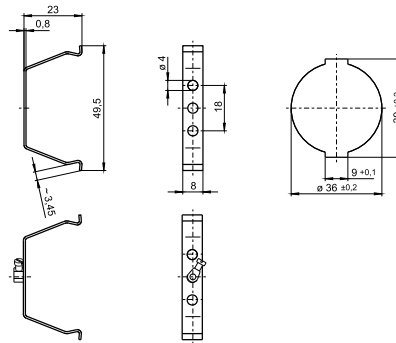

5

6

Brackets: 90°, 12.5x47.1 mm

For E14 and E27 lampholders, one-piece

Material: zinc-coated polished steel, chrome-finish

Fixing hole for screw M5

Weight: 5.6/4.8 g, unit: 500 pcs.

Type: 80475 with earth terminal

Ref. No.: 400779

Type: 94444

Ref. No.: 401536

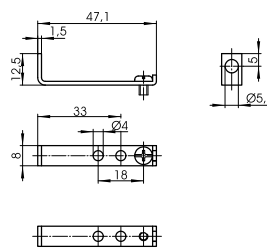

7

8

Brackets: 100°, 22.9x36.6 mm

For E14 and E27 lampholders, one-piece

Material: zinc-coated polished steel, chrome-finish

Fixing holes for self-tapping screws

acc. to ISO 1481/7049-ST2.9-C/F

Tapped hole M4

Weight: 5.5/4.6 g, unit: 1000 pcs.

Type: 80476 with earth terminal

Ref. No.: 400772

Type: 94438

Ref. No.: 401549

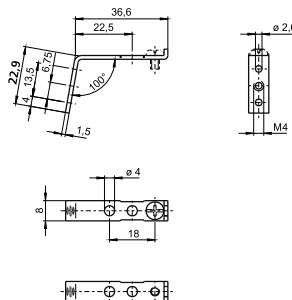

9

10

Lampholders for General-service Incandescent

Fixing bracket

For E14 and E27 lampholders, one-piece
 Material: zinc-coated polished steel, chrome-finish
 With slots for screws M4
 Weight: 4.6 g, unit: 1000 pcs.
 Type: 94450

Ref. No.: 106829

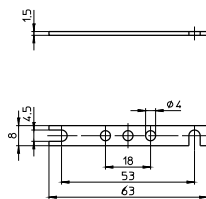

Fixing brackets: 8°, 14.5x39 mm

For E27 thermoplastic lampholders, one-piece
 Material: PET GF, white
 With cable holder
 Oblong hole for screw M4
 Weight: 3/3.6 g, unit: 1000 pcs.
 Type: 97750 fixing holes: Ø 4 mm

Ref. No.: 109725

Type: 97752 fixing holes for self-tapping screws acc. to ISO 1481/7049-ST3.9-C/F

Ref. No.: 109728

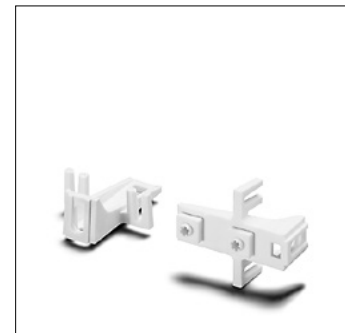
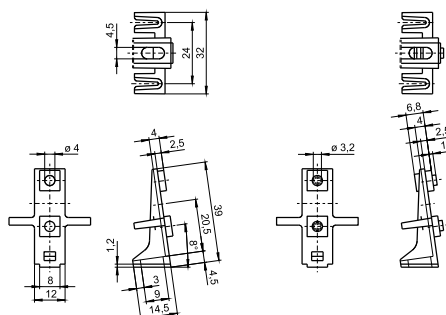

Nipples

For E14 cover caps with moulded thread: M10x1
 Cross groove for rotation stop: external
 For E27 caps (see p. 190–192)
 Material: PA, white
 Male nipple: M10x1, with hexagon flange
 Weight: 0.5 g, unit: 1000 pcs.
 Type: 09700/09703/09708
Ref. No.: 538089 length: 15 mm
Ref. No.: 109249 length: 10 mm
Ref. No.: 109247 length: 7 mm

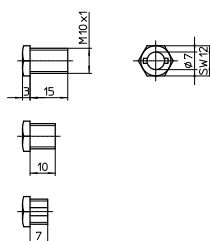

Locking nut for thread M10x1

Material: PA GF
 Weight: 0.9 g, unit: 1000 pcs.
 Type: 97267
Ref. No.: 507797 white
Ref. No.: 507798 black



Cord grip with insulating socket

For E14 and E27 lampholders
 Material: PA, natural
 For luminaires of protection class II
 For leads H03VVH2-F 2X0.75
 Weight: 0.6 g, unit: 1000 pcs.
 Type: 97632
Ref. No.: 534097

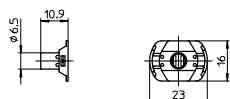

Lampholders for General-service Incandescent

Cable grips

For leads H03VV-F and H03VVH2-F 2X0.5

or 2X0.75

Material: PA

Male nipple: M10x1, length: 11 mm

With locking screw

Weight: 1.6/1.5 g, unit: 1000 pcs.

Type: 09701

Ref. No.: 109248 white

Ref. No.: 109253 black

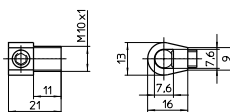

1

2

Cord grip

For E14 lampholders, three-piece,

with cap height: 19 mm

For leads H03VVH2-F

Material: PA, black

Weight: 0.6 g, unit: 1000 pcs.

Type: 09501

Ref. No.: 106948



3

4

Cord grip

For E27 lampholders, three-piece (without switch)

For leads H03VVH2-F

Weight: 0.9 g, unit: 1000 pcs.

Type: 09502

Ref. No.: 106949 PA, black

Insulating socket

Material: PA, transparent

Weight: 0.5 g, unit: 1000 pcs.

Type: 09705

Ref. No.: 109592

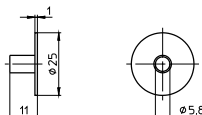

5

6

Cord grips

For leads H03VV-F 2X0.5 or

H03VV-F 2X0.75

Material: PA

Weight: 0.9/0.8/1.7/1.6 g, unit: 1000 pcs.

Type: 09606 cord grips

Ref. No.: 506026 white

Ref. No.: 506027 black

Type: 96160 screw caps

Ref. No.: 109318 white

Ref. No.: 109317 black

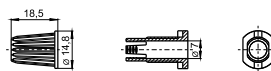

7

8

Insulating socket for E14 lampholders

Material: PA, transparent

Weight: 1 g, unit: 1000 pcs.

Type: 09704

Ref. No.: 109600

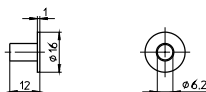

9

10

E40 Porcelain Lampholders

For incandescent lamps with base E40

Nominal rating: 18/500/5 kV

Screw terminals: 1.5–4 mm²

Spring loaded central contact

E40 lampholders

Material: porcelain, white, T270

Oblong holes for screws M5

Weight: 224/229.3/224/229.3 g

Unit: 48 pcs.

Type: 12800/12801

Ref. No.: 108208

Ref. No.: 107780 with lamp safety catch

With steel thread

Ref. No.: 532602

Ref. No.: 532603 with lamp safety catch

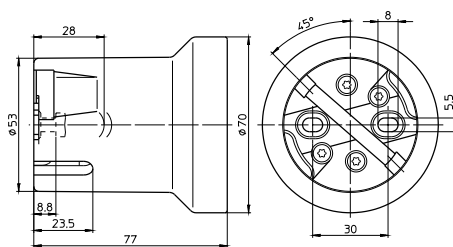

E40 lampholders

Material: porcelain, white, T270

Fixing bracket with slots for screws M5

Weight: 252.3/243/252.3/243 g

Unit: 48 pcs.

Type: 12810/12811

Ref. No.: 108374

Ref. No.: 108375 with lamp safety catch

With steel thread

Ref. No.: 532604

Ref. No.: 532605 with lamp safety catch

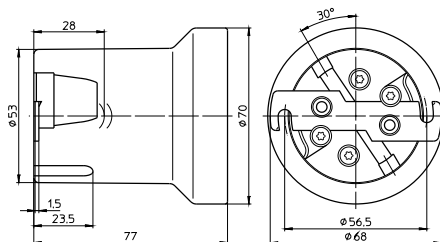

E40 lampholders

Material: porcelain, white, T270

Fixing bracket with tapped holes for screws M5

With lamp safety catch

Weight: 252.8 g, unit: 48 pcs.

Type: 12812

Ref. No.: 108373

With steel thread

Ref. No.: 532606

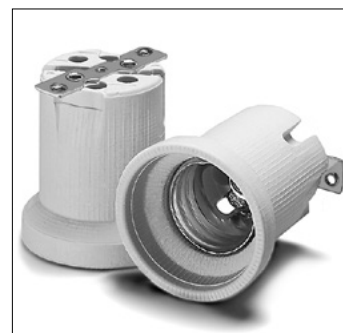
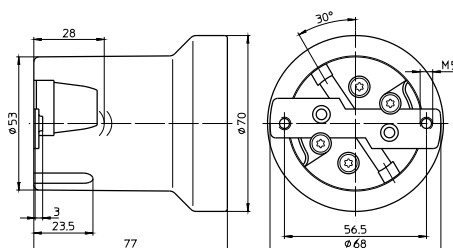

1

2

3

4

5

6

7

8

9

10

5

Components for Incandescent Lamps

Transformers and converters for low-voltage halogen lamps	207
Dimmability of transformers and converters	208
Electronic converters	208-212
Assembly instructions	209-212
Conductors for low-voltage halogen installations	213
Lampholders for incandescent lamps	214-215
Retrofit Lamps	215
General technical details	228-236
Glossary	237-239

Transformers and converters for low-voltage halogen lamps

Operating low-voltage halogen lamps depends on operating devices that transform the usual mains voltage of 230 V to under 24 V. Safety transformers, of either electromagnetic or electronic (converter) design, have been in almost exclusive use for several years now. The type plate of electromagnetic transformers bears the symbol for safety transformers in accordance with VDE 0570, corresponding to EN 61558. Electronic converters are marked with the sign for Safety Extra-Low Voltage (SELV), which indicates that the product is an isolating converter whose secondary output is safe to touch even during no-load operation.

All Vossloh-Schwabe transformers are safety transformers, i.e. isolation transformers for supplying SELV (safety extra-low voltage) and PELV (protection extra-low voltage) circuits. With such systems, the voltage must not exceed a value of 50 V AC or 120 V DC (smoothed) between the conductors or a conductor and the earth conductor of a circuit that is separated from the mains by a safety transformer. The specified values apply for protected (non-touchable) voltages; 25 V AC and 60 V DC (smoothed) apply for exposed (touchable) voltages.

Depending on their design features to protect against touchable live parts, transformers and converters fall into one of two protection classes. Operating devices of protection class I are base-insulated and have a protective earth conductor connection terminal that must be connected to the protective earth conductor for safety reasons. Isolating transformers and converters of protection class II are equipped with double or reinforced insulation that protects against dangerous casing currents; these operating devices are solely available as independent operating devices (also see page 233; Protection Classes of Luminaires and Operating Devices).

Electronic converters can also be fitted with a functional earth terminal that must be connected to a functional earth to ensure compliance with EMC requirements. In addition, some electronic converters are designed in such a way that neither a protective earth conductor nor a functional earth needs to be connected.

Operating devices can also be differentiated according to the way they are used. Built-in transformers have to be installed in a permanent casing, e.g. a luminaire. In contrast, so-called independent transformers and converters can be operated independently of a luminaire. These are often found in ceiling installations; in order to prevent possible noise development, isolation transformers must be mounted in such a way as to avoid vibration transmission.

Transformers or converters bearing the MM mark can be mounted on surfaces of unknown flammability, which can be the case when mounting these devices on wooden furniture elements. Such devices comply with the temperature requirements of VDE 0710, part 14, of < 95 °C during normal and < 115 °C during abnormal operation.

Converters are labelled with a t_c point. The stipulated temperature (e.g. 75 °C) must not be exceeded when installed so that the service life of the converter is not shortened. The temperature quoted in the triangle (e.g. 110) denotes that the surface of the converter must never (even in the event of a defect) exceed this temperature.

Protection symbols



Safety transformer

SELV

Safety Extra Low Voltage



Protection class II



Independent operating device



Furniture installation
Normal operation < 95 °C
Abnormal operation < 115 °C

If the maximum value of 130 °C is not exceeded, the luminaire does not have to be tested in accordance with ∇ conditions.



$t_c = 75 \text{ °C}$
Measuring point for maximum permissible casing temperature



Temperature-protected converter
(in this case < 110 °C)

1

2

3

4

5

6

7

8

9

10

Dimmability of transformers and converters

Electromagnetic transformers can be controlled using phase-cutting leading-edge dimmers. These dimmers "cut" the sinusoidal mains voltage in the negative and positive half wave at an angle in the ascending portion of this sinusoidal half wave. The higher the angle is set at the dimmer controls, the lower the effective value of the voltage and hence the lamp's output.

Electronic converters can be controlled using phase-cutting trailing-edge dimmers. In this case, a semiconductor ensures the predefined descending portion of the sinusoidal half wave is clipped, i.e. the voltage is reduced in reverse mode. Again, higher the angle is set at the dimmer controls, the lower the effective value of the voltage and hence the lamp's output.

Converters of the LiteLine (EST 60/12.635, EST 70/12.380, EST 105/12.381 and EST 150/12.622) families can be operated using conventional phase-cutting trailing-edge and phase-cutting leading-edge dimmers.

Electronic Converters

The safe operation of electronic converters is dependent on the maximum permissible temperature not being exceeded at the measuring point. Vossloh-Schwabe has determined a casing temperature measuring point – $t_{c \text{ max.}}$ – on all converter casings. To avoid shortening the service life or diminishing operating safety, the stipulated maximum temperature must not be exceeded at this t_c point. This point is determined by testing the converter during normal, IEC-standardised operation at the specified max. ambient temperature (t_a), which is also indicated on the type plate. As both the design-related ambient temperature and the converter's inherent heat generation, as determined by the installed load, are subject to great variation, the casing temperature should be tested at the converter's t_c point under real installation conditions.

Temperature-protected converters feature a further protection symbol, namely a triangle containing the maximum temperature. This symbol certifies that the stipulated surface temperature of the device casing will not be exceeded during any operating state or in the event of a defect.

Vossloh-Schwabe electronic converters are tested in accordance with EN 61347. Function tests are carried out in accordance with EN 61047. VS converters can be operated without causing any inadmissible system reactions as all devices comply with EN 61000-3-2 on the limitation of mains harmonics. They also meet the EMC requirements of EN 61547. These devices are thus also protected against mains surges (as defined in the standard) that can be caused by, for instance, inductive ballasts during combined operation of fluorescent and low-voltage halogen lamps.

In addition, all devices comply with the RFI requirements of EN 55015. As the highly effective integrated filter can only limit the unit's own interference, the secondary conductor should be kept to under 2 metres in length so as to avoid RFI interference in the lighting system.

Dimmable using phase-cutting leading-edge or trailing-edge dimmers



Dimmable using phase-cutting leading-edge dimmers



Dimmable using phase-cutting trailing-edge dimmers



Working principle of a phase-cutting leading-edge dimmer

α = Ignition angle
 λ = Operating angle
 U = Voltage
 I = Current

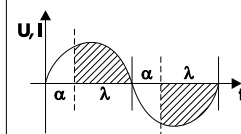

Working principle of a phase-cutting trailing-edge dimmer

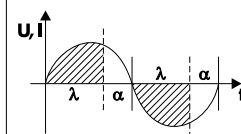

Assembly Instruction for Electronic Converters

For mounting and installing electronic converters for low-voltage halogen lamps

Mandatory regulations

DIN VDE 0100	Erection of low voltage installations
EN 60598-1	Luminaires – part 1: general requirements and tests
EN 61000-3-2	Electromagnetic compatibility (EMC) – part 3: maximum values – main section part 2: maximum values for mains harmonics (device input current up to and including 16 A per conductor)
EN 55015	Maximum values and methods of measurement for RFI suppression in electrical lighting installations and similar electrical appliances
EN 61547	Installations for general lighting purposes – EMC immunity requirements
EN 61347-1	Operating devices for lamps – part 1: general and safety requirements
EN 61347-2-2	Operating devices for lamps – part 2-2: special requirements for DC- or AC-powered electronic converters for incandescent lamps
EN 61047	DC- or AC-powered electronic converters for incandescent lamps – performance requirements

Designations for VS converters

Designations for electronic converters are first listed by the name of the product family, which in each case reflects the visible product properties. The type designation should be read as follows:

EST	60	/12	.388
Electronic safety transformer	Max. wattage	Lamp voltage	Serial number

Mechanical mounting

Mounting position Any

Clearance Min. of 0.1 m from walls, ceilings, insulation; min. of 0.1 m from other electronic converters; min. of 0.25 m from sources of heat (lamp)

Surface Solid; device must not be allowed to sink into insulation materials

Mounting location In dry rooms or in luminaires, cases, casings or similar in the instance of built-in converters

Fastening Independent converters: using screws, \varnothing 4 mm

Heat transfer If the electronic converter is destined for installation in a luminaire, sufficient heat transfer must be ensured between the converter and the luminaire casing. During operation, the t_c point must not exceed the specified value.

1

2

3

4

5

6

7

8

9

10

Technical specifications

Type		Operating voltage range AC	Dimmability		Temperature protection	Through-wiring ³	Type of automatic cut-out and number of possible VS devices			
			Unsuitable for DC operation	Phasecutting trailing edge ¹			Phasecutting leading edge ¹	Electronic control ²	Converter quantity	B (10A)
Liteline	EST 70/12.380	230–240	x	x	x	—	28	45	28	45
	EST 105/12.381	230–240	x	x	x	—	20	32	20	32
	EST 150/12.622	230–240	x	x	x	—	14	23	14	23
...Mini	EST 60/12.635	220–240	x	x	x	—	35	56	35	56

- ¹ The dimmer is connected to the primary side between mains and converter.
It is possible to connect several converters to one dimmer (whereby the dimmer's minimum and maximum load must be observed).
The dimmer-converter system should be subjected to function and noise development tests prior to installation.
- ² The rating is decreased electronically in the event of overheating.
- ³ Distributed secondary leads are only permitted on non-metallic surfaces (RFI suppression)

Properties of electronic converters

- Overheating** Protection against overheating is provided by an electronic controller (see table above).
- Short-circuit** The converter will be electronically disconnected in the event of a short-circuit at the output; once the short-circuit has been eliminated, the converter will switch on again automatically.
- Overload** Minor overloads (< 50%) will trigger the temperature switch against overheating; major overloads (> 50%) will trigger the same reaction as for short-circuit.

Should any of the above-mentioned safety functions be triggered, disconnect the converter from the power supply, then find and eliminate the cause of the problem.

Protection against transient mains peaks
Values compliant with EN 61547 (immunity)

Electrical installation

Conductors Primary conductor cross-section: min. 0.75 mm²
Secondary conductor cross-section: min. 0,75 mm² for 50 W output and min. 1 mm² for 100 W output

Stripping

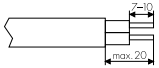
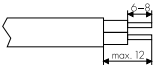
Converter	EST 60/12.635	EST 70/12.380, EST 105/12.381, EST 150/12.622
Type of lead	All usual types of lead up to 4 mm ²	H03-WH2-F 2X0,75 / H05-VH2-F 2X0,75 / H03-V-F 2X0,75 / H05-V-F 2X0,75
Lead preparation		

Connections Screw terminals: max. initial torque of 0.4 Nm must not be exceeded

Secondary length Min. 0.25 m (clearance to lamp), max. 2 m (RFI protection)

Secondary wiring Min. 0.1 m clearance from the mains (RFI protection)

Star wiring Twist single-wire or lead wires narrowly; silicone-insulated leads are recommended

Parallel connection Secondary-side parallel connection is inadmissible

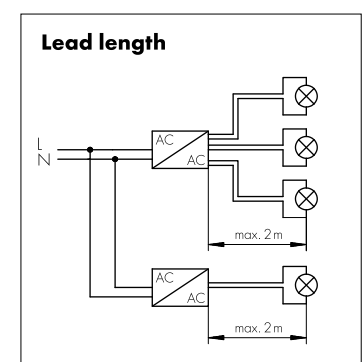
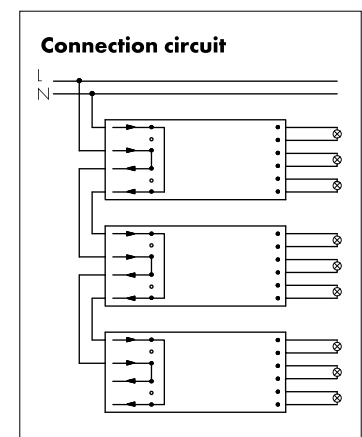

Feed-through of the mains voltage

See table on page 210

Distributed secondary leads are only permitted on non-metallic surfaces (RFI suppression)

Selection of automatic cut-outs for VS converters

Dimensioning automatic cut-outs

High transient mains current pulses occur when a converter is switched on because the capacitor has to load. As the lamps ignite almost simultaneously, this also creates a high power drain. The high currents that occur when the system is switched on put a strain on the automatic conductor cut-outs, which must be selected and dimensioned to suit.

Release reaction Release reaction of automatic cut-outs in accordance with VDE 0641, Part 11; for B and C characteristics. The values provided in the table on page 210 are meant as guidelines only and may vary depending on the respective lighting system.

No. of converters The maximum number of VS converters (see table on page 210) applies to cases where the devices are switched on simultaneously. Specifications apply to single-pole fuses. The number of permissible ballasts must be reduced by 20% for multi-pole fuses. The considered circuit impedance equals 400 mΩ (approx. 20 m [2.5 mm²] of conductor from the power supply to the distributor and a further 15 m to the luminaire).

Dimmability of electronic converters

Dimmed operation

VS converters can be operated with phase-cutting trailing-edge and leading-edge dimmers. The dimmer is connected to the primary side between mains and converter. It is possible to connect several converters to one dimmer (whereby the dimmer's minimum and maximum load must be observed). The dimmer-converter system should be subjected to function and noise development tests prior to installation.

Electromagnetic compatibility (EMC)

Mains Harmonics

Maximum values are observed in accordance with EN 61000-3-2.

Interference

The requirements of EN 55015 must be met for luminaires with converters for operating low-voltage halogen lamps.

Vossloh-Schwabe converters are designed and manufactured to ensure these requirements are satisfied provided the installation instructions regarding the interference voltage at the connection terminals and electromagnetic interference fields up to 300 MHz are observed.

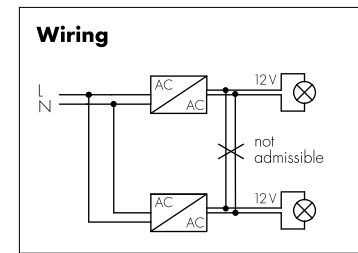

1

2

3

4

5

6

7

8

9

10

Additional information

Wiring	<p>To ensure good radio interference suppression and the greatest possible operating safety, the following points should be observed when installing electronic converters:</p> <ul style="list-style-type: none">• Conductors between the EST and the lamp (HF conductors) must be kept short (reduction of electromagnetic interference).• Mains and lamp conductors must be kept separate and if possible should not be laid in parallel to one another. The distance between HF conductors and mains conductors should be as large as possible, ideally > 5 cm. (This prevents the induction of interference between the mains and lamp conductors).• The mains conductor within the luminaire must be kept short (to reduce the induction of interference).• The mains conductor must not be laid too close to the EST (this is especially important in the event of through-wiring).• Mains and lamp conductors must not be crossed. Should this be impossible to avoid, conductors should be crossed at right angles to one another (to avoid inducing interference between mains and HF conductors).• Should conductors be wired through metal parts, such conductors must always be additionally shielded (e.g. with an insulating sleeve or grommet).
Temperature	<p>Reference point temperature t_c</p> <p>The safe operation of electronic converters is dependent on the maximum permissible temperature not being exceeded at the measuring point. Vossloh-Schwabe has determined a casing temperature measuring point – $t_{c \max}$. – on all converter casings. To avoid shortening the service life or diminishing operating safety, the stipulated maximum temperature must not be exceeded at this t_c point. This point is determined by testing the converter during normal, IEC-standardised operation at the specified ambient temperature (t_a), which is also indicated on the type plate. As both the design-related ambient temperature and the converter's inherent heat, as determined by the installed load, are subject to great variation, the casing temperature should be tested at the t_c point under real installation conditions.</p> <p>Ambient temperature t_a</p> <p>The ambient temperature – as specified on every converter – denotes the permissible temperature range within the luminaire or at the place of installation.</p>
Reliability	<p>Service life of 50,000 hrs at reference point temperature t_c, whereby a switching cycle of 165 minutes on and 15 minutes off is assumed. Failure rate: $\leq 0.2\%/1,000$ hrs</p> <p>In order to achieve the average service life, the maximum temperature ($t_{c \max}$) must not be exceeded at the t_c point.</p>
Emergency lighting	<p>VS electronic converters cannot be used for emergency lighting purposes as they are unsuitable for DC voltage operation.</p>

Conductors for low-voltage halogen installations

Conductors for installations with low-voltage halogen lamps

As the high temperatures associated with the operation of low-voltage halogen lamps place severe demands on lampholder conductors, a skilful combination of conductor and insulation is essential. Tin-plated copper conductors with silicone insulation are recommended for temperatures of up to 180 °C at the cable's conductor; nickel-plated copper cables with polytetrafluoroethylene (PTFE) sheathing are recommended for temperatures of up to 250 °C. Welded connections ensure the most effective heat discharge. Control measurements should be carried out if other connection types are used, e.g. crimping or plug connectors. To prevent the risk of additional heat generation, the maximum permissible current load must be observed when dimensioning the conductor cross-section. When using electromagnetic transformers, the conductor resistance causes a relatively large voltage drop. This drop in voltage is always associated with a reduction of luminous flux. For instance, an 11% drop in voltage will lead to a 30% drop in luminous flux. For this reason, care should be taken to ensure secondary conductors are kept as short as possible and conductor cross-sections are adequately dimensioned when wiring luminaires. Nevertheless, transformers should not be mounted too near the light source (> 25 cm clearance if possible) to prevent the heat generated by the lamp from raising the ambient temperature above the critical level for a transformer.

As electronic converters operate at high frequencies, consideration must be taken of the skin effect, i.e. the displacement of the electrons from the middle of the conductor to its surface. As a result, the full cross-section of the conductor is no longer used, resistance increases and thus leads to a greater drop in voltage. In addition, AC resistance, which is caused by feed line inductance, can result in an even greater voltage drop. It is therefore recommended that lamp conductors be laid closely parallel or twisted together.

Voltage losses (V) with a two-metre secondary conductor

Working frequency	Load W	Cross-section/Voltage drop		
		0.75 mm ²	1 mm ²	1.5 mm ²
50 Hz (electromagnetic transformers) any wiring layout	50	0,38 V	0.29 V	0.2 V
	100	0.74 V	0.56 V	0.39 V
40 kHz (electronic converters) any wiring layout (loops)	50	1.4 V	1.25 V	1.2 V
	100	3.3 V	3.1 V	3 V
40 kHz (electronic converters) wires twisted together or closely parallel	50	0.5 V	0.45 V	0.35 V
	100	1.2 V	1 V	0.85 V

Conductors for installations with halogen lamps

All conductors must be selected to suit the luminaire conditions (see table) in terms of material, cross-section and insulation. Testing these conductors under worst case conditions is essential as the commonly occurring high temperatures considerably reduce the conductivity of the conductor and hence its current-carrying capacity.

Insulation	Conductor Material	Cross-section mm ²	Mains voltage V	Max. temperature °C
SI	Cu tin-plated (Cu vz)	0.75	300	180
FEP	Cu tin-plated (Cu vz)	0.75	300	180
PTFE	Cu nickel-plated (Cu vn)	0.75	500	250
PTFE	Cu nickel-plated (Cu vn)	1	500	250
PTFE	Ni	1	500	250
PTFE	Ni	1.5	500	250

Conductor Contacts

Pin contact Ø 1

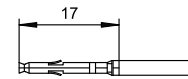

Socket connector

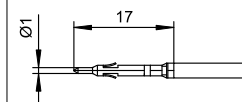

Flat connector 6.3x0.8

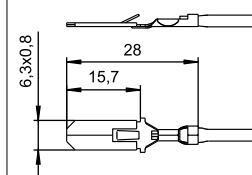

Cable with ferrules

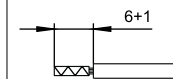

Cable, notched at 6 mm

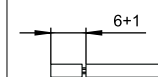

Cable, bared at 6 mm

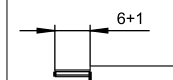

Ultrasonically welded cable end

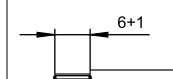

1

2

3

4

5

6

7

8

9

10

Lampholders

For low-voltage halogen lamps

With the exception of B15d bases, the low-voltage sector is dominated by pin bases, which are fitted with a variety of different pin distances and diameters.

Apart from classic lampholders that ensure both the electrical contact and the correct positioning of the lamp, connection elements are also available. These components are solely responsible for establishing electrical contact and are used in cases where, for instance, the regulations demand that the lamp be attached to its reflector (e.g. cold-light reflector lamps with GZ4 and GX5.3 bases).

Extremely high temperatures are also generated when operating low-voltage halogen lamps as a result of the tungsten-halogen cycle and high lamp currents. In addition, the respective luminaires are often of very compact design, which leads to heat accumulation and thus to high internal temperatures. The materials the lampholder is made of thus play a vital role for the luminaire's operating safety and the lamp's service life. In addition to tried-and-tested materials – ceramics for casings and mica for covers – ever more frequent use is being made of highly heat-resistant plastics like LCP (liquid crystal polymer for e.g. G4, GU4, GX5.3, GU5.3 and GY6.35 lampholders) and PPS (polyphenylene sulphide for G4 lampholders). Plastic lampholders provide clear advantages: narrow dimensional tolerances, no material fractures, low weight and clip-attachment options.

The type of contact also plays an important role. Conventional contacts are only attached to one side of the lamp pin. In contrast, additional contact points – known as multipoint contacts – lead to a reduction of current density at the point of transition from the lamp pins to the lampholder contact and with that to a decrease in temperature. These contacts provide the further advantage of ensuring superior heat dissipation from the lamp pins to the conductor. The temperature advantage of multipoint contacts in defined conditions (including welded-on conductors) can amount to as much as 100 °C. In extremely rare cases, due to the high internal pressure in the bulb, it is possible for the lamp to shatter. For reasons of fire prevention (high temperature of the glass bulb), the lamp's components must be prevented from falling out. Enclosed luminaires meet these requirements. Open luminaires, however, may only be operated using lamps with enclosed bulbs or low-pressure lamps. Lamps of this kind are suitably marked with pictograms on the lamp's packaging and in the lamp manufacturer's documentation. Lamps marked with pictogram No. 1 are suitable for use with open luminaires, whereas those marked with pictogram No. 2 may only be used in enclosed luminaires.

Lampholders for low-voltage halogen lamps are equipped with mounted cables or with plug-type connectors. In addition to the various lampholders contained in the catalogue, further lampholder models with various cable lengths and of various qualities as well as lampholders with plug-connected cables can be made available on request.

VS lampholders for the UL market and UL approved leads are available for all common lamp types.

Further information can be found at www.unvlt.com/products/legacy/lampholders.

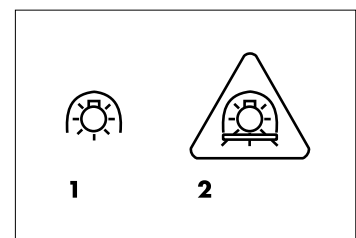

Bases of the most widely used low-voltage halogen lamps

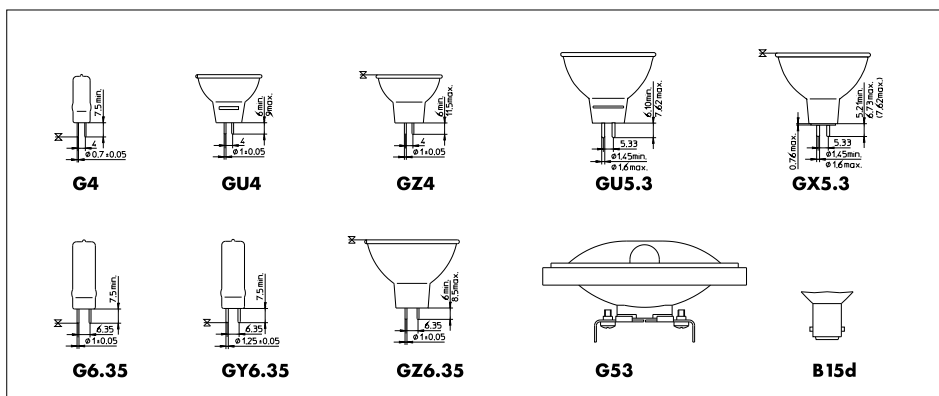

Lampholders for mains voltage halogen lamps

A major factor in lampholder design is the lamp temperature, which is determined by the tungstenhalogen cycle, high lamp current and high wattages. Lampholder casings can be made of ceramics, metal or the ever more popular highly heat-resistant thermoplastics like PET (polyethyleneterephthalate), PPS (polyphenylene sulphide) and LCP (liquid crystal polymer). The most suitable contact materials for these temperatures are nickel, copper-nickel alloys or copper materials with sufficiently thick nickel coatings. For tubular lamps (R7s base), the standard IEC 60061-2 7005-53 prescribes the respective contact pressure of lampholder contact materials.

Although halogen lamps offer twice the service life of general-purpose light bulbs, this can only be fully realised if luminaire manufacturers observe the recommended maximum temperatures at the lamp's pinch point. There is usually a welded-on molybdenum plate at the pinch point where the lamp base pins join the lamp filament. Lamp manufacturers ascertain the pinch temperature at this point, which is generally located within the lamp's quartz glass, using specially prepared measuring lamps. The pinch temperature is a critical thermal reference point which must not be exceeded within the luminaire.

VS lampholders for the UL market and UL approved leads are available for all common lamp types.

Further information can be found at www.unvlt.com/products/legacy/lampholders.

The bases of the most widely used mains voltage incandescent lamps

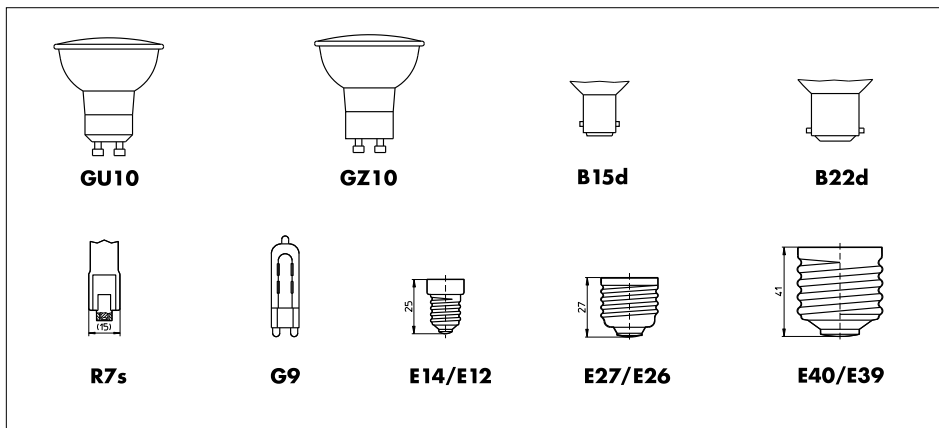

Retrofit Lamps

So-called retrofit lamps have been introduced to the market thanks to LED technology. Some of these can significantly exceed the weight of the original lamp.

When using such lamps in luminaires already introduced to the market (with conventional lampholders), but also for new luminaire designs (with conventional lampholders), this can cause a greater risk with regard to disconnecting the power supply and, in addition, can lead to greater mechanical damage.

1

2

3

4

5

6

7

8

9

10

6–80 W EMERGENCY LIGHTING MODULES



EMERGENCY LIGHTING

Emergency lighting systems spring to life any time normal artificial lighting systems fail. Emergency lighting is designed to ensure that work can continue without risk, that staff can safely leave any workplaces involving special hazards and that there is sufficient lighting to illuminate rescue paths/routes as well as to avoid panic situations.

As power cuts result in a risk to safety, legislation has been enacted in the form of the Health and Safety at Work Directive (Europe) and the Health and Safety at Work Acts of the individual European countries (e.g. Germany), all of which stipulate that emergency lighting must be provided. The requirements placed on emergency lighting installed in places of public assembly and public buildings are governed by supplementary directives and laws.

Vossloh-Schwabe's emergency lighting units are designed for use with T5, T8 and compact fluorescent lamps and can be operated with electromagnetic or electronic ballasts.

VS emergency lighting units are suitable for both continuous and standby circuits with a nominal operating period of 1 or 3 hours.

6

Emergency Lighting Modules for TC and T Lamps

Emergency lighting modules with self-diagnosis function

218–219

Technical details for emergency lighting modules

220–226

General technical details

228–236

Glossary

237–239

1

2

3

4

5

6

7

8

9

10

Emergency Lighting Modules 6 to 80 W with Self-Diagnosis Function

EMXs – Emergency lighting modules

For one-, two-, three- or four-lamp operation with standard and dimmable electronic or magnetic ballasts

EB phase is switched off during emergency operation

Short circuit protection

RoHS-compliant (excluding rechargeable batteries)

5-pin technology and therefore EMC-compliant even during emergency operation

Suitable for protection class I

EN 61347-1, EN 61347-2-7

Suitable for systems in accordance with VDE 0108 or EN 50172

Not suitable for lamps with an integrated starter

Dimensions (LxWxH): 210x31.4x21.5 mm

Fixing hole distance: 205.5 mm

Nominal voltage: 230 V ±10%, 50–60 Hz

Ambient temperature t_a : 0 to 50 °C

Unit: 25 pcs.

These VS emergency lighting modules include an automatic self-diagnosis feature that performs a two-minute function test of the device, the lamp and the battery every seven days.

In addition, the operating period is tested every 12 months with subsequent battery reactivation.

Optical status display

- Red LED, flashing intermittently: defective lamp. The status display will be reset approx. one minute after the fault has been rectified.
- White LED, not illuminated: if connected to the power supply, the LED must turn green after a maximum of five minutes. If not, the device either has no voltage supply or the emergency lighting module is defective.
- Red LED, permanently flashing: battery capacity is too low or the battery supply line has been interrupted.
- Green LED: fully functional.



Emergency lighting module

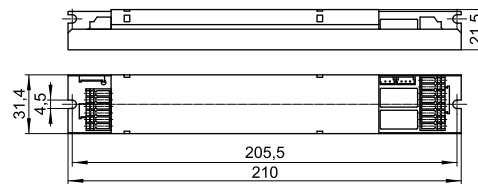

LED

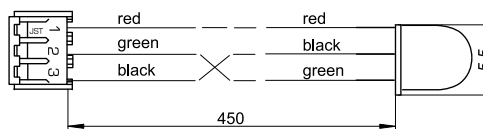

Rechargeable battery

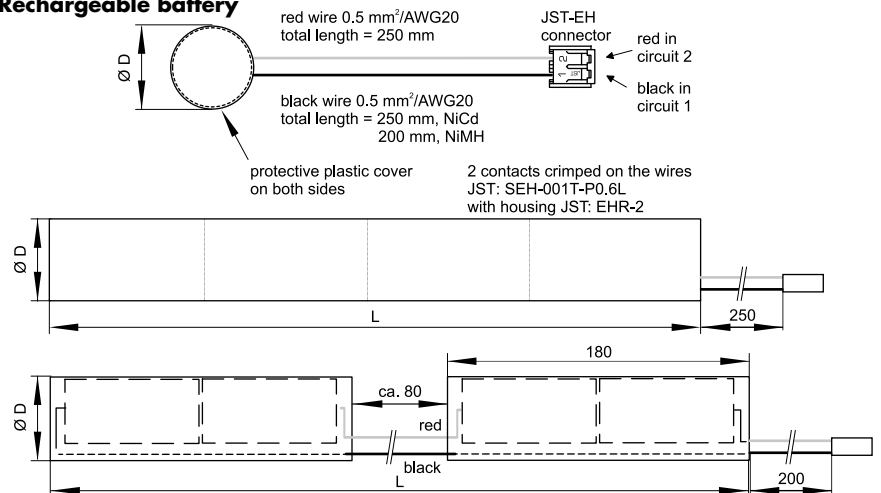

Emergency Lighting Modules 6 to 80 W with Self-Diagnosis Function

EMXs – Emergency lighting modules

Type	Ref. No. Module	Ref. No. Battery	Nominal operating period hrs.	Rechargeable battery type	Dimensions LxD (Ø) of battery mm	Test function	Weight module g	Weight battery g
EMXs 180.000	188792	188823	1	4.8V 1.8Ah NiCd	1 / 190 x 23	automatic	160	200
EMXs 180.001	188793	188824	3	4.8V 4.5Ah NiCd	1 / 240 x 33	automatic	160	490
EMXs 180.002	188794	188825	1	4.8V 1.8Ah NiMH	1 / 200 x 17	automatic	160	140
EMXs 180.003	188795	188826	3	4.8V 4.5Ah NiMH	2 / 450 x 19	automatic	160	320

Circuit diagrams see page 224–226

HOLDERS for Rechargeable Batteries for Emergency Lighting Modules

Material: PC (188828: PBT)

Type: Rechargeable Battery Holder

Ref. No.	For rechargeable battery type	Dimensions (mm)					
		a	b	c	d	e	f
188827	4.8V 1.8Ah NiCd	35.0	18.0	26.3	26.7	13.0	5.5
188828	4.8V 4.5Ah NiCd	39.0	23.2	36.2	37.3	12.4	6.0
188829	4.8V 1.8Ah NiMH	22.5	15.0	22.8	22.5	8.0	4.0
188829	4.8V 4.5Ah NiMH	22.5	15.0	22.8	22.5	8.0	4.0

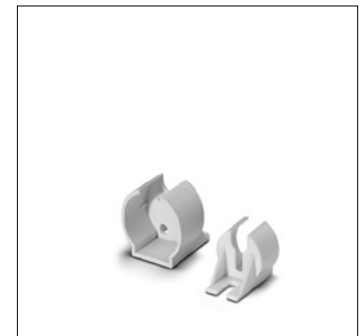
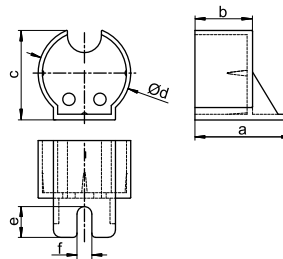

It is recommended to use two holders per rechargeable battery to ensure optimum hold.

Table of suitable lamp types

Lamp type	Lamp nominal output W
T8	15, 18, 32, 36, 58, 70
T5 HE	14, 21, 28, 35
T5 HO	24, 39, 49, 54, 80
T5	6, 8, 13
TR5 (TR16)	22, 40, 55, 60
TR (T29-R)	22, 32, 40
TC-L/TC-F	18, 24, 36, 40, 55, 80
TC-DEL	10, 13, 18, 26
TC-TEL	13, 18, 26, 32, 42, 57, 70
TC-SEL	7, 9, 11
TC-DD (2D)	10, 16, 21, 28, 38, 55

Luminous flux factor of lamps during emergency operation

Lamp nominal output W	Luminous flux factor* %
6	43.0
8	32.0
18	13.0
28	9.0
32	7.0
35	7.0
36	7.0
49	4.7
54	4.3
55	4.7
58	5.2
70	4.3
80	3.7

* Theoretically defined reference values at 25 °C ambient temperature

6

Emergency Lighting Modules for TC and T Lamps

Assembly instructions for emergency lighting modules

221-226

Electrical installation

221

Emergency lighting module display

223

Circuit diagrams

224-226

General technical details

228-236

Glossary

237-239

Emergency lighting modules are designed for operation with 6 to 80 W, 4-pin fluorescent lamps. Luminaires with integrated emergency lighting modules can be operated using a continuous or standby circuit.

Technical specifications	EMXs emergency lighting modules
Permissible mains voltage	230 V ±10%
Permissible mains frequency	50–60 Hz
Power consumption with standby circuit	3 W
Nominal period of operation	1 to 3 hours, depending on the type of rechargeable battery
Batteries	NiCd or NiMH
Ambient temperature	0* to 50°C
Charging time	24 hrs.
Protection class	1
Degree of protection	IP20
Certification	CENELEC
Tested in accordance with	EN 61347-2-7
Suitable for systems compliant with	VDE 0108 / EN 50172
Casing	Metal (zinc-plated)
Installation outside the luminaire	Permissible lead length between the emergency lighting module and the lamp must not exceed two metres.
Luminous flux factors during emergency operation	See the table on page 219, values apply to 25 °C ambient temperature.

* Ignition in progress; the values of the colour rendering index and the luminous flux factor may deviate.

Assembly Instructions for Emergency Lighting Modules

For mounting and installing of emergency lighting modules

If the emergency lighting module is integrated in the luminaire, the LED and battery have to be wired separately, i.e. not in parallel with the mains or lamp. Emergency lighting modules must be fixed in a suitable spot within the luminaire (4-mm bore holes for mounting).

In the interest of maximising battery capacity and service life, care must be taken to ensure the battery is positioned at the coolest part of the luminaire. The ambient temperature of the battery must not exceed 50 °C. Emergency lighting modules must not be mounted on surfaces that ignite, melt or undergo some other thermal change at a temperature of 60 °C. Moreover, emergency lighting modules must not be operated in explosionendangered enclosed spaces.

Electrical installation

The respective ordinances and standards valid at the place of operation must be observed for installation purposes. Emergency lighting modules and luminaires must only be installed by trained staff. Operating voltages exceed 50 V. Caution: potentially fatal hazard!

Prior to first operation of emergency luminaires, all covers must be attached. Furthermore, care must be taken to ensure that the supply voltage complies with the specifications on the type plate and the protective conductor is connected.

1. Fuse
2. Light switch
3. Room lighting
4. Emergency luminaires

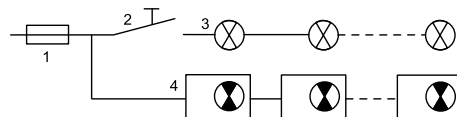

Emergency luminaires must be connected to a direct phase to enable mains monitoring and ensure constant charge retention. This phase must be connected to the group fuse of the regular room luminaire. Emergency luminaires are generally delivered with uncharged batteries and must be connected to the mains for at least 48 hours to be fully functional or for approx. 10 minutes for mains operation in the case of a continuous circuit.

Additional information for optimising EMC

Information on the installation of electronic ballasts for optimising EMC

To ensure good radio interference suppression and the greatest possible operating safety, the following points should be observed when installing electronic ballasts:

- Conductors between the EB and the lamp (HF conductors) must be kept short (reduction of electromagnetic interference). High-potential lamp conductors must be kept as short as possible, in particular with tubular lamps.
Lamp conductors of this kind are labelled with an * in the wiring diagram on the type plate.
- Mains and lamp conductors must be kept separate and if possible should not be laid in parallel to one another. The distance between HF and mains conductors should be as large as possible, ideally > 5 cm.
(This prevents the induction of interference between the mains and lamp conductors.)
- The mains conductor within the luminaire must be kept short (to reduce the induction of interference).
- Devices must be properly earthed. EBs require secure contacts to the luminaire casing or must be earthed using a PE connection. This PE connection should be effected using an independent conductor to achieve better dissipation of the leak current. EMC improves at frequencies greater than 30 MHz.
- The mains conductor must not be laid too close to the EB or the lamp (this is especially important in the event of through-wiring).
- Mains and lamp conductors must not be crossed. Should this be impossible to avoid, conductors should be crossed at right angles to one another to avoid inducing interference between mains and HF conductors.
- Should conductors be wired through metal parts, such conductors must always be additionally shielded (e.g. with an insulating sleeve or grommet).

Maintenance With regard to system maintenance and control, care must be taken to ensure compliance with any ordinances and standards governing emergency lighting at the place of installation. Prior to opening lamp covers, the following procedure must be observed:

1. Disconnect luminaires from the mains voltage.
2. Remove cover.
3. Disconnect battery from the emergency lighting module (disconnect the plug).

VS recommends connecting control LEDs to be visible on the outside of emergency luminaires to enable simple and regular control of emergency luminaires and emergency lighting modules.

Changing batteries

Batteries need to be replaced if the operating period of luminaires falls short of 60 minutes in the case of 1-hour operation and 180 minutes for 3-hour operation, respectively.

Emergency lighting modules have a status display for this purpose.

Spent batteries must be replaced with the manufacturer's original batteries only. Furthermore, the polarity of the batteries must be strictly observed. The battery supply lines of the emergency lighting module are marked as follows:

red = +; black = -

Emergency lighting module display

Normal operation is indicated by a green LED. During emergency operation or for as long as the battery remains fully discharged, the LED is off (i.e. does not glow). The LED will flash red if the battery is missing or not properly connected.

Automatic test of emergency lighting modules

In the case of emergency luminaires with emergency lighting modules, the operational readiness of the device, the lamp and the battery is tested automatically every seven days. In addition, battery capacity is measured during a simulated loss of mains power every 12 months.

The first capacity test will be carried out seven days following initial installation or any repair work. The LED must be checked after the first self-test. A green LED indicates all is in working order, any other display indicates a problem.

The device features a two-colour LED display to indicate that the emergency luminaire is ready for use.

Optical status display

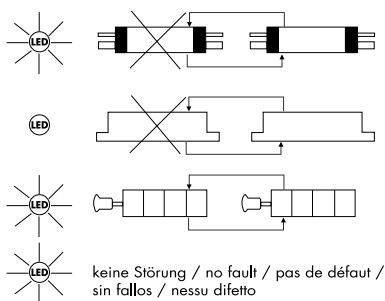

Emergency luminaires merely require regular visual inspection of the status display (LED) and the luminaire itself.

Red LED, flashing intermittently	During initial operation, a lamp recognition test is first carried out. Prior to and during this test, the LED will be red and flash intermittently.
White LED, not illuminated	If connected to mains power, the LED must turn green after a maximum of five minutes. If not, the device has no mains voltage or the emergency lighting module is defective.
Red LED, continuous flashing	Battery capacity is too low or the battery supply line has been interrupted. The warning light will go off again as soon as the problem has been rectified.
Green LED	Fully functional.

Notes

Vossloh-Schwabe accepts no liability for any direct, indirect or incidental damage caused by putting a device to any improper use, i.e. any use not expressly permitted by VS. Similarly, Vossloh-Schwabe accepts no liability for third-party claims arising from putting a device to any improper use, i.e. any use not expressly permitted by VS. Emergency lighting modules must not be opened or modified in any way. The components of emergency lighting modules must be replaced with original parts only.

Should emergency lighting modules be damaged in a way that suggests it cannot be operated safely, the luminaires or emergency lighting modules, respectively, must not be operated. VS reserves the right to make changes to diagrams, weights, tables of dimensions or other such details included in the catalogue or instructions for use without prior notice if such changes prove to be necessary or are made as a result of technological progress. VS emergency lighting modules are patent protected.

Any act of producing counterfeit VS products will be prosecuted according to criminal and civil law.

Caution!

Emergency lighting modules from VS must not be operated with amalgam lamps.

1

2

3

4

5

6

7

8

9

10

Circuit Diagrams

For VS emergency lighting modules

Notes for wiring:

- The distance between mains lead and lead 8 should be as large as possible
- Leads 2/4/6/8 must be kept short

Circuit diagrams – 1-lamp operation

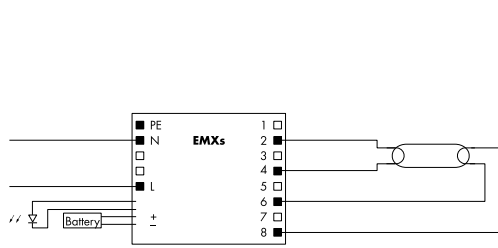

1-lamp operation
without electronic or electromagnetic
ballast (continuous circuits)

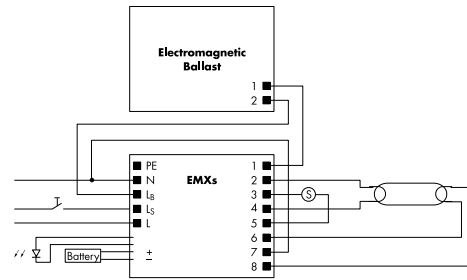

1-lamp operation
with electromagnetic ballast

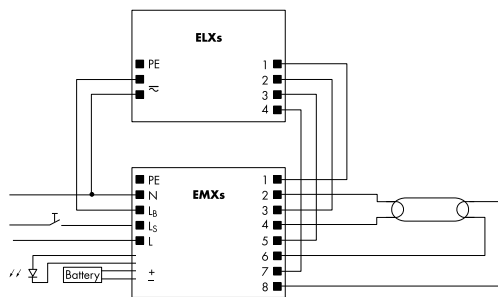

1-lamp operation – Warm start
with electronic ballast ELXs

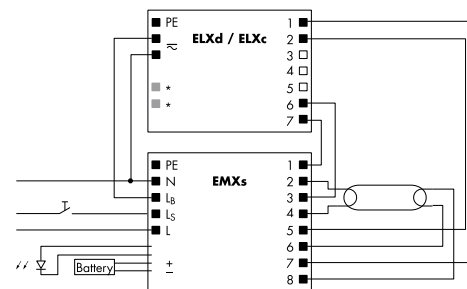

*nur bei dimmbaren Vorschaltgeräten/only with dimmable ballasts/juste avec ballasts
graduables/solo con dimmeratori dimmerabili/solo con reattanza regolabile

1-lamp operation – Dimming / Warm start
with electronic ballast ELXd / ELXc

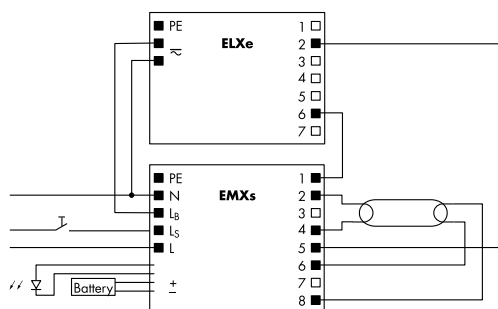

1-lamp operation – Instant start
with electronic ballast ELXe

Circuit diagrams – 2-lamp operation

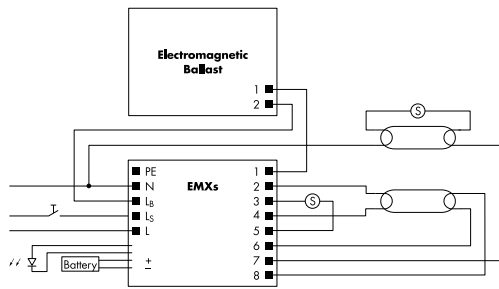

2-lamp operation with electromagnetic ballast

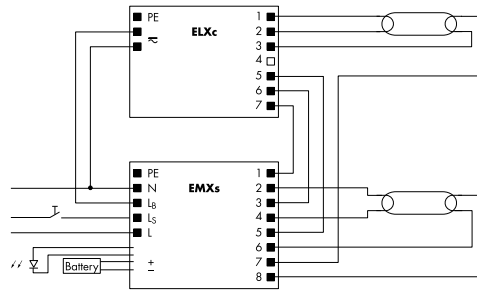

2-lamp operation – Warm start with electronic ballast ELXc

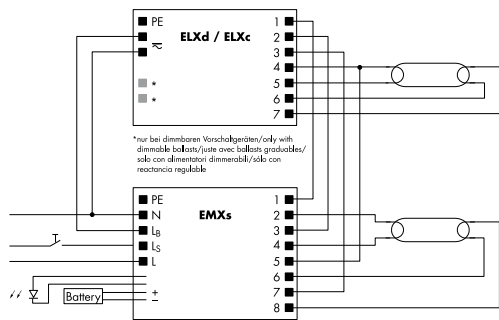

2-lamp operation – Dimming / Warm start with electronic ballast ELXd / ELXc

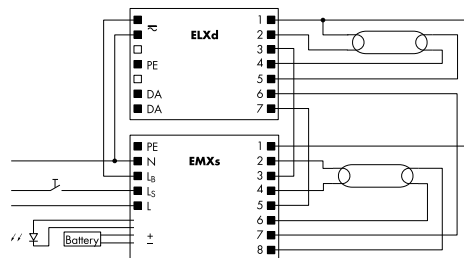

2-lamp operation – Dimming with electronic ballast ELXd

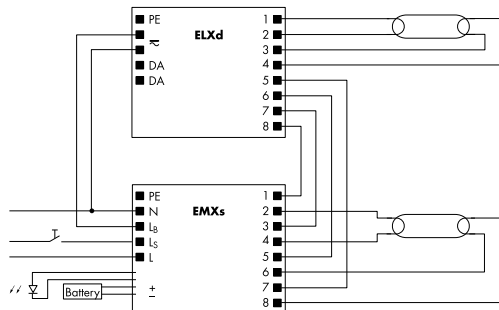

2-lamp operation – Dimming with electronic ballast ELXd

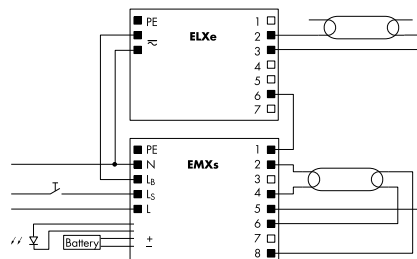

2-lamp operation – Instant start with electronic ballast ELXe

Circuit diagrams – 3-lamp operation

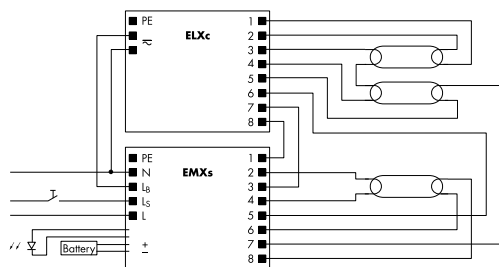

3-lamp operation – Warm start with electronic ballast ELXc

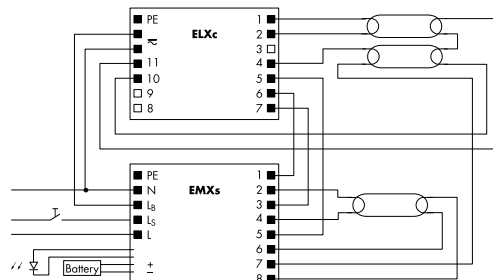

3-lamp operation – Warm start with electronic ballast ELXc

1

2

3

4

5

6

7

8

9

10

Circuit diagrams – 3-lamp operation

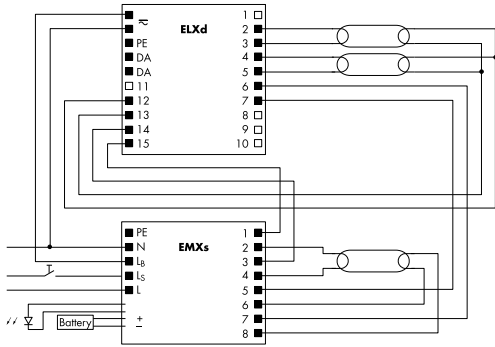

3-lamp operation – Dimming with electronic ballast ELXd

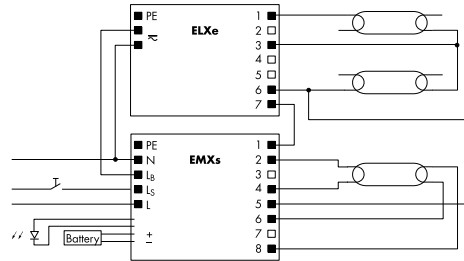

3-lamp operation – Instant start with electronic ballast ELXe

Circuit diagrams – 4-lamp operation

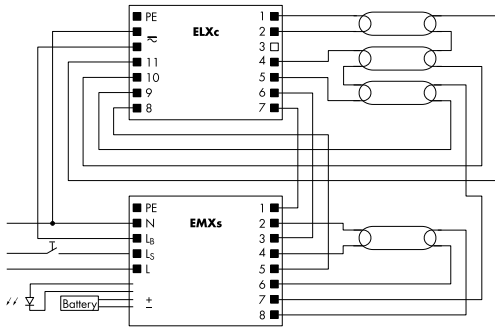

4-lamp operation – Warm start with electronic ballast ELXc

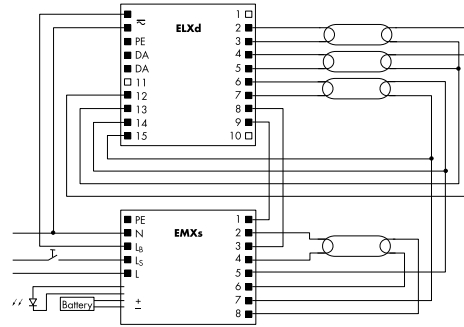

4-lamp operation – Dimming with electronic ballast ELXd

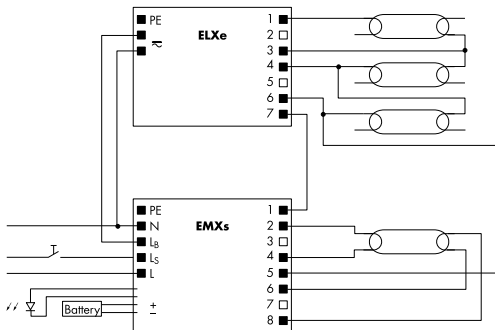

4-lamp operation – Instant start with electronic ballast ELXe

1

2

3

4

5

6

7

8

9

10

7

General Technical Details

General technical details	229–236
Product development and product certification	229–230
CE mark	230
Climate and environmental protection	232
Protection classes of luminaires and operating devices	233
Operating devices with double or reinforced insulation for installation in protection class II luminaires	233–234
Protection classes of luminaires and operating devices	235
Selection of components, materials and dimensions	236
Impulse voltage categories for lampholders	236
Torque to be applied to screws	236
Glossary	237–239

Product development and product certification

The increasingly converging world and the global markets that are being created are both placing new design demands on the sector and its technologies. Against this background, standardisation – both on a regional and international scale – is becoming more and more important in positioning new technologies and innovations on the market. Standardisation ensures the necessary degree of safety, reliability, exchangeability and cost-effectiveness.

Vossloh-Schwabe products have been developed and produced on the basis of technical innovations, internationally and regionally applicable standards and valid environmental regulations for more than 90 years. In this respect, we already take account of integrated components and materials, production methods and technologies, comprehensive environmental aspects as well as a product's energy efficiency during the development phase. An important entrepreneurial goal in all these years has been and continues to be to create lighting components that satisfy the requirements of our customers with regard to safety, function, longevity and cost-effectiveness.

In addition to observing valid, state-of-the-art standards, we also take consideration of the recommendations of industrial associations when developing new products.

Our cooperation in national and international committees ensures we receive early information about new or changed regulations and thus helps to guarantee future-orientated products.

In addition to undergoing internal production approval tests, mass-produced devices are also submitted to national and international testing institutes for certification. The applicable testing and assessment regulations of the testing institutes are subject to international variation. The marks of conformity shown here are therefore not valid for all the products featured in the catalogue. You will find an overview of the approval marks for the products presented in the catalogue from page 240 on. On request, we will gladly provide information about all of the existing approvals.

As the international IEC (International Electrotechnical Commission) standards for lighting technology are also adopted by the European Institute for Standardisation CENELEC (Comité Européen de Normalisation Electrotechnique), the European standards (EN) therefore contain the same requirements. In rare cases, national deviations are permitted. The certification (third-party testing) of VS catalogue products in accordance with EN standards is documented by the ENEC mark.

The ENEC mark (European Norms of Electrical Certification) was created in Europe as a uniform certification mark for electrotechnical products. The ENEC Agreement currently governs the following product groups:

- luminaires
- luminaire components
- energy-saving lamps
- IT equipment
- connection terminals, clips
- capacitors
- couplers
- switches for household appliances
- noise filters
- safety transformers
- tools
- consumer electronic
- batteries
- domestic appliance mobile tools
- IT products

There are plans to include further electrical equipment in the ENEC Agreement.

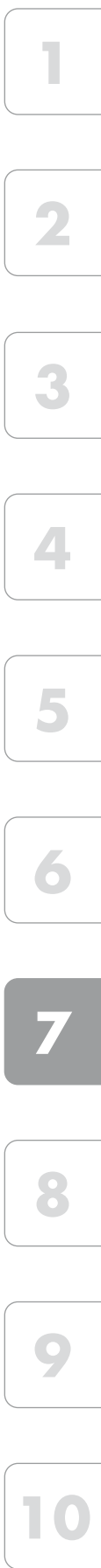

General Technical Details

The certification of products is also expanded to include non-European manufacturers. However, certification testing for lighting equipment must be carried out by an ENEC testing institute in Europe.

At present, a total of 25 testing houses in 22 countries are signatories of the ENEC agreement (see table). Obtaining an ENEC mark for luminaire components like ballasts and ignitors also includes having the product assessed in accordance with the standards governing safety and function. Certification must be based on the EN standards listed in the Agreement. The mark documents that the product not only complies with the applicable standards, but also that ongoing production is monitored by inspectors from a testing institute and that the manufacturer operates an effective quality assurance system in accordance with the ISO 9000 standard suite (International Standards Organisation). ISO deals with the standardisation of non-electrotechnical products.

The ENEC mark is displayed with the identification number and often the logo of the testing institute, as follows:

Identification No.	Testing Institute	Identification No.	Testing Institute
01	AENOR – Spain	16	SGS Fimko – Finland
02	SGS – Belgium	17	NEMKO – Norway
03	IMQ – Italy	18	TRI MEEI – Hungary
04	CERTIF – Portugal	19	ITCL – United Kingdom
05	DEKRA – Netherlands	21	EZÚ – Czech Republic
08	LCIE – France	22	SIQ – Slovenia
09	MIR-TEC – Greece	23	TSE – Turkey
10	VDE – Germany	24	TRLPTÜV – Germany
11	ÖVE – Austria	25	TÜV SÜD PS – Germany
12	BSI – United Kingdom	28	SEP – BBJ – Poland
13	Electrosuisse – Switzerland	30	PREDOM – OBR – Poland
14	Intertek SEMKO – Sweden		EVPU – Slovakia
15	UL Int'l DEMKO – Denmark		

Apart from a product's safety and performance certification, a further useful selection aid is to have a product's electromagnetic compatibility (EMC) tested by an independent test institute, particularly in the case of electronic ballasts. If the product passes the EMC test, an additional test mark is awarded, for instance the VDE EMC mark of the VDE test and certification institute in Offenbach. The EMC certifications for control gears are helpful for the EMC luminaire certification and could reduce time and cost for the luminaire certification.

CE mark

EC Directives form the basis for a common European domestic market without any trade restrictions. Any products that are destined for the European market have to meet the requirements of all directives that apply to the product in question. Compliance with the directives is documented by the CE mark on the product or in the technical documents.



This CE mark is therefore not a mark of compliance with standards (test certificate) of a testing institute, like the ENEC mark is, and can therefore not be issued by a testing institute. The CE mark must be printed on the product, the packaging or both and is not directed at the consumer, but at supervisory authorities.

The following table contains a list of key EC Directives governing lighting:

2019/2020/EC	Regulation setting ecodesign requirements for light sources and separate operating gears pursuant to Directive 2009/125/EC of the European Parliament and of the Council and repealing Commission Regulations (EC) No 244/2009, (EC) No 245/2009 and (EU) No 1194/2012
2019/2015/EC	Delegated Regulation supplementing Regulation (EU) 2017/1369 of the European Parliament and of the Council with regard to energy labelling of light sources and repealing Commission Delegated Regulation (EC) No 874/2012
2017/1369/EC	Regulation establishing a framework for energy labelling and repealing Directive 2010/30/EC
2015/1428/EC	Directive dated 25 August 2015 that amends Directive (EC) No. 244/2009 of the Commission with regard to laying down requirements for the eco-friendly design of households lamps with unbundled light and Directive (EC) No. 245/2009 of the Commission with regard to laying down requirements for the eco-friendly design of fluorescent lamps without a built-in ballast, high-pressure discharge lamps as well as ballasts and luminaires for their operation and for annulling Directive 2000/55/EC of the European Parliament and the Committee and Directive (EU) No. 1194/2012 of the Commission with regard to the eco-friendly design of lamps with bundled light, LED lamps and associated devices.
2015/863/EC	Commission Delegated Directive (EU) 2015/863 of 31 March 2015 amending Annex II to Directive 2011/65/EU of the European Parliament and of the Council as regards the list of restricted substances
2014/53/EC	Requirements for radio equipment (luminaires with built-in transmitters) dated 16 April 2014 governing the harmonisation of legal regulations on retailing radio equipment on the market and to render Directive 1999/5/EC invalid.
2014/35/EC	Electrical equipment designed for use within certain voltage limits (Low Voltage Directive); valid from 20.04.2016
2014/30/EC	Directive on the harmonisation of the laws of the Member States relating to electromagnetic compatibility; national laws had to take effect by 20.01.2007. Applicable to new products since 20.07.2007. (EMC Directive); valid from 20.04.2016
2012/19/EC	Directive governing the recycling of used electric and electronic devices (WEEE Directive)
2012/27/EC	Energy efficiency directive that amends Directives 2009/125/EC as well as 2010/30/EU and renders Directives 2004/8/EC and 2006/32/EC invalid
874/2012/EC	Energy labelling of electrical lamps and luminaires
2011/65/EC	Restrictions governing the use of certain hazardous substances in electrical and electronic devices. On 3 January 2015, the 2011/65/EU (RoHS 2) Directive superseded the previous 2002/95/EC (RoHS 1) Directive. Both directives are unofficially shortened to RoHS (Restriction of Hazardous Substances).
347/2010/EC	Ecodesign requirements for fluorescent lamps without an integrated ballast, for high intensity discharge lamps, and for ballasts and luminaires able to operate such lamps
2010/31/EC	Directive governing the total energy efficiency of buildings
859/2009/EC	Ecodesign requirements on ultraviolet radiation of non-directional household lamps
2009/125/EC	Setting of ecodesign requirements for energy-related products (ErP). This directive supersedes directive 2005/32/EC. The new directive was extended and now includes all energy-consuming products.
1907/2006/EC	Specifications governing the registration, evaluation, authorisation and description of chemicals: REACH (R egistration, E valuation, A uthorisation and R estriction of C hemical Substances) plus amending regulations; e.g. 348/2013/EC, latest amendment of the REACH regulation
2006/95/EC	Electrical equipment designed for use within certain voltage limits (Low Voltage Directive); valid till 19.04.2016
2006/32/EC	Energy end-use efficiency and energy services – ES Directive (Energy Service); national laws must take effect by 17.05.2008.
2006/25/EC	Directive on the minimum health and safety requirements regarding the exposure of workers arising from physical agents (artificial optical radiation)
2005/32/EC	Eco-design requirements for energy-using products – EuP directive (Energy using Products).
2005/20/EC	Directive regarding packaging
2004/108/EC	Directive on the approximation of the laws of the Member States relating to electromagnetic compatibility; national laws had to take effect by 20.01.2007. Applicable to new products since 20.07.2007. (EMC Directive); valid till 19.04.2016
2004/40/EC	Directive on the minimum health and safety requirements regarding the exposure to the risks arising from physical agents (electromagnetic fields)
2004/12/EC	Directive on packaging
2003/66/EC	Directive on energy labelling of household electrical refrigerators, freezers and lamps
2002/96/EC	Old electrical and electronic devices; effective since 13.08.2005; does not fall under the CE mark directive
2002/91/EC	Total energy efficiency of buildings; effective since 04.01.2006; does not fall under the CE mark directive
2001/95/EC	Directive on general product safety
1999/05/EC	Requirements for radio-controlled systems and telecommunications equipment as well as reciprocal acknowledgement of their conformity (R&TTE = Radio Equipment and Telecommunications Terminal Equipment) dated 9 March 1999. Also applies to luminaires with built-in transmitters.
1998/11/EC	Energy rating of household lamps; effective since 14.06.1999
1994/62/EC	Directive on packaging
93/68/EWC	CE marking directive

1

2

3

4

5

6

7

8

9

10

Manufacturers are obliged to keep conformity declarations as well as test and production documentation ready for presentation.

The documents must be retained for a period of 10 years after the product was last marketed.

Vossloh-Schwabe operating devices all bear the CE mark; the respective conformity declaration and production documentation are available for inspection. As a consequence, all luminaires that are equipped with properly installed VS components and for which the assembly instructions were observed meet the legal requirements.

Climate and environmental protection

The European Union adopted a number of EU Directives that are designed to reduce the CO₂ output. Essentially, these objectives can be grouped into three categories:

- requirements placed on new products,
- requirements placed on buildings and
- revision of existing installations.

The requirements placed on new products are governed by the **ErP framework directive** (**E**nergy-related **P**roducts) together with the so-called implementation directives, which envisage the setting of special energy requirements for lamps (minimum lm/W requirements), operating devices (minimum efficiency ratings) and luminaires (minimum energy efficiency requirements) for all lighting technologies.

The directive on energy efficiency requirements regarding ballasts for fluorescent lamps is integrated into the implementation directives.

The requirements for buildings (**EPBD: E**nergy **P**erformance of **B**uildings) specify targets for the maximum permissible primary output of lighting. In so doing, a calculation method is employed that will stipulate the permissible maximum electrical output values of the lighting system using a reference procedure.

With regard to the revision of existing installations the EU member states are called upon to set up national action plans (**Energy Service Directive**) that show which measures can be used to achieve the targeted CO₂ reductions.

In addition to the climate protection requirements, a number of directives were also produced to cover waste reduction and recycling, specifically the **WEEE** (**W**aste of **E**lectrical and **E**lectronic **E**quipment) and **RoHS** (**R**estriction of the use of certain **H**azardous **S**ubstances) directives. These directives regulate the disposal and reduction of waste and the use of hazardous substances.

As a result of the REACH system (**R**egistration, **E**valuation, **A**uthorisation and Restriction of **C**hemical Substances) only registered chemical substances can now be brought onto the market. The principle is: no data, no market.

As operating devices and lampholders are constituent parts of luminaires, these components are to be disposed of along with the luminaire; separate disposal is not provided for.

Protection classes of luminaires and operating devices

The electric shock protection that luminaires and control gears are fitted with provides dual protection, which prevents any danger in the event of a technical defect. With regard to safety, the simultaneous occurrence of two errors can be taken into account in certain circumstances, e.g. given a street luminaire with two lamp casings, one of which is used to house the ballast that operates the lamp. This also applies to low-voltage LED lighting systems.

Luminaires and operating devices of **protection class I** provide protection against electrical shock solely using the base insulation and the safe connection of all exposed conductive parts to an earth conductor. Thus, should the base insulation fail, no exposed conductive parts can become live.

Luminaires and operating devices of **protection class II** provide protection against electrical shock using both the base insulation and an additional or reinforced insulation. Protection class II products do not feature a connection to a protective earth conductor. The mounting conditions do not ensure any additional degree of protection, either.

In special cases with Protection Class II luminaires, it can be permissible to connect a protective conductor or a function protection conductor, as follows:

- **for EMC reasons** – in such cases, it can be necessary to connect a function protection conductor to remain within EMC limiting values. The component manufacturer's specifications regarding the individual operating devices must be observed during the construction of the luminaire. If an operating device is marked as containing a function protection conductor, the creepage and air clearance distances of the operating device connection must comply with the requirements of protection class II (reinforced or additional insulation);
- **as an ignition aid for lamps** – connecting a function protection conductor can be necessary as a capacitive ignition aid for lamps. In such cases the creepage and air clearance distances around the ignition aid within the luminaire and the function protection conductor connection terminal have to comply with the requirements of protection class II (reinforced or additional insulation). The ignition behaviour of a lamp should be agreed with the manufacturer in these cases;
- **when wiring the protective conductor** from the luminaire to another device. This is an installation point of the protective conductor and creepage and air clearances must comply with the respective requirements laid down in the luminaire standard as well as any requirements regarding reinforced or additional insulation.
Functional earth connections of control gear or Protection Class II luminaires must always feature double or reinforced insulation since no technical safety requirements exist for functional earth.

Operating devices with double or reinforced insulation for installation in protection class II luminaires

Protection class II specifications have to be met by the luminaire along with its installed operating device. Both protection class I and class II ballasts can be installed. The design of the luminaire must be adapted to suit. This means that if a protection class I ballast is installed in a protection class II luminaire, the design of the luminaire has to be correspondingly sophisticated to ensure the creepage and air clearance distances can be met. On the other hand, using a protection class II ballast, only available as an independent ballast nowadays, will in most cases result in a need for too much technical effort and thus in high costs. Against this background, the standards contain special requirements for ballasts destined for installation in protection class II luminaires.

These "**double or reinforced insulation ballasts**" and respective protection class II lampholders permit technically and cost-effective construction of protection class II luminaires.



Connection terminal for the protective earth conductor
Protection class I



Connection of the function protection conductor
(will drop in future)



General symbol for an earth connection



Protection class II



Ballasts with double or reinforced insulation



Protection class III

1

2

3

4

5

6

7

8

9

10

Protection class III luminaires provide protection against electrical shock by using Safety Extra Low Voltage (SELV). Luminaires of protection class III are not permitted to generate higher voltages than the Safety Extra Low Voltage (SELV).

The following table, which has been taken from the luminaire standard EN 60598-1, provides an overview of the insulation coordination between the various types of built-in electronic ballasts and the types of insulation found in luminaires.

Operating gear		Necessary insulation between active parts and exposed conductive parts		
Insulation between LV supply and the secondary circuit	Output voltage	Protection class I Insulation of exposed, earthed and conductive parts	Protection class II Insulation of an exposed, conductive part or more as one with potential equalisation	Protection class II Insulation of more than one exposed, conductive part without potential equalisation
None	$U_{OUT} > LV_{Supply}$	Basic insulation suitable for U_{OUT}	Double or reinforced insulation suitable for U_{OUT}	Double or reinforced insulation suitable for U_{OUT}
	$U_{OUT} \leq LV_{Supply}$	Basic insulation suitable for U_{OUT}	Double or reinforced insulation suitable for U_{OUT}	Double or reinforced insulation suitable for LV_{Supply}
Basic	Voltage > ELV	Basic insulation suitable for U_{OUT}	Additional insulation suitable for U_{OUT} plus LV_{Supply}	Insulation must satisfy the higher requirement of a) or b) a) Additional insulation suitable for U_{OUT} plus LV_{Supply} b) Double or reinforced insulation suitable for U_{OUT}
	ELV (FELV)	Basic insulation suitable for U_{OUT}	Additional insulation suitable for U_{OUT} plus LV_{Supply}	Additional insulation suitable for U_{OUT} plus LV_{Supply}
Double or reinforced	Voltage > ELV	Basic insulation suitable for U_{OUT}	Basic insulation suitable for U_{OUT}	Double or reinforced insulation suitable for U_{OUT}
	ELV (SELV)	Basic insulation suitable for U_{OUT}	Basic insulation suitable for U_{OUT}	Basic insulation suitable for U_{OUT}
also see requirement of IEC 60598-1, sections 8, 10 and 11				

Protection classes of luminaires and operating devices

IEC 60529 (EN 60529) defines protection classes for enclosures of casings. The IP Code (International Protection Code) describes the level of protection provided against accidental contact and penetration by foreign bodies as well as protection against water. The first number stands for protection against foreign bodies, the second stands for protection against water. These specifications are important with particular regard to built-in or mounted luminaires as the provisions governing protection against accidental contact provide the basis for the insulation system for components and conductors (also see luminaire standard EN 60598-1).

To comply with the IP requirements, the installation instructions supplied by the luminaire and/or operating device manufacturer(s) must be observed.

Number	1st Number		2nd Number
	Protection against contact	Protection against foreign bodies	Protection against water
0	No protection	No protection	No protection
1	Protected against contact with the back of the hand	Protected against solid foreign bodies $\varnothing \geq 50$ mm	Protected against vertically dripping water
2	Protected against finger contact	Protected against solid foreign bodies $\varnothing \geq 12$ mm	Protected against diagonally dripping water (angle of 15° from above)
3	Protected against contact with tools	Protected against solid foreign bodies $\varnothing \geq 2.5$ mm	Protected against diagonal water spray up to an angle of 60° from above
4	Protected against contact with wire	Protected against solid foreign bodies $\varnothing \geq 1$ mm	Protected against water splashes from any direction
5	Protected against contact with wire	Protected against dust	Protected against jets of water
6	Protected against contact with wire	Dust-tight	Protected against strong jets of water
7	–	–	Protected against temporary immersion in water
8	–	–	Protected against permanent submersion in water. Specific testing conditions must be agreed, especially with regard to high-pressure cleaning equipment.
9	–	–	For high-pressure cleaning IPx9 in accordance with DIN 4005

If any components like ballasts or conductors of built-in or mounted luminaires (e.g. wall-mounted luminaires) are accessible to accidental contact, they must comply with the requirements of the two safety levels stipulated for these components. Luminaire construction must be in line with these conditions, which can mean that, for instance, conductors have to feature additional or reinforced insulation.

For lampholders the compliance with the two safety levels is proved by conducting a special voltage test.

European standard EN 50102 "Degrees of protection provided by enclosures for electrical equipment against external mechanical impacts (IK code)" introduces an IK code, analogous to the IP degree of protection of electrical control gear, that was also adopted as a national standard in France, e.g. with the French standard NF EN 50102. Testing is carried out using a pendulum hammer that, in accordance with the IK code, must be dropped from a certain height with respective weights attached to exert the specified impact energy. The table details impact energy values for luminaires (IK00 to IK10).

IK Code	Energy Nm or Joule	IK Code	Energy Nm or Joule
IK00	0.0	IK06	1
IK01	0.14	IK07	2
IK02	0.2	IK08	5
IK03	0.35	IK09	10
IK04	0.5	IK10	20
IK05	0.7		

1

2

3

4

5

6

7

8

9

10

Selection of components, materials and dimensions

The documentation provided by Vossloh-Schwabe is carefully researched. Technical advice is given to the best of our knowledge. The details on the product or the type plate are binding in every case.

Any manipulation of VS products or product packaging is illegal and violates registered trademark rights. Manipulations can negatively influence or destroy technical properties and can possibly result in secondary damage. Vossloh-Schwabe does not accept any liability for manipulated products and cannot be held responsible for any secondary damage.

Manufacturers of luminaires and lighting systems remain responsible for the selection of suitable luminaire components, e.g. operating devices and lampholders, and component materials just as for their safe and correct installation in line with luminaire and system set-up regulations.

Particular attention should be paid to the following:

- temperature measurements and temperature limits
- compliance with creepage and air clearance distances and insulation thicknesses
- selection of components to suit their operating conditions and degree of strain (e.g. voltage, current, mechanical loading, UV radiation)
- protection against contact and safe protective earth conductor connections
- resistance to corrosion

The product drawings without tolerances are contained in this catalogue only feature nominal dimensions. For space and simplicity reasons, the full dimensions and particularly the associated tolerances cannot be shown. For detailed information resp. details of luminaire design, please request our in-depth dimensional assembly drawings.

All VS products comply with the relevant standards and are developed and produced using the latest technological expertise.

To ensure safe luminaire production we do not recommend reusing dismantled lampholders.

Impulse voltage categories for lampholders

Lampholder	Standard	Impulse voltage category
E14: 250 V / 2 A	IEC 60238 / VDE 0616-1	2
E27: 250/500 V / 4 A		2
E40		2
Starters: 250 V / 2 A	IEC 60400 / VDE 0616-3	2
Fluorescent lamps 250 V / 500 V / 2 A	IEC 60400 / VDE 0616-3	2
Halogen lamps and other lamps	IEC 60838-1 / VDE 0616-5	2
Bayonet fitting	IEC 61184 / VDE 0616-2	2

Torques for screws

With regard to lampholders secured with screws, we recommend using a torque of around 80% of the value stipulated in DIN EN 60598-1

Nominal diameter of the screw's outside thread mm	Torque (Nm) for screws with a head in acc. with DIN EN 60598-1
to 2.8	0.40
< 2.8 to 3.0	0.50
< 3.0 to 3.2	0.60
< 3.2 to 3.5	0.80
< 3.6 to 4.1	1.20
< 4.1 to 4.7	1.80
< 4.7 to 5.3	2.00
< 5.3 to 6.0	2.50

A A type, B type capacitors	The requirements of the safety standard for capacitors differentiates between capacitor types; A type capacitors stand for plastic can capacitors; B type capacitors stand for aluminium can capacitors.
Analogue interface 1-10 V	Bipolar interface of dimmable operating devices with a built-in constant current source.
Average service life	Specified service life of electronic operating devices with a failure rate per unit of time.
B Ballast	Device that is connected in between the voltage supply and one or more discharge lamps and serves the purpose of igniting the lamps and limiting lamp current during operation.
Ballast-Lumen Factor (luminous flux factor of a ballast)	The ratio of luminous flux emitted by a reference lamp when operated with a particular production ballast to the luminous flux emitted by the same lamp when operated with its reference ballast.
C Capacitive circuit (series compensation)	Circuit of an inductive ballast with a capacitor connected in series.
CE Mark	European regulation governing all products that are introduced to the market. Products must comply with the respective EC directives.
CELMA	Association of European component and luminaire manufacturers (Committee of E.E.C. Luminaires Components Manufacturers Associations).
CENELEC	European committee for electronic standardisation (Comité Européen de Normalisation Electrotechnique).
CISPR	International special commission for radio interference (Comité International Spécial des Perturbations Radioélectriques).
Colour rendering index (CRI) R_a	Index to determine the degree of deviation from a viewed body colour (with 8 standardised test colours) under a given type of lighting. $R_a = 100$ denotes a light source that causes no distortion of any colour. Lower R_a values denote light sources with less positive colour rendition properties.
Compensated circuit (parallel compensation)	Circuit of an inductive ballast with a capacitor between phase and neutral conductor.
Compensation capacitors	The power factor can be increased to a value of 0.9-0.98 by using compensation capacitors.
Conformity declaration	Documentation for an operating device or a luminaire regarding compliance with European directives; this documentation is for submission to national supervisory authorities (e.g. regulation authority for telecommunications and post (Reg. TP) or trade supervisory authorities).
Convertors	Electronic convertor (electronic conversion of mains voltage in extra-low voltage) to generate operating voltage for low-voltage halogen lamps.
Creepage and air clearance distances	Regulation minimum distances between voltage-carrying components of different polarity or between voltage-carrying components and the accessible casing surfaces (air clearance: shortest distance through air; creepage distance: shortest distance across a surface).
Cross discharge	Discharge in the lamp electrode region during preheating.
D DALI	Digital interface for controlling dimmable electronic operating devices (Digital Addressable Lighting Interface).
Δt	Increase in the winding temperature during the operation of a ballast (the ballast is mounted on 75 mm high wooden blocks and its temperature is measured at an ambient temperature of 25 °C).
Δt_{an}	Temperature increase during short-circuit operation (e.g. defective starter, defective lamp).
DIAL	German institute for applied lighting technology (Deutsches Institut für Angewandte Lichttechnik, Lüdenscheid, Germany).
DiiA	The Digital Illumination Interface Alliance (DiiA) is an open, global consortium of lighting companies. DiiA aims to grow the market for lighting-control solutions based on digital addressable lighting interface (DALI) technology.
DKE	German electrotechnical commission of the DIN and VDE.
Driver	Name commonly given to ballasts used for operating LED modules.
E EC directives	Regulations (laws) of the European Community that have to be transposed into national laws within a prescribed period of time.
Efficiency	Ratio of power output in relation to power input.
ELC	European Lamp Companies Federation
EMC	Electromagnetic compatibility
EMF	Electromagnetic fields
ENEC agreement	Agreement between the European testing institutes for issuing the European test mark.
ENEC mark	Marking for a device that complies with the European standards and that was tested by a testing institute that is a part of the ENEC agreement (European Norms of Electrical Certification).
Energy classification EEI	CELMA system to determine energy classes for ballasts for fluorescent lamps (Energy Efficiency Index).
Error current	Current that is caused by a fault in the insulation of a device or via creepage or air clearance distances.
Error current protection switch	Evaluates the magnitude of the error current and switches the circuit off if a predefined maximum value is reached.
F Feed-through of mains voltage	The possibility of connecting two lamps to a single terminal so that an electrical connection can be made to another device.
FELV	Functional extra-low voltage without adequate protection from accidental contact with higher voltages in other parts of the same circuit.
FEP capacitors	Flame- and explosion-proof capacitors with a contact breaker.
FGL	Promotion Society for Good Lighting (Fördergemeinschaft Gutes Licht – ZVEI).
Function protection conductor	It may be necessary to connect a "function protection conductor" to ensure compliance with the EMC requirements or as a starting aid for lamps; VS operating devices are suitably marked.

1

2

3

4

5

6

7

8

9

10

I IDC terminal (ALF terminal)	IDC-type connection terminal (Insulation Displacement Connection) for automatic luminaire fabrication (ALF terminal).
IEC	International Electrotechnical Commission
ILCOS lamp designation system	International IEC marking system for lamps.
Illuminance Ev	Illuminance (Ev) is the total luminous flux (Φ) incident on a horizontal, vertical or angled illuminated surface (per unit area). The unit is lux [$\text{lx}=\text{lm}/\text{m}^2$], with luminous flux in [lm] and area in [m^2]. Illuminance Ev forms the basis for all lighting calculations and designs.
Impedance	Impedance is a conductor's apparent resistance to an alternating current.
IMQ	Italian institute for quality marking; at the same time, the mark of conformity with standards (Istituto Italiano del Marchio di Qualità).
Independent lamp operation	Possibility of operating a single lamp with a multi-lamp operating device after the other lamps have failed.
Independent operating device	Operating device that does not have to be installed in a casing; the safety regulations are fulfilled by the operating device itself.
Inductance	Inductance establishes the connection between the current and the magnetic flux caused by it in a conductor arrangement after taking account of all design and material fluctuations.
Inductive circuit	Operation of a fluorescent lamp with a ballast without a capacitor.
Interference	Interference signals emitted by operating devices via the mains voltage or the air.
Interference immunity	Property of an operating device to remain fully functional despite interference emitted by other operating devices.
IP numbers	Code system for marking the protection level of an operating device or a luminaire against moisture or foreign bodies entering (the first figure stands for foreign bodies and the second for moisture).
IPP technology	Generating the ignition voltage required for high-pressure lamps using the special intelligent pulse pause technology.
L LBS lamp designation System	Marking system for lamps, established for Europe.
Leak current	Current of an operating device or a luminaire that is discharged via the potential compensation conductor (earth conductor).
LED (light emitting diode)	Solid state device embodying a p-n junction, emitting optical radiation when excited by an electric current.
LED light engine	Functional unit consisting of an LED module and control gear. The LED light module and the control gear can be used separately in two different casings or combined as a single unit.
LED module	Unit supplied as a light source. In addition to one or more LED's it may contain other components, e.g. optical, electrical, mechanical and/or electronic.
Light colour	Perceived colour of the light radiated by a lamp.
LightingEurope	An industry association consisting of European lamp, component and luminaire manufacturers as well as national lighting associations in Europe. LightingEurope is the successor organisation of CEI/MA and ELC (European Lamp Companies). LightingEurope represents the interests of the European lighting industry.
Light intensity distribution curve	Represents the spatial distribution of the light intensity of light sources.
LiTG	German Association for Lighting Technology (Deutsche Lichttechnische Gesellschaft)
Luminance L	Luminance L is the luminous intensity density of an area that emits or reflects light with a certain emission angle. The unit of luminance L is [cd/m^2] and is the photo-technical measure that corresponds to the subjective perception of the level of brightness of a light source or an object, while luminous flux Φ , luminous intensity I and illuminance E are not visible, i.e. not sensed by the human eye. Light only becomes visible when it hits an object that it is either reflected by or penetrates in a diffused manner. Objects of different levels of brightness therefore only seem to be darker or brighter at same illuminance because they reflect the light differently.
Luminous efficiency / efficiency	Ratio of luminous flux to power input (lm/W).
Luminous flux Φ (photon radiation)	Luminous flux Φ is the radiated/emitted light power in lumen [lm] of a light source, a unit of measurement for the number of light photons emitted in all directions. Luminous flux is the photometrical light output perceived by the human eye.
Luminous intensity I	Luminous intensity I in [cd] is decisive for characterising of a source of light and is defined as a quotient of the emitted luminous flux Φ and the radiated area of the solid angle Ω . Luminous intensity I is thus the focused luminous flux Φ within the radiated solid angle Ω . Today's LEDs can reach a luminous intensity of more than $I=10$ cd. The luminous intensity value depends on the viewing angle, i.e. the luminous intensity of an LED chip in a 30° reflector will be higher than that of an identical LED chip in a 60° reflector. This is because a 60° reflector results in the same luminous flux Φ having to illuminate a larger area.
M Mains harmonics	Mains current distortions by higher-frequency currents.
Master/slave circuit	Operating several lamps in different luminaires with one ballast.
μF	Unit of capacitance (microfarad)
MPP capacitors	Metallised polypropylene film dielectric capacitors.
P Parallel-compensated circuits	Circuit of an inductive ballast with a capacitor between phase and neutral conductor (connected in parallel to the lamp circuit).
Part load range	Variable load range up to the maximum rated load.
PELV	Protective extra-low voltage with adequate protection from accidental contact with higher voltages in other parts of the same circuit.
Phase-cutting leading-edge control	In accordance with the defined angle, voltage regions are suppressed of the positive and negative sinusoidal oscillations of the mains voltage in an upwards direction starting with the voltage zero crossing.
Pinch temperature	This is measured at a defined point of the lamp base; the permissible maximum values are internationally determined.
Polyester resin impregnation	High-grade vacuum impregnation with polyester resin.
Power factor	Ratio of true power to apparent power (total power). Lambda (λ) expresses the power factor for non-sinusoidal currents and voltages. In contrast, $\cos \phi$ (ϕ) expresses the power factor for sinusoidal currents or voltages.
Pulse Ignition	Generation of the ignition voltage for high-pressure lamps with the help of ballasts (ballast insulation must match the ignition voltage).
PUSH	Key-operated bipolar interface of VS electronic ballasts for controlling the brightness of connected lamps.

R Reference ballast	Special ballast that is either inductive for lamps operated with mains voltage or ohmic for lamps operated at high frequencies. Reference ballasts are designed to deliver comparable values for testing ballasts, selecting reference lamps and testing mass-produced lamps under standardised conditions.
Reference lamp	When used in combination with a suitable reference ballast, reference lamps provide key electrical data that are close to the target values laid down in the lamp standards.
S Safety transformer	Isolation transformer for supplying circuits with safety extra-low voltages.
SELV	Safety extra-low voltage.
Short-circuit-proof	Short-circuit-proof operating devices do not pose a safety risk if a short-circuit occurs at the output of the operating device; a difference is made between operating devices offering limited and unlimited protection against short-circuit; in the case of operating devices with limited short-circuit protection, an additional mechanism has to be installed.
Solid angle Ω	Solid angle Ω is the area within a sphere that is pervaded by the light emitted by a light source. The steradian (sr) is the unit of measure for solid angle, whereby $1 \text{ sr} = 65.5^\circ$. This describes a cone with its peak in the light source and a beam spread angle of 65.5° . A whole solid angle is expressed as $4\pi \text{ sr} = 12.56 \text{ sr}$.
Standards	VS products comply with the regulations of the following European standards: <ul style="list-style-type: none"> • Electronic ballasts for fluorescent lamps: EN 61347-1, EN 61347-2-3, EN 60929, EN 55015, EN 61547, EN 61000-3-2, IEC 62493 • Electronic ballasts for high-pressure discharge lamps: EN 61347-1, EN 61347-2-12, EN 55015, EN 61547, EN 61000-3-2, IEC 62493 • Electronic converters: EN 61347-1, EN 61347-2-2, EN 61047, EN 55015, EN 61547, EN 61000-3-2, IEC 62493 • Electromagnetic ballasts: EN 61347-1, EN 61347-2-8, EN 61347-2-9, EN 60921, EN 60923, EN 50294, EN 55015, EN 61547, EN 61000-3-2, IEC 62493 • Electromagnetic transformers: EN 61558-1, EN 61558-2-6, EN 55015, EN 61547, EN 61000-3-2, IEC 62493 • Ignitors: EN 61347-1, EN 61347-2, EN 60927, EN 55015, EN 61547, EN 61000-3-2 • Capacitors: EN 61048, EN 61049 • Lampholders: EN 60238, EN 60400, EN 60838-1, EN 61184, EN 60399 • Digital control inputs of operating devices: IEC 62386 • LED: IEC 62031, IEC 61347-1, IEC 61347-2-13, IEC 62384, IEC 61231, IEC TR 61341, IEC 60838-2-2, IEC 62471(-1), IEC 62471-2 • EMC/EMF: EN 55015, EN 61547, EN 61000-3-2, IEC 62493
Stroboscopic effect	Optical illusion whereby objects appear either to be moving or stationary in contrast to their actual state when illuminated by periodically alternating light.
Superimposed ignition	Generation of the ignition voltage required for high-pressure lamps by the ignitor independent of the ballast (superimposed over the mains voltage).
System power consumption	Total power input of lamp and operating device (in watt).
T t_a	Ambient temperature
TALQ	Industrial consortium for the globally recognised standardisation of a management software interface for outdoor lighting networks. The aim is to enable the interoperability of central management systems and outdoor lighting networks made by different manufacturers.
Tandem circuit	Series connection of two fluorescent lamps using a single ballast.
t_c	Maximum operating temperature of the casing at the marked measuring point.
Temperature details	The temperature details on our VS ballasts are always maximum values; these are based on the maximum voltage values given on the type plate.
The Connected Lighting Alliance	Industrial consortium that was founded by GE Lighting, Lutron, OSRAM, Panasonic, Philips, Toshiba in August 2012 for the purpose of supporting global use and distribution of wireless connectivity in lighting applications.
Thermal classes	Classification of transformers according to the degree of heat resistance offered by the insulation materials.
Thermal cut-out	Protection from overheating due to abnormal lamp conditions (rectifier effect, short-circuit and overload), with automatic restart after cooling.
Transient mains overvoltages	Voltage peaks that briefly occur and are superimposed over the mains voltage.
T rating	Rated value of the lampholder's maximum operating temperature (e.g. T130).
Tungsten-halogen cycle	In the outer, cooler part of the lamp, the halogen combines with the tungsten vapour released by the filament to form a tungsten-halogen molecule which then decomposes and deposits the tungsten on the filament.
t_w	Maximum permissible winding temperature.
U UL, UL approval	Underwriters' Laboratories Inc., USA; US conformity mark for safety.
V VDE mark	Safety mark on the basis of the German safety standard for electrical equipment; tested by the VDE-PZI (Verband Deutscher Elektrotechniker – Prüf- und Zertifizierungsinstitut).
W Winding temperature	Temperature of the copper winding in a magnetic ballast; the change in winding temperature is measured using the change of the resistance of the copper winding.
Z Zhaga	Global industrial consortium that has taken on the task of standardising the interfaces needed for LED light engines.
ZVEI	Central association of the electrotechnical and electronics industry in Germany (Zentralverband Elektrotechnik- und Elektronikindustrie e.V.).

1

2

3

4

5

6

7

8





















9

10

Reference Numbers

Ref. No.	Type	Page	Approval
100061	02110	118	1,3
100063	02111	118	1,3
100064	02120	118	1,3
100125	03210	200	—
100194	06700	200	—
100217	07400	201	—
100270	08610	200	—
100273	08701	200	—
100305	09105	104	1,3
100310	09205	104	1,3
100437	20200	122	—
100442	20400	113	—
100448	20501	113	—
100487	22602	109	1,3
100548	27350	109	1,3
100552	27360	109	1,3
100572	27722	112	1,3
100591	28500	108	1,3
100593	28501	108	1,3
100596	28600	108	1,3
100598	28601	108	1,3
100710	30523	172	1,3
100720	30550	172	1,3
100912	32300	170	1
100913	32301	47	1
100921	32311	47	1
100922	32321	47	1
100925	32326	48	1
100928	32330	48	1
100931	32336	49	1
100932	32341	48	1
100934	32361	48	1
100937	32381	48	1
100939	32400	163, 164, 166	1
101162	32600	165	1
101207	32620	165	1
101248	32680	165	1
101253	32690	165	1
101258	32700	163	1
101274	32720	163	1
101298	35004	95	1,3
101306	35006	95	1,3
101310	35007	95	1,3
101320	35010	95	1,3
101324	35011	96	1,3
101344	35051	96	1,3
101346	35052	96	1,3
101485	36050	97	1,3
101489	36051	97	1,3
101491	36052	97	1,3
101493	36053	97	1,3
101627	43000	118	1,3
101643	46100	112	1,3
101647	46101	112	1,3
101674	47100	110	1,3
101681	47102	110	1,3
101685	47105	110	1,3
101690	47106	110	1,3





















Ref. No.	Type	Page	Approval
101706	47200	111	1,3
101712	47205	111	1,3
101716	47206	111	1,3
101738	47500	110	1,3
101740	47502	110	1
101745	47504	111	1,3
101749	47505	110	1,3
101753	47506	110	1,3
101765	47600	111	1,3
101769	47605	111	1,3
101773	47606	111	1,3
101781	47700	111	1,3
101784	47900	111	1,3
101787	48500	112	1,3
101789	48501	112	1,3
101791	48502	112	1,3
101793	48503	112	1,3
102577	62010	43, 193	1
102582	62015	43, 193	1
102599	62050	43, 193	1
102615	62104	43	1
102617	62105	43	1
102624	62310	44, 193	1
102635	62600	42	1
102637	62601	42	1
102938	80003	183	—
102939	80003	183	—
102946	80006	183	—
102947	80006	183	—
102956	80014	196	—
103020	80342	195	—
103021	80342	195	—
103026	80343	195	—
103027	80343	195	—
103087	80433	201	—
103359	81019	182	—
103360	81019	182	—
103365	81022	183	—
103366	81022	183	—
103414	81093	180	—
103415	81093	180	—
103424	81095	180	1,33
103430	81109	180	—
103431	81109	180	—
103442	81120	180	—
103443	81120	180	—
103467	83000	189	—
103468	83000	189	—
103483	83002	190	—
103484	83002	190	—
103504	83006	196	1
103515	83008	196	1
103520	83011	189	1,33
103569	83173	190	—
103570	83173	190	—
103582	83218	195	—
103583	83218	195	—
103587	83218	196	—

- 1  ENEC
1a applied
- 2 
- 3  UL US
- 5 
- 7 
- 13 
- 13a 
- 14  VDE
14a applied
- 15 
- 16 
- 17 
- 19 
- 25 
- 28 
- 31 
- 32 
- 33 
- 34  UL US
- 35 
- 36  DEKRA

Reference Numbers

Ref. No.	Type	Page	Approval
103590	83219	195	—
103591	83219	195	—
103594	83219	196	—
103595	83221	195	1
103597	83223	195	1
103643	83285	189	1,33
103709	84122	115	—
103710	84122	115	—
103711	84123	115	—
103712	84123	115	—
104928	94304	196	—
105144	96010	196	—
105775	35060	98	—
105776	35060	98	—
105777	35760	98	—
105931	35061	98	—
106094	98085	115	—
106256	94060	166	—
106417	35760	98	—
106457	32480	165	1
106585	62110	43	1
106767	94068	201	—
106768	94069	201	—
106817	98006	198	—
106829	94450	202	—
106948	09501	203	—
106949	09502	203	—
107096	83015	197	1
107154	05202	200	—
107192	32360	171	1
107193	32340	171	1
107194	32320	171	1
107195	32310	171	1
107213	32390	170	1
107214	32391	170	1
107215	32395	171	1
107331	83015	197	1
107677	21100	49	34
107694	33100	167	—
107716	81096	180	1,33
107780	12801	45, 204	1
107958	84172	114	1,3
107960	84174	114	1,3
108208	12800	45, 204	1
108267	98004	107, 114	—
108373	12812	45, 204	1
108374	12810	45, 204	1
108375	12811	45, 204	1
108416	62622	42	1
108438	28921	109	1,3
108608	84175	114	1,3
108614	84175	114	1,3
108666	84172	114	1,3
108669	84174	114	1,3
108747	64740	185	1,33
108748	64800	199	1
108758	64741	186	1,33
108816	22604	109	1,3

Ref. No.	Type	Page	Approval
108845	97117	113	—
108878	36060	99	1,3
108898	35012	96	1,3
108936	64401	184	1,33
108953	64770	185	1,33
108965	64501	184	1,33
108979	31000	169	1,3
108983	64307	177	1,33
109007	31010	169	1,3
109039	83007	190	—
109041	81130	181	—
109044	96172	192	—
109045	97511	188	—
109052	83007	190	—
109054	81130	181	—
109060	96172	192	—
109062	97511	188	—
109074	83293	191	—
109077	85070	186	—
109081	83274	191	—
109084	96159	181	—
109086	97147	113	—
109087	83293	191	—
109092	85070	186	—
109093	83274	191	—
109095	96159	181	—
109098	83035	190	—
109099	83035	190	—
109102	81002	181	—
109103	81002	181	—
109110	85075	178	—
109112	85075	178	—
109145	81024	181	—
109149	96211	181	—
109150	96211	181	—
109152	81132	182	—
109153	81132	182	—
109158	83297	198	1
109159	83282	188	—
109162	03210	200	—
109166	05202	200	—
109184	97698	187	—
109187	96148	190	—
109188	96148	190	—
109190	96154	191	—
109191	96154	191	—
109195	96147	191	—
109196	96147	191	—
109198	83260	197	—
109199	83260	197	—
109200	96229	197	—
109201	96229	197	—
109235	35610	94	1,3
109238	35611	94	1,3
109240	35612	94	1,3
109243	83300	198	—
109247	09708	202	—
109248	09701	203	—





















1	
1a	ENEC applied
2	
3	
5	
7	
13	
13a	
14	
14a	VDE applied
15	
16	
17	
19	
25	
28	
31	
32	
33	
34	
35	
36	

- 1
- 2
- 3
- 4
- 5
- 6
- 7
- 8
- 9
- 10

Reference Numbers

Ref. No.	Type	Page	Approval
109249	09703	202	—
109253	09701	203	—
109285	08610	200	—
109291	08701	200	—
109317	96160	203	—
109318	96160	203	—
109330	27700	108	1,3
109331	27701	108	1,3
109383	64001	176	1,33
109384	64001	176	1,33
109386	64101	176	1,33
109387	64101	176	1,33
109411	97244	169	—
109429	64501	184	1,33
109462	83282	188	—
109497	32380	172	1
109512	96124	191	—
109547	33300	162, 164, 166	1,34
109548	97255	162	—
109553	94095	164	—
109554	94096	166	—
109555	97260	188	—
109556	97260	188	—
109559	96124	191	—
109560	97698	187	—
109568	62111	43	1
109592	09705	203	—
109600	09704	203	—
109621	94435	201	—
109674	33400	162	1,34
109676	97636	178	—
109677	97636	178	—
109679	97665	187	—
109680	97665	187	—
109685	94088	106	—
109686	09170	106	1,3
109725	97750	202	—
109728	97752	202	—
109794	97664	187	—
109795	97664	187	—
109805	81024	181	—
140413	Z 70 S	24	1,14
140425	Z 250 S	25	1,14
140427	Z 400 S	26	1,14
140430	Z 1000 S	29	1,14
140432	Z 2000 S	32	—
140471	Z 1000 L	30	—
140481	Z 70 K	24	1,14
140489	Z 250 K	25	1,14
140496	Z 1000 S/400 V	30	14
140497	Z 2000 S/400 V	32	14
140499	Z 3500 S/400 V	32	—
140537	CE 50	38	—
140594	Z 400 M	27	1,14
140597	Z 400 M K	27	1,14
140607	Z 1000 TOP	29	14
140608	Z 1200/2,5	31	—
140609	Z 1200/9	31	—





















Ref. No.	Type	Page	Approval
140613	PZS 1000 K	34	14
140617	PZI 1000/1 K	34	14
140621	PU 12 K	35	14
140622	PU 120 K	35	14
140623	PU 121 K	35	—
140627	AS 1000 K	37	1,14
140693	Z 400 M S	27	1,14
141580	Z 70 K D20	24	1,14
141581	Z 250 K D20	25	1,14
141582	Z 400 M K D20	27	1,14
141583	Z 400 S D20	26	1,14
141584	Z 1000 S D20	29	1,14
142150	PR 12 K D	35	14
142170	PR 12 K LC	35	14
142330	Z 70 K D20	24	1,14
142350	Z 250 K D20	25	1,14
142370	Z 400 M K D20	27	1,14
142736	SPC 230/10 K	9	1,14
142737	SPC 230/10 K/i	13	13,36
142738	SPC 3/230/10 K/i	13	13,36
142742	SPC 3/230/10 K/i	13	13,36
142743	SP3/230/10 K/i	11	13,36
142744	SP3/230/10 K/i	11	13,36
142746	SPC 3/230/10 K/iHP66	13	—
142747	SPC 3/230/10 K/iHP66	13	—
142748	SPC 3/230/10 K/iHP66	13	13,36
142751	SPC3/230/20 K/i	11	—
142752	SPC3/230/20 K/i	11	—
142753	SPC3/230/10K/i DALI	12	—
142754	SPC3/230/10K/i DALI DI	12	—
142755	SPC3/230/10K/i LS	12	—
142756	SPC3/230/10K/i LS DI	12	—
142783	PZ 1000/400 V A5	33	14
142784	PZ 1000 K D20	33	14
142897	Z 400 M K VS-Power	27	14
146990	Z 750 S	28	14
147230	SP 230/10 K	9	1,14
147233	SP 3/230/10 K	9	15
147240	SP230/10 K/HS/i	10	—
147707	Z 400 M VS-Power	27	14
149820	ESB-6K	14	14
149821	ESB-16HS	14	—
149822	ESB-6K_1A	14	14
149830	DI-5A	12	—
149992	SU 1-10 V K	36	14
149993	PR 1-10 V K LC	36	14
163683	L 4/6/8.304	86	1,19,25
163694	L 7/9/11.307	86	1,19,25,31
163711	LN 13.313	86	1,19,25,31
163730	LN 16.316	86, 88	1,25
163763	LN 181.319	88	1,19,25,31
163861	LN 15.329	88	1,25
164013	L 25.346	88	1
164335	L 7/9/11.411	86	1
164342	LN 13.413	86	1
164572	LN 18.510	88	1
164590	LN 36.511	88	1
164680	LN 30.530	88	—

- 1  ENEC
1a applied
- 2 
- 3 
- 5 
- 7 
- 13 
- 13a 
- 14  VDE
14a applied
- 15 
- 16 
- 17 
- 19 
- 25 
- 28 
- 31  
- 32 
- 33 
- 34 
- 35 
- 36 

Reference Numbers

Ref. No.	Type	Page	Approval
164828	L 58.625	89	—
164870	L 58.657	89	—
169389	LN 58.568	88	1
169645	LN 30.801	88	1
169779	LN 36.570	88	1
183033	EHXc 35.325	8	1,14,28
183035	EHXc 35.325	8	1,14,28
183036	EHXc 70.326	8	1,14,28
183038	EHXc 70.326	8	1,14,28
186072	EST 70/12.380	158	1,14,28
186077	EST 105/12.381	158	1,14,28
186098	EST 150/12.622	158	1,14,28
186173	EST 60/12.635	158	13
188095	ELXc 149.858	82	1,14,28
188140	ELXc 140.862	80, 82	1,14,28
188142	ELXc 154.864	82	1,14,28
188144	ELXc 180.866	80, 82	1,14,28
188616	ELXc 240.863	80, 82	1,14,28
188617	ELXc 249.859	82	1,14,28
188618	ELXc 254.865	80, 82	1,14,28
188619	ELXc 280.538	80, 82	1,14,28
188704	ELXc 136.207	83	14
188705	ELXc 236.208	83	14
188707	ELXc 258.210	83	14
188792	EMXs 180.000	219	36
188793	EMXs 180.001	219	36
188794	EMXs 180.002	219	36
188795	EMXs 180.003	219	36
188823	Battery 4.8V 1.8Ah NiCd	219	—
188824	Battery 4.8V 4.5Ah NiCd	219	—
188825	Battery 4.8V 1.8Ah NiMH	219	—
188826	Battery 4.8V 4.5Ah NiMH	219	—
188827	Battery holder	219	—
188828	Battery holder	219	—
188829	Battery holder	219	—
188921	ELXc 135.220	83	14,28
188922	ELXc 235.221	83	14,28
400772	80476	201	—
400779	80475	201	—
400817	85076	178	—
400818	85076	178	—
400819	85077	187	—
400820	85077	187	—
400913	12600	44	1
400914	12601	44	1
400915	12610	44	1
400916	12611	44	1
400917	12614	45	1
400918	12612	45	1
401536	94444	201	—
401549	94438	201	—
500574	35613	94	1,3
500757	84001	106	—
500810	64401	184	1,33
501356	64601	184	1,33
501358	64601	184	1,33
501942	97268	168	—
502004	33500	168	1,34

Ref. No.	Type	Page	Approval
502064	97320	169	—
502111	31020	169	1,3
502112	31030	169	1,3
502416	97282	170	—
502515	83301	198	—
503041	64781	185	1,33
503457	97000	179	5
503458	97000	179	5
503579	97322	178	—
503923	64201	176	1,33
503924	64201	176	1,33
504078	98011	107, 114	—
504302	64719	184	1,33
504303	64719	184	1,33
504615	97321	186	—
504640	83226	195	—
504641	83226	195	—
504643	83227	195	—
504644	83227	195	—
504749	96021	199	—
504769	83283	188	—
504938	97277	100	—
504939	97278	100	—
505014	64770	42	1,33
505251	93088	173	15
505720	64719	42	1,33
505732	09404	104	1,3
505733	09405	104	1,3
505734	09406	104	1,3
505737	09420	105	1,3
505739	09421	105	1,3
505747	09440	105	1,3
505751	09460	106	1,3
505951	83310	168	—
506026	09606	203	—
506027	09606	203	—
506247	64360	177	1,33
506249	64360	177	1,33
506255	64775	185	1,33
506257	64775	185	1,33
506263	64785	185	1,33
506265	64785	185	1,33
506360	Capacitor 85 µF	147	1
506363	Capacitor 100 µF	147	1
506807	93089	173	15
507049	81018	182	—
507050	81018	182	—
507052	81017	183	—
507053	81017	183	—
507075	83283	188	—
507490	97257	162, 168	—
507797	97267	202	—
507798	97267	202	—
508067	97037	179	5
508186	LN 58.116	88	1
508352	96004	182	—
508353	96004	182	—
508458	05202	168	—





















- 1  ENEC
1a applied
- 2 
- 3 
- 5 
- 7 
- 13 
- 13a 
- 14  VDE
14a applied
- 15 
- 16 
- 17 
- 19 
- 25 
- 28 
- 31 
- 32 
- 33 
- 34 
- 35 
- 36 

- 1
- 2
- 3
- 4
- 5
- 6
- 7
- 8
- 9
- 10

Reference Numbers

Ref. No.	Type	Page	Approval
508484	Capacitor 25 µF	146	1
508562	97355	173	15
508563	97356	173	15
509263	64307	177	1,33
509295	97355	173	15
509296	97356	173	15
509373	L 36.120	89	—
509502	LN 26.813	88	1,31
509520	93058	99	—
509522	93056	99	—
520735	85074	179	—
520736	85074	179	—
520759	97708	179	—
520760	97708	179	—
520880	94455	167	—
521123	84105	115	1,3
525583	97760	168	—
526169	Capacitor 4 µF	146	1
526170	Capacitor 6 µF	146	1
526171	Capacitor 8 µF	146	1
526172	Capacitor 12 µF	146	1
526886	97497	186	—
528252	12900	45	—
528253	12910	46	—
528254	12911	46	—
528552	Capacitor 20 µF	146	1
528554	Capacitor 35 µF	146	1
528555	Capacitor 45 µF	146	1
528582	L 18.121	89	1
528958	12901	45	—
529029	LN 36.149	88	1
529599	64740	185	1,33
529665	Capacitor 10 µF	146	1
529666	Capacitor 16 µF	146	1
529836	84103	107	—
530252	L 36.158	89	14
530878	11000	100	1,3,33
530879	11010	100	1,3,33
530941	LN 18.131	88	1
532390	97545	187	—
532391	80023	187	—
532430	13010	49	1
532431	13010	49	1
532602	12800	45, 204	1
532603	12801	45, 204	1
532604	12810	45, 204	1
532605	12811	45, 204	1
532606	12812	45, 204	1
532610	33906	167	1
533313	41510	119	1,17
533314	41520	119	1,17
533316	41550	119	1,17
533317	41560	119	1,17
533428	12600	44	1
533429	12601	44	1
533430	12610	44	1
533431	12611	44	1
533432	12612	45	1





















Ref. No.	Type	Page	Approval
533663	37001	46	1
533818	64308	177	1
534073	84108	107	1,3
534097	97632	202	—
534252	LN 58.722	89	1
534584	L 36.124	89	14
534624	L 18.933	89	—
534627	L 18.936	89	—
534689	98013	200	—
534832	62063	194	1
534833	62063	194	1
534948	41530	119	1,17
534954	41570	119	1,17
535684	62061	194	1
535685	62061	194	1
535750	42200	46	1,34
535751	42210	46	1,34
535755	42222	47	1
535977	L 36.132	88	14
536220	12614	45	1
536379	Capacitor 4 µF	147	1
536380	Capacitor 6 µF	147	1
536381	Capacitor 8 µF	147	1
536382	Capacitor 10 µF	147	1
536383	Capacitor 12 µF	147	1
536386	Capacitor 18 µF	147	1
536387	Capacitor 20 µF	147	1
536388	Capacitor 25 µF	147	1
536389	Capacitor 30 µF	147	1
536390	Capacitor 32 µF	147	1
536392	Capacitor 40 µF	147	1
536393	Capacitor 45 µF	147	1
536394	Capacitor 50 µF	147	1
536396	Capacitor 60 µF	147	1
536400	Capacitor 32 µF	147	—
536401	Capacitor 37 µF	147	—
536402	Capacitor 50 µF	147	—
536404	Capacitor 60 µF	147	—
536405	Capacitor 85 µF	147	—
536451	62062	194	1
536452	62062	194	1
536743	Capacitor 30 µF	146	1
537058	Capacitor 65 µF	147	1
538072	L 361.342	88	1
538089	09700	202	—
543303	62370	44, 194	1
543304	62070	43, 193	1
543402	Capacitor 13.5 µF	146	1
543643	42242	47	1
543770	40560	121	1
543771	40561	121	1
543772	40562	121	1
543773	40563	121	1
543777	40566	121	1
543778	40567	121	1
543781	40570	121	7
543782	40571	121	7
543783	40572	121	7

- 1  ENEC
1a applied
- 2 
- 3  UL US
- 5 
- 7 
- 13 
- 13a 
- 14  VDE
14a applied
- 15 
- 16 
- 17 
- 19 
- 25 
- 28 
- 31  
- 32 
- 33 
- 34 
- 35 
- 36 

Reference Numbers

Ref. No.	Type	Page	Approval
543783	40572	121	7
543784	40573	121	7
543787	40576	121	7
543788	40577	121	7
543793	40660	120	1
543794	40661	120	1
543795	40662	120	1
543796	40663	120	1
543800	40666	120	1
543801	40667	120	1
543802	40670	120	7
543803	40671	120	7
543805	40672	120	7
543806	40673	120	7
543809	40676	120	7
543810	40677	120	7
544605	62009	43, 193	1
544621	64800	199	—
545894	09446	105	1,3
545896	09447	106	1,3
545933	09432	105	1,3
545935	09433	105	1,3
545937	09434	105	1,3
545939	09435	105	1,3
546454	64370	176	1,33
546456	64370	176	1,33
546641	27700	108	1,3
546642	27701	108	1,3
550375	83142	182	1
551644	Capacitor 18 µF	146	1
554270	JD 2000.81	18	—
554283	JD 2000.83	18	—
554303	J 2000.71	18	—
554304	J 2000.72	18	—
554305	J 2000.73	18	—
554306	JD 2000.81	18	—
554307	JD 2000II.91	18	—
554308	JD 2000II.92	18	—
554309	JD 2000I.85	18	—
554310	JD 2000I.86	18	—
554311	J 1200.95	18	—
554312	J 2500.96	18	—
554313	VNaHJ 1000.75	19	—
554314	VJ 2000.76	19	—
554315	VJD 2000.77	19	—
554316	VJD 2000I.78	19	—
554904	VNaHJ 1000.75	19	—
554905	VJ 2000.76	19	—
554906	VJD 2000.77	19	—
554909	VJD 2000I.78	19	—
560664	INN 36.648	90	—
564680	64770	189	—
564681	64770	189	—
565816	64380	177	1
569031	INN 58.960	90	—
570958	NaH 50.654	15	—
570961	NaHJ 35.638	15	—
570962	NaHJ 70.653	15	—





















Ref. No.	Type	Page	Approval
570963	NaHJ 250.915	15	—
570964	NaHJ 100.941	15	—
570965	Q 80.510	20	—
570966	Q 125.512	20	—
570967	Q 250.513	20	1
570968	Q 80/50.551	20	—
570969	Q 125.568	20	1
570970	Q 80.584	20	—
570971	Q 400.612	20	1
570972	Q 250.528	20	1
570973	Q 400.669	20	—
570974	NaHJ 150.995	16	—
570975	NaHJ 70.158	16	—
570976	Q 125.549	20	—
570977	NaHJ 70.300	15	—
570978	NaHJ 250.340	15	—
570980	NaHJ 100.941	16	—
570981	Q 125.598	20	—
570982	NaHJ 250.340	15	—
570993	NaHJ 250.915	16	—
570994	NaHJ 150.995	16	—
570995	NaHJ 70.158	16	—
570996	Q 250.703	20	—
570997	NaHJ 100.126	15	1
570998	Q 400.613	20	1
570999	NaHJ 150.679	15	—
571000	Q 400.616	20	—
571003	Q 250.606	20	—
571004	NaHJ 150.159	15	1
571006	NaHJ 250.204	15	1
571008	NaHJ 70.128	15	1
571009	NaHJ 70.128	16	1
571010	NaHJ 70.128	16	1
571011	NaHJ 70.226	16	—
571012	NaHJ 70.226	16	—
571013	NaHJ 150.620	15	1
571015	NaHJ 150.620	16	1
571018	NaHJ 70.128	15	—
571019	NaHJ 150.620	15	—
571020	NaHJ 70.128	16	—
571022	NaHJ 70.128	15	—
571023	NaHJ 150.620	16	—
571025	NaHJ 150.166	16	—
571028	NaHJ 100.941	16	—
571031	NaHJ 100.213	16	—
571042	NaHJ 250.727	17	—
571043	NaHJ 1000.089	17	—
571044	NaHJ 400.006	17	1
571045	NaH 600.010	17	1
571046	NaHJ 1000.089	17	1
571047	NaHJ 400.006	17	—
571048	NaHJ 1000.089	17	1
571049	NaHJ 250.727	17	—
571050	NaHJ 400.737	17	—
571051	NaHJ 1000.089	17	—
571052	NaHJ 250.727	17	—
571053	NaHJ 400.737	17	—
571054	NaHJ 400.737	17	—

1	
	ENEC 1a applied
2	
3	
5	
7	
13	
13a	
14	
	VDE 14a applied
15	
16	
17	
19	
25	
28	
31	
32	
33	
34	
35	
36	

1
2
3
4
5
6
7
8
9
10

Reference Numbers

Ref. No.	Type	Page	Approval
571055	NaH 600.005	17	—
571056	NaHJ 1000.089	17	—
571057	NaHJ 400.012	17	—
571058	NaH 600.140	17	1
571074	NaHJ 35.485	15	—
571075	NaHJ 35.485	16	—
571076	NaHJ 35.209	16	—
571077	NaH 50.486	15	—
571078	NaH 50.486	16	—
571080	Q 125/80.611	20	—
571081	NaHJ 70/50.157	16	—
571085	NaHJ 70/50.695	16	—
571244	NaHJ 150/100.973	16	—
571249	NaHJ 250.163	15	—
571254	Q 1000.311	21	—
571255	Q 1000.096	21	—
571256	Q 1000.145	21	—
571257	Q 1000.097	21	—
571653	Capacitor 2.5 µF	146	1
571654	Capacitor 4.5 µF	146	1
571655	Capacitor 9 µF	146	1
571656	Capacitor 40 µF	146	1
571657	Capacitor 50 µF	146	1
571658	Capacitor 55 µF	146	1
571659	Capacitor 60 µF	146	1
571660	Capacitor 65 µF	146	1
on requ.	64314	177	

- 1  ENEC
1a applied
- 2 
- 3  US
- 5 
- 7 
- 13 
- 13a 
- 14  VDE
14a applied
- 15 
- 16  TUV
TUV Approved
Energy
Efficient
Products
TUV
SÜD
- 17 
- 19 
- 25 
- 28  VDE
EMC
- 31  RAM 
- 32 
- 33 
- 34  US
- 35  ETL
RECOGNIZED
COMPONENT
US
- 36  DEKRA

Subsidiaries

Subsidiaries	Adress	Phone / Fax / Email
Vossloh-Schwabe Deutschland GmbH Germany, Benelux, CIS, Georgia, Great Britain, Ireland, Austria, Switzerland, Scandinavia, Ukraine	Wasenstrasse 25 73660 Urbach, Germany	Phone: +49/(0)7181/80 02-0 Fax: +49/(0)7181/80 02-122 info.vsv@vossloh-schwabe.com
Australia, New Zealand Vossloh-Schwabe Deutschland GmbH	Branch Office Sydney Unit 4C, 6 Boundary Road Northmead, NSW, 2152, Australia	Phone: +61 (0)2 88 43 07 00 Fax: +61 (0)2 7803 9213 vs.sales@vsausa.com.au
China Vossloh-Schwabe Lighting Solutions (Zhuhai) Ltd.	Room 503, Tower A, Site 1 Hengqin International Innotech Center, No. 418 Houpu Road, Hengqin New Area, Zhuhai, China	Phone: +86/756 6842737
East Europe & Turkey Vossloh-Schwabe Deutschland GmbH	Sales office Serbia Karl Rojrn b.b. 35210 Svilajnac, Serbia	Phone: +381 35 8150 122 Phone: +49 7181 8002 835 sales.ee@vossloh-schwabe.com
France Vossloh-Schwabe Deutschland GmbH	Branch Office France 10 Rue Denis Papin CS50101 68025 Colmar, France	Phone: +33/(0)389/20 12 12 Fax: +33/(0)389/24 18 65 commercial@vossloh-schwabe.com
Hong Kong, Asian Region Vossloh-Schwabe Hong Kong Ltd.	Room B5, 17/F., TML Tower 3 Hoi Shing Road, Tsuen Wan, N.T., Hong Kong	Phone: +852/2877 9688 Fax: +852/2877 9933 sales.vshk@vossloh-schwabe.com
Italy Vossloh-Schwabe Italia S.p.A.	Via Strada S. Martino 15 47027 Sarsina/Forlì-Cesena, Italy	Phone: +39/0547/9 81 11 Fax: +39/0547/9 82 60 vs-i@vossloh-schwabe.com
South Africa Vossloh-Schwabe Deutschland GmbH	Branch Office Johannesburg 154, Lechwe Avenue, Corporate Park Midrand 1685, South Africa	Phone: +27/11/31 44 340 Fax: +27/11/31 45 287 reinhard.koegel@vossloh-schwabe.com
Spain, South America, Portugal Vossloh-Schwabe Ibérica, S.L.	Venezuela 105, 5° - A 08019 Barcelona, Spain	Phone: +34/93/481 70 70 Fax: +34/93/481 70 71 vse@vossloh-schwabe.com
Thailand Vossloh-Schwabe Trading Ltd.	3rd Floor, Unit 1, Bangkok Union Insurance Bldg. 175-177 Surawong Road, Kwaeng Suriyawong Khet Bangrak, Bangkok 10500, Thailand	Phone: +66 2634-7311 Fax: +66 2634-7313 nipaporn.meepa@vossloh-schwabe.com
USA, Canada, Mexico Universal™ Lighting Technologies	26 Century Blvd. Nashville, TN 37214-3683, USA	Phone: +1/615/316-5100 Fax: +1/615/316-5205 oem_sales@unvlt.com

Whenever an electric light goes on around the world, Vossloh-Schwabe is likely to have made a key contribution to ensuring that everything works at the flick of a switch.

Headquartered in Germany, Vossloh-Schwabe counts as a technology leader within the lighting sector. Top-quality, high-performance products form the basis of the company's success.

Vossloh-Schwabe's extensive product portfolio covers all lighting components: LED systems with matching control gear units, highly efficient optical systems, state-of-the-art control systems (Blu2Light and LiCS) as well as electronic and magnetic ballasts and lampholders.

The company's future is Smart Lighting.

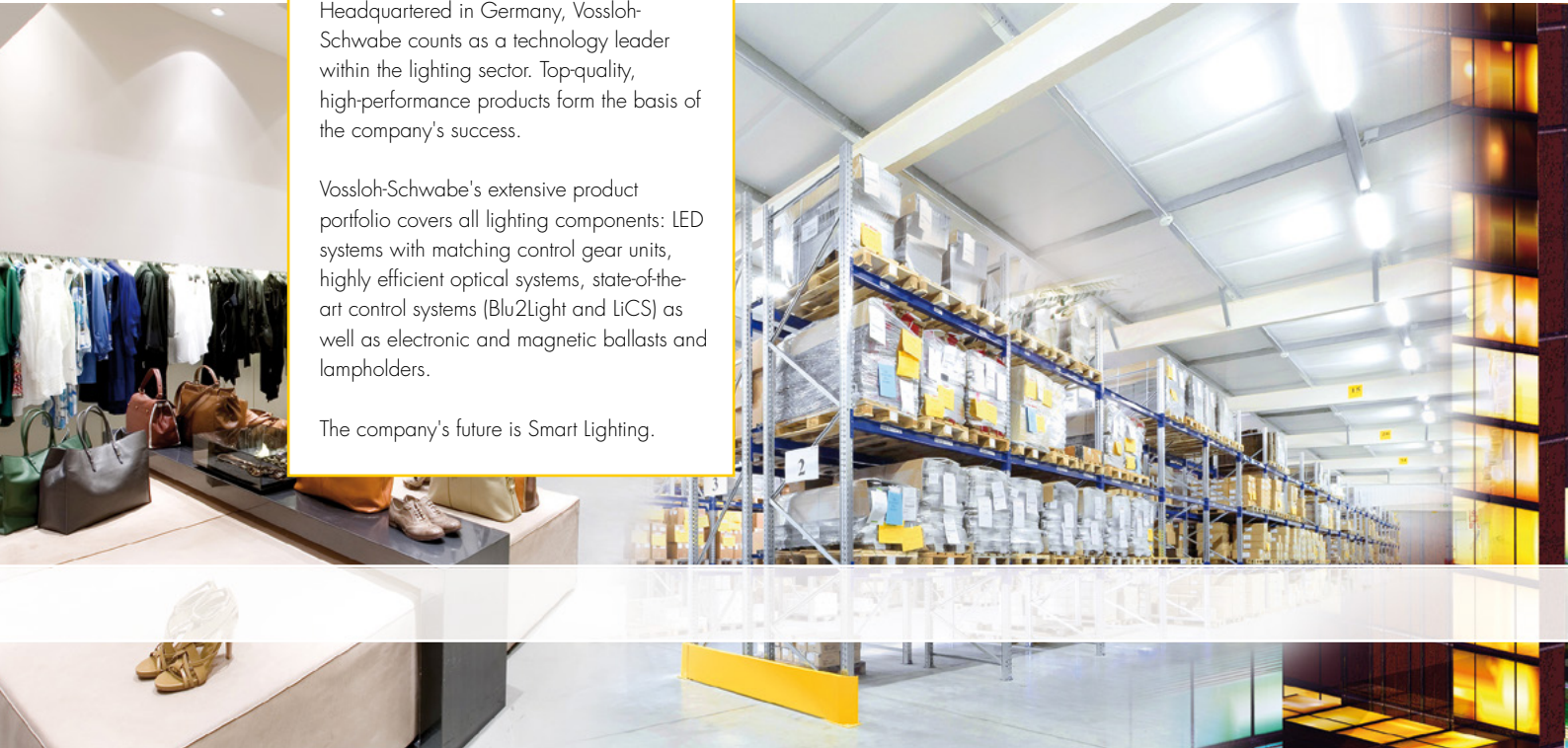

Vossloh-Schwabe Deutschland GmbH

Wasenstraße 25 · 73660 Urbach · Deutschland
Telefon +49/(0)71 81/80 02-0 · Fax +49/(0) 71 81/80 02-122

www.vossloh-schwabe.com



All rights reserved © Vossloh-Schwabe
Photos: istockphoto.com; shutterstock.com
Specifications are subject to change without notice
VS Component Systems Standard EN 2021